





Research Article

Application of Tramadol Hydrogel as a Transdermal Drug Delivery with Sonophoresis Device to RatsSitem Merve Şahin^{1,2} , Güleğül Duman³ , Ece Genç⁴ , Alper Yaman⁵ , Elif Çiğdem Altunok⁶ 

¹Biotechnology, Institute of Science and Technology, Yeditepe University, Istanbul, Turkey, ²Bioengineering, Institute of Science and Technology, Hacettepe University, Ankara, Turkey, ³Pharmaceutical Technology, Institute of Science and Technology, Yeditepe University, Istanbul, Turkey, ⁴Department of Pharmacology, Faculty of Medicine, Yeditepe University, Istanbul, Turkey, ⁵Biomechanotronics, Fraunhofer Institute for Manufacturing Engineering and Automation, Stuttgart, Germany, ⁶Statistics, Faculty of Medicine, Yeditepe University, Istanbul, Turkey

Abstract: Transdermal drug delivery offers an appealing alternative to injections and oral medications. However, applications of transdermal drug delivery are constrained to only a few drugs due to low skin permeability. Application of low-frequency ultrasound enhances skin permeability, a phenomenon called as low-frequency sonophoresis. The skin consists of two important layers called epidermis and dermis, which are on the fatty layer called hypodermis (subcutaneous tissue). The epidermis is the outermost layer of the skin. It consists mainly of cells called “keratinocytes”. This is caused by the evolution of cells formed in the lower layer and their accumulation on top of each other. At the top is the stratum corneum epidermidis layer from almost completely dead cells. Stratum corneum acts as a primary barrier to drug delivery, transdermal drug delivery technique precedes to conventional drug delivery process. In this study, tramadol hydrogel is an opioid-like analgesic with much less adverse impact was carried out to rat skin. The tramadol hydrogel was applied on rat skin by using a novel developed sonophoretic device. There were 4 groups of Sprague Dawley male rats that were examined to evaluate analgesia. The first group was control group, the second was intraperitoneal (i.p.) application group, the third was tramadol hydrogel without sonophoresis application and the last group was tramadol hydrogel with sonophoresis application. It was shown that tramadol used with sonophoresis increased analgesic effect three-fold than tramadol hydrogel group 30 minutes later. Hot-plate analgesia meter was used and the efficacy was measured on 16 rats. Tramadol dosage was 28 mg per kilogram for each rat. Low frequency sonophoresis device transducer was adjusted to 40 kilohertz (kHz) frequency for up to 60 minutes. Measurements were carried out at 0, 10, 20, 30, 40 and 60 minutes. There was a statistically significant difference between tramadol hydrogel and tramadol hydrogel with sonophoresis groups ($p < 0.05$, by Kruskal Wallis test). Moreover, the developed sonophoretic device application was successful and application low frequency 40 kHz was safe. Neither burn nor erythematous streaks were observed on rat skin by using low frequency sonophoresis. The administration of tramadol hydrogel and tramadol hydrogel with sonophoresis groups were examined, the absorption of tramadol increased by 2-3 times transdermally.

Keywords: *Tramadol hydrogel; hot plate analgesia test; sonophoresis device; transdermal drug delivery; Sprague Dawley rats; low frequency*

Address of Correspondence: Sitem Merve Şahin - mervebiyomedikal@gmail.com  0000-0003-3966-4333, Biotechnology, Institute of Science and Technology, Yeditepe University, Istanbul, Turkey, 34755, Istanbul, Turkey, Güleğül Duman  0000-0002-3266-582X; Ece Genç  0000-0002-9788-1101; Alper Yaman  0000-0003-1767-4020, Çiğdem Altunok  0000-0002-2479-1236

1. Introduction

The skin is one of the most critical organs inside the frame and takes a huge role for penetration of drug delivery structures (Trommer and Neubert, 2006). Transdermal drug delivery systems have essential advantages. Transdermal drug release has many advantages. These advantages are as following: drug release is provided non-invasively, the degradation of gastrointestinal (GI) enzymes is avoided, the transdermal drug release system does not produce “first-pass effect” in the liver, systemic toxicity decreases, drug absorption is provided by manipulation, drug bioavailability increases, plasma drug level is maintained as constant, it is given as an analgesic to patients who have moderate or strong pain. The transdermal drug delivery system adjusts the frequency and amount of drug dosing, damages tissues less and is cost-effective (Paudel et al., 2010). The skin talents as a barrier to inhibit drug delivery, stratum corneum layer is that the outermost layer of the skin, has a structure in which corneocytes are densely packed in a lipid matrix, forming the ‘bricks and mortar’ and that is the first crucial barrier (Lampe et al., 1983). The stratum corneum of base layer is known as granular layer is the formation of mobile cell junction which block the drug from penetrating via the structure. The drug penetrates the stratum corneum initially, secondly passes were through the deeper epidermis. Thanks to this penetration, in the dermal layer there is no drug accumulation (Guy and Hudgraft, 2003). Elimination half-life of tramadol is about 6 hours (Lehmann et al., 1997). Tramadol has a high solubility in the oral cavity. It is also known as tramadol hydrochloride prepared with Pluronic 127, it has both opioid and non-opioid properties (Mitragotri et al., 2010). It is primary effective at the central nervous system (CNS). According to the structure tramadol is similar to codeine and morphine. It has 6000-times less side effect than morphine and is 10-times less powerful than codeine (Thang et al., 2001). It provides serotonin (5-HT) reuptake due to inhibition of ache distribution inside the spinal cord (Bamigbade and Langford, 1998). Sonophoresis facilitates to penetrate from stratum corneum absorption (Schoellhammer et al., 2014). Fellinger and Schmidt published an article on sonophoresis in early 1950s for the treatment of polyarthritis. It was applied hydrocortisone on the hand’s digital joints (Smith et al., 2007). This technique provided us better results considered to hydrocortisone injections for bursitis treatment (Liu et al., 2006). Sonophoresis can also be applied on a variety of drugs which have capability to assist the penetration as well. One of the most important applications of this method is for local anesthetics transdermal application (Mitragotri et al., 2014). Transdermal drug release has been examined in 2 subgroups as active and passive methods (Kurz et al., 1989). Passive methods are that the optimization of the drug method or delivery to enhance skin permeability (Smith et al., 1995). However, these techniques have limits for the development of the skin permeability of bio-macromolecules (Bartek et al., 1987). On the contrary, the active strategies which comprise of physical or mechanical techniques even for bio-macromolecules (Ferryhough et al., 1992). These techniques

are micro-needles, iontophoresis, chemical penetration enhancers and sonophoresis. There are four main ultrasound parameters which are frequency, intensity, duty cycle, and application of time. Low-frequency sonophoresis has an important breakthrough on the formation and collapse of gaseous cavities (acoustic). Moreover, with the usage of acoustic spectroscopy, quantifying inertial cavitation has become more handy (Tezel et al., 2002). It can produce intense micro streams, that is going up the bioavailability of the drugs (Terahara et al., 2002). Cavitation takes place due to the nucleation of small gaseous cavities all through the negative stress cycles of ultrasound. As a result, cavitation provides the ordering of the lipid bilayers and formation of aqueous channels ensures to penetrate easily in the skin (Mitragotri et al., 1995). Levy et al. demonstrated that when convection and cavitation had been mixed with mannitol, inulin, they enhanced transport to skin (Levy et al., 1989). Mitragotri et al. carried out a work of the synergistic effect of low-frequency ultrasound that is using 20 kHz with sodium lauryl sulfate (SLS) (Levy et al., 1989). The addition of 1% SLS to the solution reduced the threshold to about 18 joules/cm² (Mitragotri, 2000).

1.1. Low-Frequency Sonophoresis

Biotechnology has its milestone on low-frequency sonophoresis which has studied by scientist for the last 10 years. Sonophoresis provides electrical energy to turn into mechanical energy or vice versa. Low-frequency sonophoresis helps to increase diffusion and ultrasound waves causes convection. The most powerful feature of low-frequency sonophoresis is measuring frequency and drug delivery ratio which can be controlled by an ultrasonic transducer. Low-frequency sonophoresis helps to delivery of low and high molecular (macromolecule like heparin and glucose) of drugs which includes hydrophilic drugs. Hence, it has an important technique for drug delivery systems.

Low-frequency sonophoresis presents advantages over other transdermal delivery methods. It can be tested by application time and ultrasound parameters (Mitragotri, 2000). So it provides local delivery. The other advantage is that it can be controlled by varying frequency and intensity of ultrasound. The other advantage is that it can also be used with drug-containing patch. It is the effective release of prescribed medications cannot be easily achieved by conventional patches, since the dose may be discharged or released. For the solution of this problem, controlled therapeutic systems are preferred by physical means. It can monitor blood analyses as well as blood glucose for diabetes (Kost et al., 2000).

Low frequency sonophoresis was used for therapeutic purposes with the help of piezoelectric disc, it is formed by the addition of mechanism. When rapid change in voltage with transducer motion, it provides therapeutic penetration of drug. It consists of high frequency pressure wave (ultrasound). The active substance is provided from the ultrasound device. It is provided by a contacting agent which transmits energy to the skin. Mechanical changes in the skin affect the stratum corneum layer of the skin. This mechanical change takes place in keratinocyte cells thanks to cavitation (cavity formation), allowing permeation and cell destruction increases rapidly in a reversible way.

1.2. Dependence of Transport on Ultrasound Parameters

Ultrasound links to skin barriers. These barriers are stratum corneum thickness, high skin impedance, low skin hydration, low useable area for solid transportation, age, blood flow, follicles such as sweat and hair, trauma on skin, humidity and temperature, presence of chemicals and chronic usages of drugs.

There are four main ultrasound parameters which are frequency, intensity, duty cycle, and application of time. Low-frequency sonophoresis has an extensive study on the dependence of permeability enhancement on frequency and intensity in the low-frequency which has been shown by Tezel et al. (Tezel et al., 2001).

1.2.1. The Frequency

Emitted wave frequency is related to the size of the crystal. Attenuation of an acoustic wave is inversely proportional to its frequency. If the frequency increases, ultrasound penetrates into less deeply under the skin. High frequencies range from 1-3 Mhz while low frequency ranges from 20 to 100 kHz. High frequencies were first surveyed as physical enhancers for transdermal delivery of drugs (Neeter et al., 2003).

1.2.2. Mechanisms of Low-Frequency Sonophoresis

Many of variables affect low-frequency sonophoresis. These are cavitation (pore induction), frequency, amplitude, intensity and application of time.

1.2.3. Cavitation

Low-frequency sonophoresis has an important breakthrough on the formation and collapse of gaseous cavities (acoustic). Cavitation means the collapse and formation of gas bubbles in a liquid environment and the resulting collapse when exposed to a sound wave in such an environment. Cavitation happens with the coupling medium (coupling medium means liquid is that found between the ultrasound transducer and the skin). The frequency and acoustic pressure amplitude are related to the maximum radius of the cavitation bubbles. During low-frequency sonophoresis, cavitation occurs within 15 micrometers of stratum corneum and in order to overcome this, inert cavitation is created in the skin layers. Moreover, with the usage of acoustic spectroscopy, quantifying inertial cavitation has become more manageable (Husseini et al., 2005). It can produce violent micro streams, which goes up the bioavailability of the drugs. As a result, cavitation provides the ordering of the lipid bilayers and formation of aqueous channels provides to penetrate easily in the skin.

1.2.4. Convection

Convection is a significant factor for low-frequency sonophoresis. Acoustic streaming (convective process) can be increased by lidocaine. Levy et al., 2014, demonstrated that when convection and cavitation were mixed with mannitol, inulin, they enhanced delivery to skin.

1.2.5. Thermal Effects

Attenuation of ultrasound wave leads to thermal increase for low-frequency sonophoresis. Ultrasound waves cause heating of the medium. Thermal effects cause to increase skin permeability. It provides to increase kinetic energy and diffusion of drugs, dilates points of entry of the skin, promotes drug absorption and enhances circulation of blood for *in vivo* experiments. Duty cycle and ultrasound intensity are parameters that are directly related to thermal effects. Therefore, these parameters must be arranged for low-frequency sonophoresis application.

1.2.6. Synergistic Effect with Other Enhancers

Ultrasound application is not effective compared to usage of low-frequency ultrasound combinations with other enhancers which has been shown to be more efficient. Moreover, increasing transdermal transport, especially with the combination of ultrasound with other enhancers causes to decrease the enhancers needed to help the drug flux. Therefore, combination of ultrasound with other enhancers will definitely increase the reliability with decreasing the strength of selected enhancers.

1.2.7. Ultrasound and Chemicals

Mitragotri et al. carried out a work of the synergistic effect of low-frequency ultrasound that is using 20 kilohertz with SLS (Hama and Sagen, 2007). It has been shown that the administration of SLS causes an approximately 3-fold increase in mannitol permeability and is only about 8-times greater than that of ultrasound for 90 minutes. It was also observed that the induced sulphate solution increased approximately 200-fold in the skin permeability of mannitol.

In particular, with insufficient surfactant penetration effect, the threshold ultrasound energy was about 141 joules/cm² to produce a detectable change in skin impedance. Mitragotri et al. has showed the addition of 1% SLS to the solution reduced the threshold to about 18 joules/cm². The various results of this synergistic effect indicated that low frequency ultrasound indicated better spread and diffusion of the surfactant in the skin.

1.2.8. Ultrasound and Iontophoresis

The synergy between low frequency ultrasound and iontophoresis are of great importance as it increases transdermal transport. In fact, this combination is particularly useful in the treatment of transdermal transport by Park et al., 2019, By using heparin as a model drug, it has been shown to have a better and easier way to investigate the synergistic effect of ultrasound and iontophoresis on transdermal transport by Long et al., 2000. Approximately 10 minutes prior to the administration of iontophoresis, the skin was once treated with 1% dodecyl pyridinium chloride solution. As a result, the increase in heparin flux of ultrasound and iontophoresis applications was recorded approximately 56-fold increased with these applications.

1.3. Equipment and Devices

1.3.1. Tramadol Pharmacology

Tramadol is a centrally acting analgesic agent with μ -opioid agonist properties, blocks NE uptake. Tramadol hydrogel is a similar molecule with 4-phenyl-piperidine analogue of codeine, which is acting as analgesic. It can be used by patients in the orthopedics spine clinic and may even be beneficial in patients with poor cardiopulmonary function, including older patients, obese and smokers, patients with liver or renal dysfunction and patients using non-steroidal anti-inflammatory disorders. It can be also used in post-operative pain relief. Its elimination half-life is about 6 hours.

Tramadol has a high solubility in the oral cavity. It is also known as tramadol hydrochloride (Tr HC) and has opioid and non-opioid properties. It is primary effective on the central nervous system (CNS). This drug is similar to codeine and morphine as considered to structurally. However, it is 6000-times less active than morphine and is 10-times less effective than codeine. However, in 1995, it was rated as a treatment of acute pain with Food and Drug Administration. Tramadol hydrochloride effects are on low-affinity m-opioid and k-opioid receptors, and NE, blocking monoamine receptor systems. It provides 5-HT reuptake due to inhibition of pain distribution in the spinal cord. It has also a lower incidence of adverse effects.

1.3.2. Hot Plate Analgesia Test

The hot plate is one of the most widely preferred test for analgesia. Because it is helpful to determine the analgesic efficacy of experimental drugs in rodents. In this experiment it was used the guidelines developed by Ankier S.I. (1974). A hot plate, May AHP 0603 is brand name, has been adjusted to 54°C and the latency of the first reaction (licking of the paws or jumping response- a jump has been identified by all 4 paws leaving the heated surface) has been recorded. A cut-off period of 60 seconds has been considered to avoid any damage to the paws. Rats were placed on the hot plate one by one and response latency was measured with a stopwatch (rats were used from YÜDETAM, Yeditepe University). Observations showed that the majority of animals reacted to the heat by licking their paws.

2. Materials and Methods

2.1. Development of Transdermal Sonophoresis Device

Transdermal sonophoresis device was developed at Yeditepe University Biomedical Engineering Laboratories. Lm555 oscillator, Texas Instrument, has been used for this experiment. On this experiment, the aim is to produce square wave pulses provided continuously by the 555 timer IC. On the other hand, the 555 timer IC has connected either in its monostable mode therefore it generates a back and front type switching action. Connection of the 555 timer IC in an unstable mode is a tricky part. When it was approved highly precise free roaming waveform, very stable 555 oscillator has to used. Also, RC circuit has to be connected to oscillator which contains 2 resistors and capacitors. The 555 timer IC can be used which generates stabilized square wave output waveforms. Its duty cycle is between 50-100%.

The device has stopped working until for the next trigger pulse. It initiates to act as an unstable multi vibrator. It has a great importance to continuously re-trigger effect of circuit. Pin 2 which provides triggering process connecting to 555 timer and threshold input to pin 6 acts as an unstable oscillator with together. Single timing resistor has a key act on this device because it has been split into two different resistors which are R1 and R2. Pin 7 which is discharge input has been linked to their junctions (Figure 3).

2.2. Tramadol Hydrogel Formulation

In this study, firstly 20 grams of Pluronic F 127 was weighed and dispersed into the 40 mL purified water. The dispersed polymer was put into the refrigerator overnight and was dissolved homogenously as a hydrogel. Then hydrogel was incubated 2 days at 37°C. The dispersed polymer was sterilized at room temperature. The solution was placed to eppendorf tube and then tramadol solution was incorporated into hydrogel. Finally, solution was sterilized at cabinet with ultraviolet for 30 minutes.

2.3. Drug Loading

The reason for mixing tramadol hydrogel with Pluronic F 127, Sigma Aldrich Chemical Co., it is more or less permeable to body fluids and also it does not avoid from transition to body fluids as useful substances such as food and oxygen. It has little friction to the surrounding tissues. It has also shown low adhesion to the mucous membrane and tissues. Epithelial cells in the stomach are protected from the acidic stomach acid thanks to the gel. Taking advantage of Blankenship's studies, it was concluded that 28 mg/kg of tramadol hydrogel was the effective dose in rats, and since each of the rats had a weight of 250 grams, 7 mg/kg was administered to each *in vivo* study.

2.4. Hot Plate Analgesia Test

Four groups were determined for measuring the analgesia effect on rats (Figure 2). The first was determined as a control group. 3 rats were placed with sonication at 40 kHz at 0, 10, 20, 30, 40 and 60 minutes. The second was tramadol hydrogel group (GT), Contramal®, Abdi İbrahim Company. In this group, only tramadol hydrogel was put on rats directly on their backs that were shaved. The third was intraperitoneal group. Each rat has administered 7 mg tramadol (28 mg/kg, each rat is 250 gram). The last was sonication application group with tramadol hydrogel was applied on rats with sonophoresis device. Tramadol hydrogel was supplied with 40 kHz ultrasonic transducer; provided with a 15 volt via power supply. In conclusion, on each time jumping or paw licking response has been noted to understand analgesic effect (Jóhannesson and Woods, 1964).

3. Result

Using low frequency sonophoresis, acoustic cavitation is created on the skin, increasing the pore and permeability on the skin. As a result of the cavitation, acoustic microjets on the skin cause inhomogeneous pore formation (Bird et al., 1960). *In vivo* experiments consisted of tramadol hydrogel and tramadol hydrogel with low frequency sonophoresis application group. Tramadol hydrogel improved drug penetration as

it provides the destruction of the organic barrier (Chaturvedi et al., 2011). A hydrogel which could stick finely to the epithelium can increase the time retention of the system at (Hussain et al., 2011). Therefore, it has provided sufficient drug dose for the desired therapeutic healing effect. (Peppas and Sahlin, 1996). Extensive efforts were made to expand bio-adhesive hydrogels to enable advanced drug delivery (Reece et al., 2001). Ultrasound-brought about disruption of ionic cross-links to set off bursts of drug launch became observed (Bouhadir et al., 2001). Low frequency sonophoresis can instant disrupt the hydrogel structure (Bommannan et al., 1992). It is very advantageous due to its deep penetration inside tissues (Mitragotri et al., 2005). No effect was observed on latency in response to acute thermal pain in any of the rats that were given transdermal tramadol as hydrogel with sonication application at initial, 10, 20 and 30 minutes later. It was calculated that the transdermal as hydrogel with sonication application is not effective until 40 minutes. Sprague Dawley rats that obtained 28 mg tramadol per kilogram body weight i.p. and transdermal packages with sonication had behavioral responses to tramadol that included minimized responsiveness to tactile stimuli and decreased cage interest no impact was discovered on latency. Acute thermal pain in any of the rats that have been given transdermal tramadol as hydrogel with sonication application at 10, 20 and 30 minutes (Taber et al., 1969).

In this study, it was found that administering 40-60 minutes sonication was found effective. The maximum latency in response to acute thermal pain that was observed after 60 minutes. The bioavailability of the transdermal hydrogel with sonication was increased almost two and three times (respectively after 40 and 60 minutes) more than transdermal hydrogel application. Hot plate latency test was used to compare latency in response to acute thermal pain after transdermal tramadol application with sonication (40 kHz) (Tilson et al., 1973). This device investigated the possibility of developing transdermal tramadol with sonication application allowing fast analgesic effect of tramadol in a 40-60 minutes (Figure1). Finally, it was observed 40 kHz was useful for this study, when the comparison with the high frequency sonophoresis, low frequency provided larger bubbles (Polat et al., 2011).

4. Discussion and Conclusion

The utility of sonophoresis to the pores and skin will increase its permeability and provides penetrating of drug substances (Tezel et al., 2003). Transdermal delivery of hydrophilic substance like tramadol causes problems due to their lack of ability of integrating with cellular membrane and penetrating through stratum corneum (Mitragotri and Kost, 2000). In this study, it was observed that the efficacy of tramadol hydrogel was increased with sonophoresis as a trigger effect after 40 minutes. Tramadol drug penetration was tested with hot plate analgesia test. Results were tested Kruskal Wallis test for statistical analysis. At the end of the study, any skin irritation was not observed with low frequency sonophoresis technique. It was safe at 1.5 W/cm² energy density and 40 kHz frequency. In this way, low-frequency sonophoresis sooner or later causes greater modifications to the skin, particularly for high-molecular weight drugs (Yu and Ding, 2008). In the simultaneous treatment, the drug and ultrasound had been performed at the same time and for this reason pores and skin transmitting changed into better diffusion as a result of structural modifications inside the skin and also because of convection ultrasound (Guvendiren et al., 2012).

Figure 1. Tramadol hydrogel (28 mg/kg) latency times in rats versus time (min) n=6. Between 3 groups tramadol hydrogel (GT), tramadol hydrogel with sonophoresis (GTS) and control group

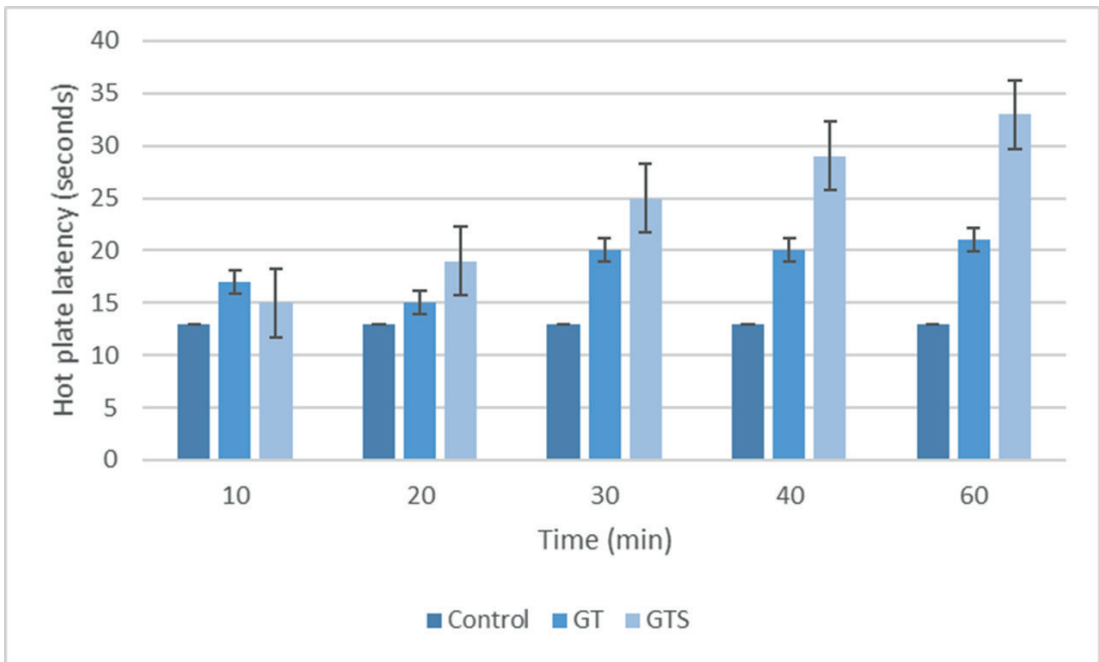

Figure 2. Sonophoresis device application to rats

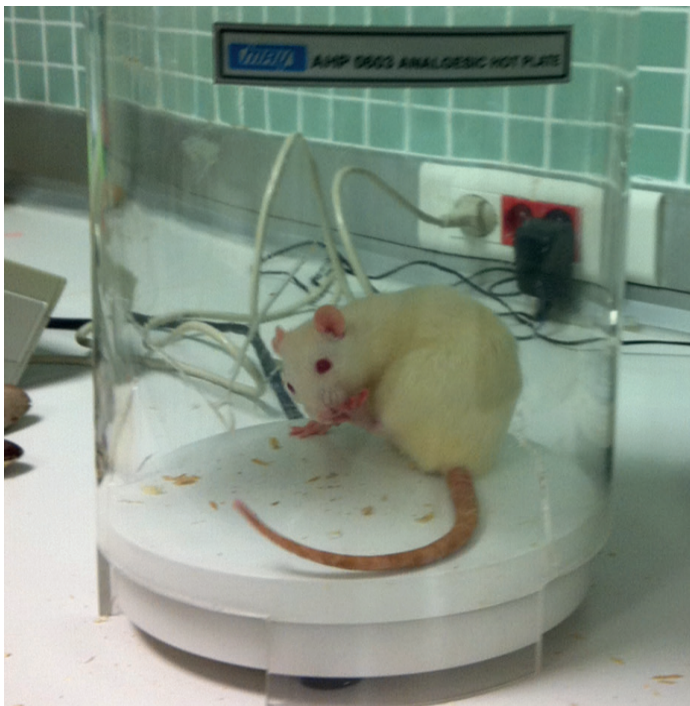
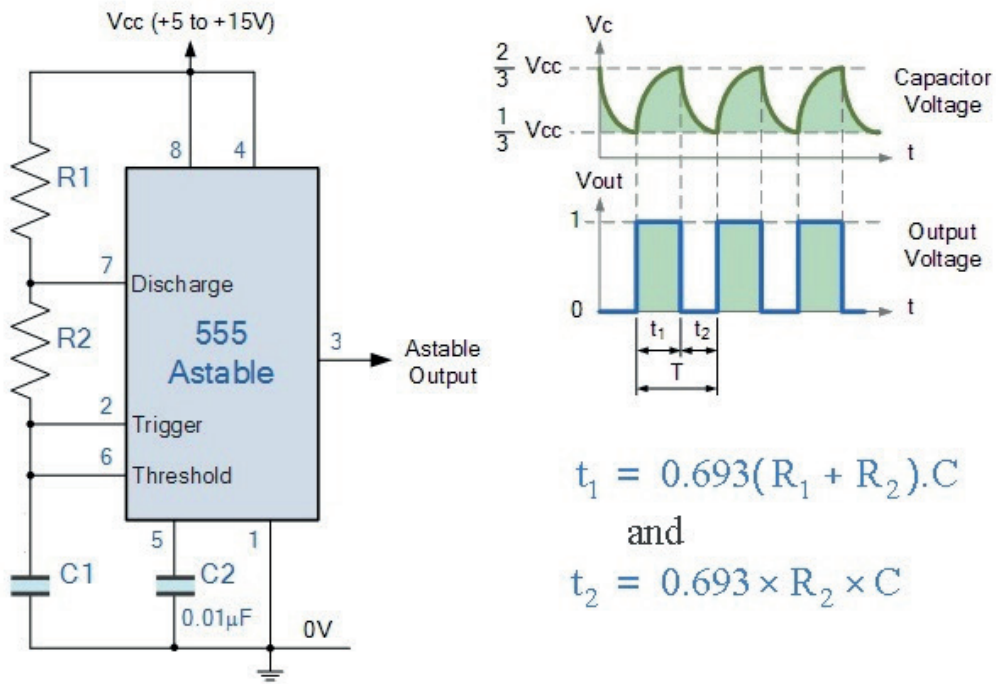

Figure 3. Sonophoresis device circuit



Acknowledgement

I want to extend my gratitude to the best university supervisor Gülelgül Duman for her continuous support during my time spent at this university. Her guidance helped me accomplish all of the research and writing for my thesis. I would like to thank all of my professors at Yeditepe University for the unrequited education that I have received.

Conflict of Interest

Authors declare no conflict of interest.

Ethical Approval

All procedures performed in studies involving experimental animals were in accordance with the ethical standards of the institutional and/or national research committee (Yeditepe University Experimental Animal Ethics Committee 01.06.2018/674).

References

- Ankier, S. I. (1974). New hot plate tests to quantify antinociceptive and narcotic antagonist activities. *European journal of pharmacology*, 27(1), 1-4.
- Bamigbade, T. A., Langford, R. M. (1998). The clinical use of tramadol hydrochloride. *Pain Reviews*, 5, 155-182.
- Bartek, M. J., Labudde, J. A. and Maibach, H. I. (1972). Skin permeability *in vivo*: comparison in rat, rabbit, pig and man. *Journal of Investigative Dermatology*, 58(3), 114-123. <https://doi.org/10.1111/1523-1747.ep12538909>
- Bird, R. B., Stewart, W. E., Lightfoot, E. N. (1960). *Transport phenomena*, 11, 5.
- Bommannan, D., Menon, G. K., Okuyama, H., Elias, P. M., Guy, R. H. (1992). Sonophoresis. II. Examination of the mechanism(s) of ultrasound-enhanced transdermal drug delivery. *Pharmaceutical Research*, 9(8), 1043-1047.
- Bouhadir, K. H., Lee, K. Y., Alsberg, E., Damm, K. L., Anderson, K. W., Mooney, D. J. (2001). Degradation of partially oxidized alginate and its potential application for tissue engineering. *Biotechnology Progress*, 17(5), 945-950. <https://doi.org/10.1021/bp010070p>
- Chaturvedi, M., Kumar, M. and Pathak, K. (2011). A review on mucoadhesive polymer used in nasal drug delivery system. *Journal of Advanced Pharmaceutical Technology & Research*, 2(4), 215. Doi: 10.4103/2231-4040.90876
- Fernyhough, J. C., Schmandle J. J., Weigel, M. C., Edwards, C. C., Levine A. M. et al. (1992). Chronic donor site pain complicating bone graft harvesting from the posterior iliac crest for spinal fusion. *Spine*, 17(12), 1474-1480. Doi: 10.1097/00007632-199212000-00006
- Guvendiren, M., Lu, H. D. and Burdick, J. A. (2012). Shear-thinning hydrogels for biomedical applications. *Soft Matter*, 8(2), 260-272. Doi: 10.1039/C1SM06513K
- Guy, R. H. (Ed.) and Hadgraft J. (Ed.) (2003). *Transdermal drug delivery*. 2nd Ed., Marcel Dekker, New York, US, Basel, CH.
- Hama, A., Sagen, J. (2007). Altered antinociceptive efficacy of tramadol over time in rats with painful peripheral neuropathy. *European Journal of Pharmacology*, 559(1), 32-37. <https://doi.org/10.1016/j.ejphar.2006.11.047>
- Hussain, T., Ranjha, N. M., Shahzad, Y. (2011). Swelling and controlled release of tramadol hydrochloride from a pH-sensitive hydrogel. *Designed Monomers and Polymers*, 14(3), 233-249. <https://doi.org/10.1163/138577211X557521>
- Husseini, G. A., Rosa, M. A. D., Richardson, E. S., Christensen, D. A., Pitt, W. G. (2005). The role of cavitation in acoustically activated drug delivery. *Journal of Controlled Release*, 107(2), 253-261. <https://doi.org/10.1016/j.jconrel.2005.06.015>

Jóhannesson, T., Woods, L. (1964). Analgesic action and brain and plasma levels of morphine and codeine in morphine tolerant, codeine tolerant and non-tolerant rats. *Acta Pharmacologica et Toxicologica*, 21(4), 381-396. <https://doi.org/10.1111/j.1600-0773.1964.tb01803.x>

Kost, J., Mitragotri S., Gabbay R. A., Pisco M., Langer, R. (2000). Transdermal monitoring of glucose and other analytes using ultrasound. *Nature Medicine*, 6(3), 347. Doi: 10.1038/73213

Kurz, L. T., Garfin, S. R., Booth Jr, R. E. (1989). Harvesting autogenous iliac bone grafts. A review of complications and techniques. *Spine*, 14(12), 1324-1331.

Lampe, M. A., Burlingame, A. L., Whitney, J., Williams, M. L., Brown, B. E., Rotman, E., Elias, P. M. (1983). Human stratum corneum lipids: characterization and regional variations. *Journal of Lipid Research*, 24(2), 120-130.

Lehmann, K. A. (1997). Tramadol in acute pain. *Drugs*, 53, 25-33. Doi: 10.2165/00003495-199700532-00007

Levy, D., Kost J., Meshulam Y., Langer R. (1989). Effect of ultrasound on transdermal drug delivery to rats and guinea pigs. *The Journal of Clinical Investigation*, 83(6), 2074-2078. Doi: 10.1172/JCI114119

Liu, C., Shao, H., Chen, F., Zheng, H. (2006). Rheological properties of concentrated aqueous injectable calcium phosphate cementslurry. *Biomaterials*, 27(29), 5003-5013. <https://doi.org/10.1016/j.biomaterials.2006.05.043>

Long, L., Kost, J., Mitragotri, S. (2000). Combined effect of low-frequency ultrasound and iontophoresis: applications for transdermal heparin delivery. *Pharmaceutical research*, 17(9), 1151.

Malana, M. A., Zohra, R. (2013). The release behavior and kinetic evaluation of tramadol HCl from chemically cross-linked ter polymeric hydrogels. *DARU Journal of Pharmaceutical Sciences*, 21(1), 10.

Mitragotri, S., Kost, J. (2000). Low-frequency sonophoresis: a noninvasive method of drug delivery and diagnostics. *Biotechnology Progress*, 16(3), 488-492. <https://doi.org/10.1021/bp000024+>

Mitragotri, S. (2005). Healing sound: the use of ultrasound in drug delivery and other therapeutic applications. *Nature Reviews Drug Discovery*, 4(3), 255-260.

Mitragotri, S., Burke, P. A., Langer, R. (2014). Overcoming the challenges in administering biopharmaceuticals: formulation and delivery strategies. *Nature Reviews Drug discovery*, 13(9), 655. Doi: 10.1038/nrd4363

Mitragotri, S., Edwards, D. A., Blankschtein, D., Langer, R. (1995). A mechanistic study of ultrasonically-enhanced transdermal drug delivery. *Journal of Pharmaceutical Sciences*, 84(6), 697-706. <https://doi.org/10.1002/jps.2600840607>

Mitragotri, S., Farrell, J., Tang, H., Yu, B., Kost, J., Blankenstein, D., Langer, R. (2000). Synergistic effect of low-frequency ultrasound and sodium lauryl sulfate on transdermal transport. *Journal of Pharmaceutical Sciences*, 89(7), 892-900. [https://doi.org/10.1002/1520-6017\(200007\)89:7<892::AID-JPS6>3.0.CO;2-V](https://doi.org/10.1002/1520-6017(200007)89:7<892::AID-JPS6>3.0.CO;2-V)

Mitragotri, S., Farrell, J., Thang, H., Terahara, T., Kost, J., Langer, R. (2000). Determination of threshold energy dose for ultrasound-induced transdermal drug transport. *Journal of Controlled Release*, 63(1-2), 41-52. [https://doi.org/10.1016/S0168-3659\(99\)00178-9](https://doi.org/10.1016/S0168-3659(99)00178-9)

Neeter, C., Thomee R., Silbernagel K. G., Thomee P., Karlsson, J. (2003). Iontophoresis with or without dexamethazone in the treatment of acute Achilles tendon pain. *Scandinavian Journal of Medicine & Science in Sports*, 13(6), 376-382. <https://doi.org/10.1046/j.1600-0838.2003.00305.x>

Park, J., Lee, H., Lim, G. S., Kim, N., Kim, D., Kim, Y. C. (2019). Enhanced transdermal drug delivery by sonophoresis and simultaneous application of sonophoresis and iontophoresis. *AAPS PharmSciTech*, 20(3), 96.

Paudel, K. S., Milewski, M., Swadley, C. L., Brogden, N. K., Ghosh, P., Stinchcomb, A. L. (2010). Challenges and opportunities in dermal/transdermal delivery. *Therapeutic Delivery*, 1(1), 109-131. <https://doi.org/10.4155/tde.10.16>

Peppas, N. A., Sahlin, J. J. (1996). Hydrogels as mucoadhesive and bioadhesive materials: a review. *Biomaterials*, 17(16), 1553-1561. [https://doi.org/10.1016/0142-9612\(95\)00307-X](https://doi.org/10.1016/0142-9612(95)00307-X)

Polat, B. E., Hart, D., Langer, R., Blankschtein, D. (2011). Ultrasound-mediated transdermal drug delivery: mechanisms, scope, and emerging trends. *Journal of Controlled Release*, 152(3), 330-348. <https://doi.org/10.1016/j.jconrel.2011.01.006>

Reece, T. B., Maxey, T. S., Kron, I. L. (2001). A prospectus on tissue adhesives. *The American Journal of Surgery*, 182(2), S40-S44. [https://doi.org/10.1016/S0002-9610\(01\)00742-5](https://doi.org/10.1016/S0002-9610(01)00742-5)

Schoellhammer, C. M., Blankschtein, D., Langeret, R. (2014). Skin permeabilization for transdermal drug delivery: recent advances and future prospects. *Expert Opinion on Drug Delivery*, 11(3), 393-407. <https://doi.org/10.1517/17425247.2014.875528>

Smith, N. B. (2007). Perspectives on transdermal ultrasound mediated drug delivery. *International Journal of Nanomedicine*, 2(4), 585

Smith, E. W., Maibach, H. I. (1995). *Percutaneous penetration enhancers*. CRC Press.

Taber, R. I., Greenhouse, D. D., Rendell, J. K., Irwin, S. (1969). Agonist and antagonist interactions of opioids on acetic acid-induced abdominal stretching in mice. *Journal of Pharmacology and Experimental Therapeutics*, 169(1), 29-38

Tang, H., Mitragotri, S., Blankschtein, D., Langer R. (2001). Theoretical description of transdermal transport of hydrophilic permeants: Application to low-frequency sonophoresis. *Journal of Pharmaceutical Sciences*, 90(5), 545-568. [https://doi.org/10.1002/1520-6017\(200105\)90:5<545::AID-JPS1012>3.0.CO;2-H](https://doi.org/10.1002/1520-6017(200105)90:5<545::AID-JPS1012>3.0.CO;2-H)

Terahara, T., Mitragotri, S., Kost J., Langer, R. (2002). Dependence of low-frequency sonophoresis on ultrasound parameters; distance of the horn and intensity. *International Journal of Pharmaceutics*, 235(1-2), 35-42. [https://doi.org/10.1016/S0378-5173\(01\)00981-4](https://doi.org/10.1016/S0378-5173(01)00981-4)

Tezel, A., Sens, A., Mitragotri, S. (2002). Investigations of the role of cavitation in low-frequency sonophoresis using acoustic spectroscopy. *Journal of Pharmaceutical Sciences*, 91(2), 444-453. <https://doi.org/10.1002/jps.10024>

Tezel, A., Sens, A., Tuscherer, J., Mitragotri, S. (2001). Frequency dependence of sonophoresis. *Pharmaceutical Research*, 18(12), 1694-1700. Doi: 10.1023/a:1013366328457

Tezel, A., Sens, A., Mitragotri, S. (2002). A theoretical analysis of low-frequency sonophoresis: dependence of transdermal transport pathways on frequency and energy density. *Pharmaceutical Research*, 19(12), 1841-1846. Doi: 10.1023/a:1021493424737

Tezel, A., Sens, A., Mitragotri, S. (2003). Description of transdermal transport of hydrophilic solutes during low-frequency sonophoresis based on a modified porous pathway model. *Journal of Pharmaceutical Sciences*, 92(2), 381-393. <https://doi.org/10.1002/jps.10299>

Tilson, H., Rech, R., Stolman, S. (1973). Hyperalgesia during withdrawal as a means of measuring the degree of dependence in morphine dependent rats. *Psychopharmacologia*, 28(3), 287-300

Trommer, H., Neubert, R. (2006). Overcoming the stratum corneum: the modulation of skin penetration. *Skin Pharmacology and Physiology*, 19(2), 106-121. <https://doi.org/10.1159/000091978>

Yu, L., Ding, J. (2008). Injectable hydrogels as unique biomedical materials. *Chemical Society Reviews*, 37(8), 1473-1481. Doi: 10.1039/B713009K