



Integral Fuzzy Sliding Mode Controller for Hydraulic System Using Neural Network Modelling

Ayca AK^{1*} , Erdal YILMAZ² , Sevan KATRANCIOGLU² 

¹Vocational School of Technical Sciences, Marmara University, Dragos, Kartal, Istanbul, TURKEY

²Turkcell Iletisim Hizmetleri, Istanbul, TURKEY

Highlights

- Control of the hydraulic system via an integral fuzzy SMC based on a RBF neural network.
- Gain adjustment of the corrective control using fuzzy logic.
- Equivalent control calculation with radial basis function neural network.
- Modelling of the hydraulic system using neural network.

Article Info

Received: 05 Aug 2021

Accepted: 23 Aug 2022

Keywords

Fuzzy logic

Hydraulic system

Neural networks

Sliding mode control

Abstract

In this paper, a hydraulic motor controller is designed with a fuzzy supported integral sliding mode algorithm. The hydraulic system used in the study was modeled using artificial neural networks. Ability of handling nonlinearity of systems makes sliding mode controller to be a good choice for this system. It is thought that the robustness of the system against uncertainties can be achieved with the help of an integral sliding mode controller. The basic concept of the suggested control method is to use fuzzy logic for adaptation of the integral sliding mode control switching gain. Such adjustment reduces the chattering that is the most problem of classical sliding mode control. The equivalent control is computed with utilizing the radial basis function neural network. The simulation results of the presented method are compared with the results of the PID controller whose parameters were obtained by means of a genetic algorithm (GA) and particle swarm optimization (PSO). It proved that it is more efficient to control the hydraulic system with integral fuzzy sliding mode control using neural network.

1. INTRODUCTION

A hydraulic motor is powerful equipment that has significant abilities such as high power-size proportion, loaded start-up capabilities as well as good durability and environmental resistance. These features make them useful in industry. However, they require sensitive control techniques because hydraulic motors have high torques. Velocity changes, especially during the start-up and stopping periods, cause excessive tension on systems driven via the motor. Thus, controlling the acceleration and deceleration of the motor as well as its steady-state reference velocity is important.

Hydraulic systems are typical nonlinear coupling systems with mechanical/hydraulic dynamics and parametric uncertainties [1]. Classical control approaches for example PD and PID are usually preferred for hydraulic systems. However, since these classical techniques have linear properties, they are insufficient to overcome the non-linearity of hydraulic systems. Thus, to improve the performance, researchers have investigated different control methods for hydraulic systems.

Shol and Bobrow used a feedback linearization technique and analysed the nonlinear system equations using the derivation of a Lyapunov function to ensure stable force-trajectory tracing a hydraulic servo system [2]. Liu and Daley optimized a nonlinear PID controller designed for hydraulic systems using an estimated process model for variable process parameters [3]. Guo et.al. presented a cascade nonlinear

*Corresponding author, e-mail: aycaak@marmara.edu.tr

controller using an extended-disturbance observer to follow the chosen trajectory for electrohydraulic single-rod actuators in the existence of both parameter uncertainties and external disturbances [4]. Wang et.al. presented an adaptive nonlinear control scheme using extended state observer for motion-tracking control of a hydraulic actuator system to guess and compensate the uncertainties of the mechanical dynamics [1]. Tri et.al. used an iterative learning mechanism combined with a modified backstepping control to make adaptive tracking control of a symmetrical pump-controlled electrohydraulic actuator [5]. Alleyne et.al. Bu and Chiu have also used controllers based on the backstepping method [6, 7].

Intelligent control methods are also used to control the hydraulic systems. Deticek used a control scheme based on conventional control methods and fuzzy logic. A controller using fuzzy logic was considered as a self-learning structure that uses reinforcement learning technique to attain excellent adaptability. Further, the reference tracking was improved using an inverse-model digital force filter, and a correct final positioning was reached using a switching integrator [8]. Kalyoncu and Haydim realized positioning control of a hydraulic servo system by means of fuzzy logic control. Internal leakage is considered to get the model of the electrohydraulic servo system [9]. Çetin and Akkaya realized the hydraulic actuation system positioning control. In their study, an asymmetric hydraulic cylinder comprised applying a hybrid fuzzy-PID controller [10]. Knohl and Unbehauen developed an adaptive position controller for a hydraulic system using an artificial neural network instead of a fixed inverse nonlinearity; they further implemented an adaptive LQ controller for the system's linear part [11]. Ormandzhiev K. and Yordanov presented controller using neuro-fuzzy for electro-hydraulic tracking system has been synthesized and compared the processes with classical PD controller [12].

Several types of sliding mode control (SMC) methods have been applied to electrohydraulic control systems on [13-16]. Cerman and Hušek presented adaptive fuzzy SMC for continuous nonlinear systems with bounded disturbances and unknown dynamics. Presented method in their paper consists in adaptation of extended feedback and the switching gains of the sliding mode control parameter using the fuzzy self-tuning mechanism [17]. Guan and Pan proposed an adaptive SMC method for electrohydraulic systems with nonlinear unknown parameters [18]. Wu et al. realised fuzzy tuning on integral sliding mode controller for electro-hydraulic driving stewart set [19]. Lu et al. a used radial bases function neural network controller to compensate the errors of outer disturbances and model uncertainties of a sliding mode controller for electrohydraulic servo system [3].

Although there are many control methods for the control of hydraulic systems as seen above, the integration of artificial neural networks with Integral Fuzzy Sliding Mode control (I-FSMC) stands out as a new method. The system model considered in the present study has many nonlinear components, which increase the difficulty and complexity of the control process, including a servo hydraulic valve, a compressor and an encoder. In this study, the speed of the hydraulic system is controlled via an integral fuzzy SMC using a radial basis function neural network (RBFNN). The recommended control procedure is a computational-intelligence approach for hydraulic systems. Differently from previous studies, herein the gain of the discontinuous control of an integral sliding mode controller is adjusted using fuzzy logic and RBFNN was used for calculation of equivalent control. RBFNN's weights are set to control the system states with the purpose of reaching the sliding surface and then sliding on the surface. The model of the used hydraulic system is developed using an artificial neural network (ANN) with a time-series topology. The proposed method was compared with the PID controller whose parameters were determined by GA and PSO.

The present study is planned as follows: in Section 2, the model of a hydraulic system and the I-FSMC using a neural network are described. The simulation results for proposed hydraulic system are represented in Section 3. Conclusions of the study are given Section 4.

2. SYSTEM MODEL

The structure of the hydraulic system is given in Figure 1. The main parts are a hydraulic pump, a motor, a servo hydraulic valve and hoses. In addition, a data-acquisition card, a converter, a driver circuit and a computer are also included. So that determine the behavior of the used hydraulic system, the open loop response of the system was obtained by applying control signals with 1 volt changes between 1-10 volts.

Let the system be specified by the nonlinear discrete time difference equation given below:

$$y(t) = F[y(t - 1), \dots, y(t - n); u(t - 1), \dots, u(t - m)] \tag{1}$$

where $y(t)$ is the value of the system output at the t sample time. The F function is to define a multidimensional nonlinear system that depends on the past n system output and the past m input. n and m are positive integers. ANN output can be calculated with Equation (2)

$$\hat{y}(k) = N[y(k - 1), \dots, y(k - n); u(k - 1), \dots, u(k - m)] + e(k) \tag{2}$$

where $y(k)$ is the ANN output, N is the nonlinear definition of ANN, and $e(k)$ is the error value [20].

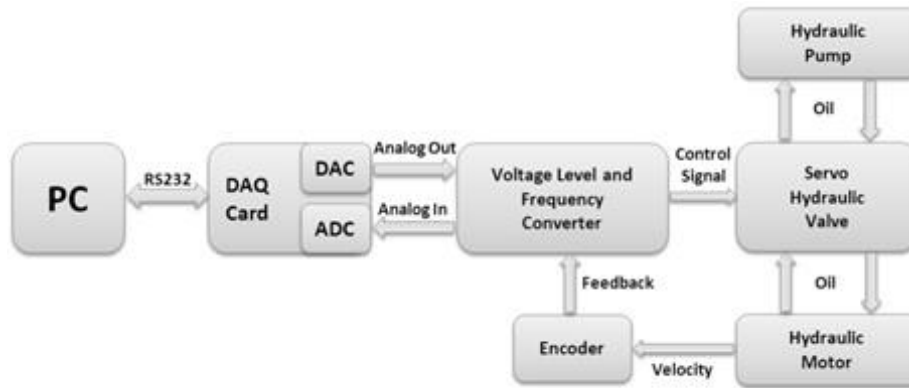

Figure 1. Hydraulic System

The block diagram of the series-parallel advanced type modeling method used in modeling the system using the Equations (1) and (2) is given in Figure 2. With the developed control software, data were collected from the system in order to train ANN. The input-output data set is generated with the data received from the system. Random control signals between 0-10 volts are applied to the system and input-output data set is formed by using the responses of the system against these control signals. 51 different values of control signals were applied to the system for 26 seconds. Seventy percent of the data in the data set was used for training the model, 15% was used to test the model and 15% was used to validation. The Levenberg–Marquardt training algorithm was used to train the ANN. Regression analysis was used to compare the system output with the model output to quantify the performance of the model [21].

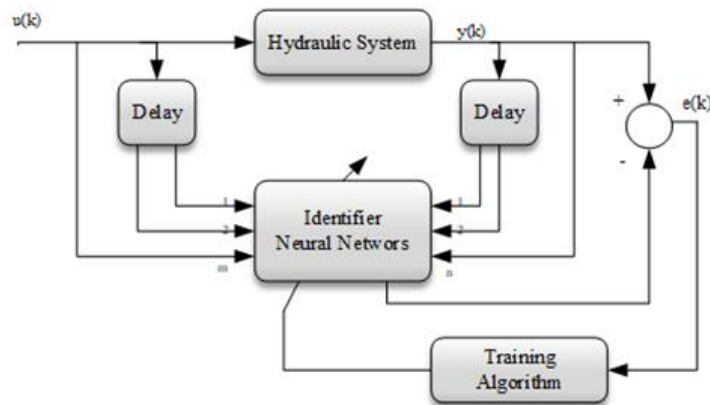

Figure 2. Series-parallel advanced type modeling

2.1 Controller Design

The form of the proposed ISMC controller is shown in Figure 3. The controller uses a linear line with an appropriate ratio between error and error difference. It includes fuzzy and neural network blocks working together. The fuzzy block determines the appropriate amplitude value, and the SMC controller switches the control signal. The equivalent control is computed using neural network block and the gain of the corrective control is calibrated using fuzzy adaptation block.

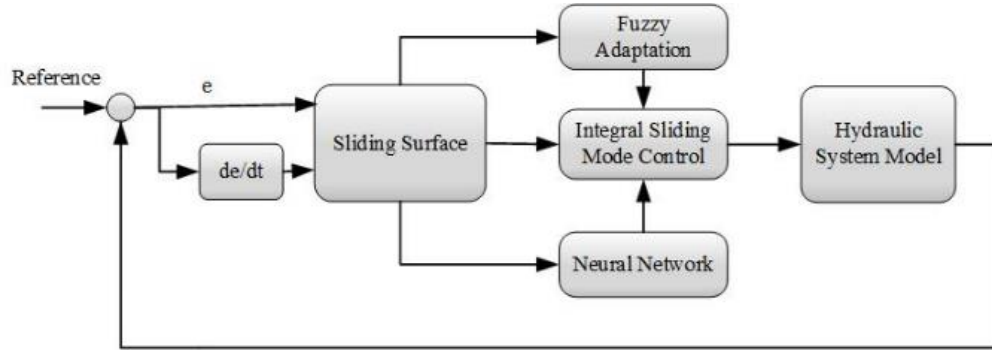

Figure 3. The Structure of the control method

2.2. Sliding Mode Control

SMC is a specific type of the variable structure systems (VSSs). SMC was first proposed in the early 1950's by Utkin and Emelyanov. SMC became more popular in the 1970's and has since been applied to nonlinear systems [22, 23].

In SMC, VSSs are considered to drive and restrain the system state to the neighborhood of switching function within the state space. The SMC design can be separated two parts. The first part is to plan of a sliding surface. The other is the designing of the control law. This control rule forces the system states onto this sliding surface in a limited time period. The surface should designate in the most appropriate way to meet all needs and all limitations. Consequently, it should be optimally designed to answer all necessities [24]. As a result, it should be designed. The trajectory of the motion from the initial condition to the sliding surface is the reaching phase. When the system state passes continuously through the switching surface, a sliding motion occurs. The equivalent control is able to preserve the system states along the sliding surface when the system state is on the sliding surface [25]. The invariance against external disturbances and parametric uncertainties is the advantage of SMC.

The classical sliding surface is expressed by the following formula [26]:

$$s(t) = \left(k + \frac{d}{dt}\right)^{n-1} e(t) \quad (3)$$

wherein k is a positive invariable and e is the error between target and actual output.

The system is not robust in the reaching phase. Therefore, system performance can be affected by the disturbances. An integral sliding mode (ISM) idea which involves the incorporation of an integral term into the sliding manifold has been developed to overcome this problem [27]. Defining the control rule as join of discontinuous and nominal control is the basic idea behind designing the ISM controller [24]:

$$s(t) = \left(k + \frac{d}{dt}\right)^{n-1} e(t) + k_i \int_0^t e(t) dt. \quad (4)$$

Control should be selected in accordance with Lyapunov criterion. For this aim, the following positive-defined Lyapunov function was selected

$$V(s) = 0.5s^T s. \quad (5)$$

The total control to be applied becomes:

$$u = u_{eq} + u_c \quad (6)$$

wherein u_e is the equivalent control part for sliding period and u_c is the corrective control part for the reaching period. The purpose of the control is to enable the trajectory to get near the sliding surface. Therefore, u_c is selected as follows:

$$u_c = K \text{sign}(s) \quad (7)$$

where K is a constant that must be positive and the discontinuous function sign is defined by following equation:

$$\text{sign}(s) = \begin{cases} -1 & s < 0 \\ 0 & s = 0 \\ +1 & s > 0 \end{cases} . \quad (8)$$

However, the determination the feedback gains for a SMC controller is difficult. In this paper, a fuzzy system is used define the gain K . High-frequency oscillations resulted from the controller in Equation (7) are defined as chattering. These undesirable oscillations may cause a high frequency response in the system. Therefore, the following function called shifted sigmoid is used in place of the sign function to remove the chattering:

$$h(s_i) = \frac{2}{1+e^{-s_i}} - 1 . \quad (9)$$

2.3. Fuzzy Integral Sliding Mode Control Using Neural Network

The fuzzy concept was foremost presented by Zadeh in 1965, and Mamdani applied the fuzzy theory to advance fuzzy logic for controlling dynamic systems [28, 29]. Since then, many researchers have developed fuzzy logic control (FLC) for several applications. In general, FLC involves a set of linguistic statements representing expert knowledge about the system, which defines a set of control actions using if-then rules. The rules in the following form are used for rule base:

IF s_i is A_i^r , THEN K_i is B_i^r ,

wherein A_i^r and B_i^r are fuzzy sets. The membership functions of s_i are NB, NM, NS, Z, PS, PM and PB (Figure 4a) and b (Figure 4b) where N, P, B, M, S and Z respectively denote negative, positive, big, medium, small and zero. The rule base is selected as in Table 1. All membership functions are in the Gaussian form:

$$\mu_A(x_i) = e^{-\left(\frac{x_i - \alpha}{s}\right)^2} . \quad (10)$$

K_i can be written as follows:

$$K_i = \frac{\sum_{r=1}^R \theta_{\lambda_i}^r \mu_{A^r}(s_i)}{\sum_{r=1}^R \mu_{A^r}(s_i)} = \theta_{ki}^T \psi \quad (11)$$

wherein R is the number of the rules, $\theta_{ki} = [\theta_{ki}^1, \dots, \theta_{ki}^r, \dots, \theta_{ki}^R]^T$ represents the centre of the membership functions of K_i and $\psi_{ki}(s) = [\psi_{ki}^1(s_i), \dots, \psi_{ki}^r(s_i), \dots, \psi_{ki}^R(s_i)]^T$ represents the height of the membership

functions of K_i in which

$$\psi_{ki}^r(s) = \frac{\mu_A(s_i)}{\sum_{r=1}^R \mu_A(s_i)} \quad (12)$$

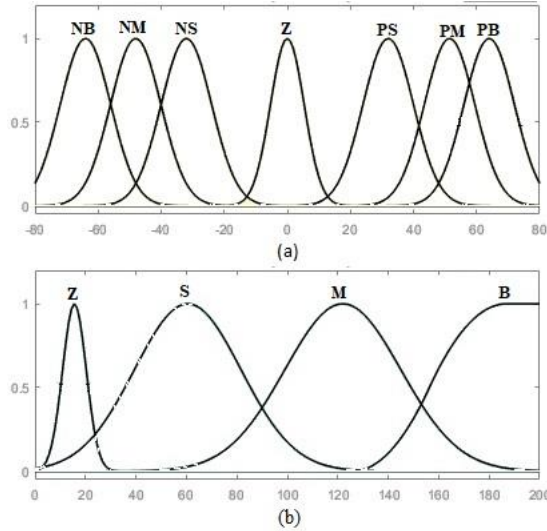

Figure 4. a) Membership functions belongs to input b) Membership functions belongs to output

Table 1. Rule base

s_i	NB	NM	NS	Z	PS	PM	PB
K_i	B	M	S	Z	S	M	B

In this study, the equivalent control is computed using RBFNN. The sliding surface (s) was used as the input to the RBFNN model. The excitation rates of the Gaussian function were the intervals between the central positions of the Gaussian functions and the sliding surface's input values [30]. The output of the RBFNN is as follows:

$$u_{eq} = \sum_{j=1}^n w_j g_j(s) = w^T g(s) \quad (13)$$

wherein j is the j th neuron of the hidden layer, g is the Gaussian function and w_j is the weighting between output and the hidden layer neurons. The intervals between the Gaussian functions central positions and the input values of the sliding surface were the excitation values of the Gaussian function [31]. The equivalent control computed using RBFNN can be expressed as following:

$$u_{eq} = \sum_{j=1}^n w_j \exp\left(-\frac{1}{2} \sum_{k=1}^N \left[\frac{s_k - c_{ik}}{\sigma_{ik}}\right]^2\right) \quad (14)$$

where c is the centre of the Gaussian function. The weightings of the network must be modified according to the reaching condition ($s\dot{s} < 0$). An adaptive rule obtained using the steep descent order was used to reduce the value of $s\dot{s}$ with respect to w_j . This adaptive rule was utilized for the purpose of finding the optimal weightings and attaining the stable convergence [32]:

$$\dot{w}_j = \gamma s(t) g(s) \quad (15)$$

wherein γ is the learning coefficient.

2.4. Determination of PID Coefficients with GA and PSO

PID parameters K_p , K_i and K_d are encoded as genes for GA. The Pittsburgh approach, which is widely used in the literature, is used as a way of learning the PID parameters of the GA method. In this approach, PID parameters are encoded within a single chromosome. The fitness function used to convert the system output to the GA fitness value is given below:

$$\phi = \frac{\sum_{k=1}^n \sqrt{(r_k - y_k)^2}}{n} \quad (16)$$

where, k is the number of samples, n is the total number of data, r is the k th reference value, and y is the k system output value.

Parameters and values used for GA can be listed as follows: population type is double vector (20); termination criterion is generation (100); limitation parameters is initial penalty (10) and penalty factor (100). The first population is randomly generated and conformity assessment is then carried out. As a result of the conformity assessment, if the appropriate values or termination criteria are reached, the values found are given to the system [20].

To reach the solution in the PSO method, each individual who will present the solution is a bird and is called a particle. Particles can be determined randomly or according to a specified criterion. The algorithm first starts with generating a group of particles. This group is called a particle swarm. The positions of the particles are determined by the two values between the individuals in each iteration. The first of these is the best value each particle has received so far, and this value is called "Pbest".

The Pbest value must be stored in memory for each particle. The second value is the best value obtained so far among all particles and this value is called "Gbest". The parameters of the PSO algorithm were determined as follows: Particle Number 40, Particle Size 3, Learning Factors 1 and Iteration Number 20 [20]

3. RESULTS

A computer model was developed for the hydraulic system to validate the efficiency of the proposed controller. A MATLAB-Simulink environment was used for this modelling. The Fuzzy Logic Toolbox of MATLAB was used for the fuzzy logic part of the control system.

Different reference inputs were applied to observe the controller behaviour for the hydraulic system. First, the system was tested by applying step inputs at different reference values (100 and 250). Figure 5 shows the simulation results when the integral fuzzy SMC controller based on RBFNN was applied.

PID controller was used to compare the I-FSMC for the hydraulic system. The parameters of the PID controller were obtained by means of a GA and PSO, as shown in Table 2 [20]. The responses obtained from the system using the PID controller with different reference values are shown in Figure 6.

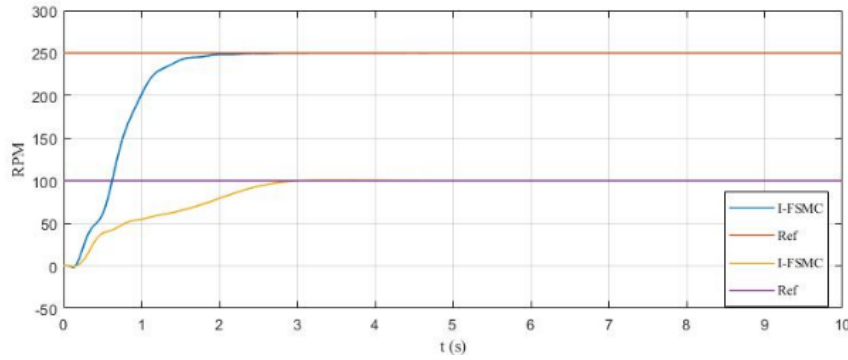

Figure 5. System response with the I-FSMC controller

Table 2. PID parameters obtained using GA and PSO

	K_P	K_I	K_D
GA	0.22732	0.025571	0.68682
PSO	0.17213	0.018225	-0.50142

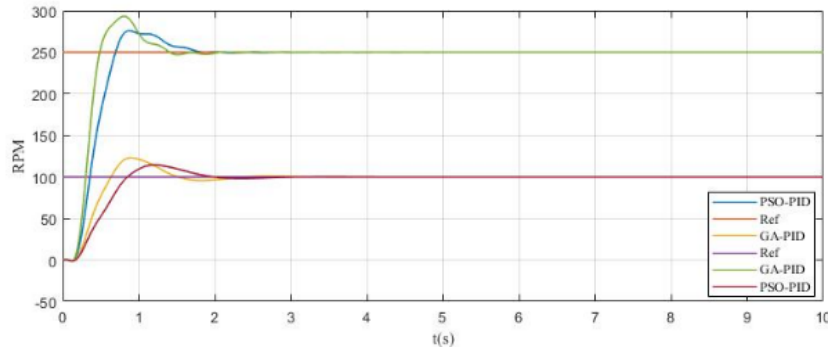

Figure 6. System response with the PID controller

Figure 7 shows the error responses for all methods. A comparison of the corresponding control actions is shown in Figure 8. The control methods are compared in Table 3. The steady-state error was 6.565×10^{-7} with the proposed I-FSMC based on the RBFNN method, -8.0257×10^{-7} in the PID with PSO and -2.0912×10^{-6} in the PID with GA. While the overshoot in the I-FSMC based on a RBFNN was 0.0674, overshoot in the PID with a PSO reached 14.4248. Conversely, the rise time was 0.9028s with the I-FSMC and 0.3433s with the PID with a GA. The peak value of the RPM was 100.825 with the I-FSMC but attained the highest value of 114.4248 with the PID with a GA.

Table 3. Comparison of control methods

Method	Rise Time	Settling Time	Overshoot	Undershoot	Peak	Steady-State Error
Integral FSMC based on RBFNN	0.9028	1.5269	0.0674	0.8250	100.825	6.565×10^{-7}
PID with PSO	0.5045	1.8414	14.4248	1.4812	114.42	-8.0257×10^{-7}
PID with GA	0.3433	2.1658	23.0064	1.7528	123.00	-2.0912×10^{-6}

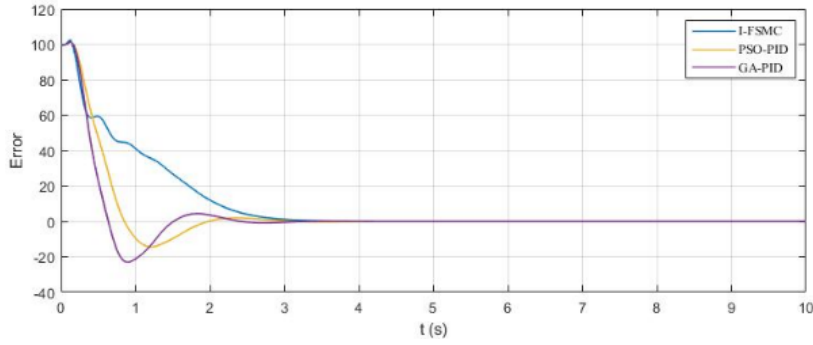

Figure 7. Error responses

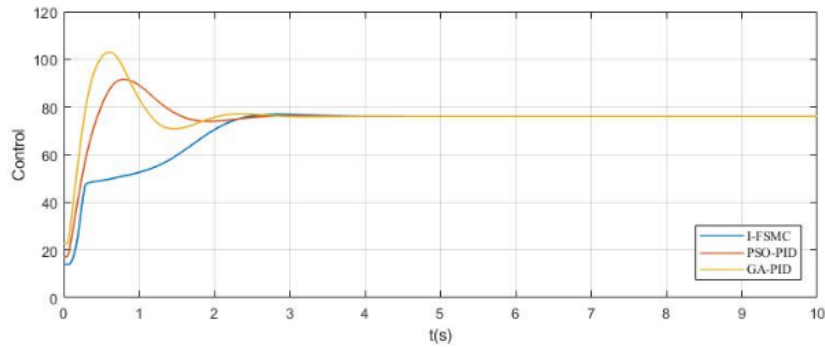

Figure 8. Control action

Secondly, the system was tested by with alternating input. Figure 9 shows the simulation results for the I-FSMC controller based on RBFNN and GA-PID and PSO-PID. Figure 10 shows the error responses for all situations.

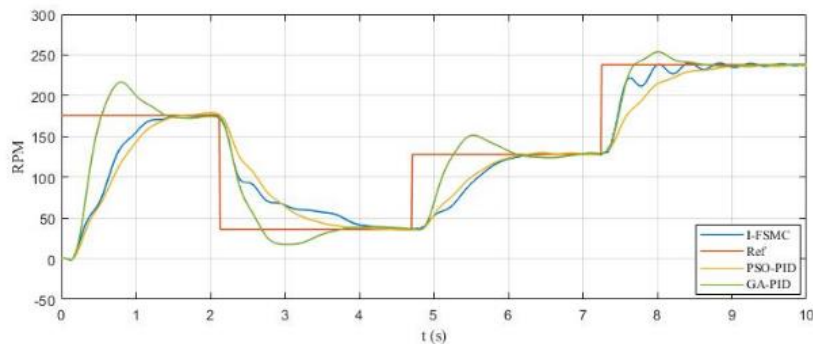

Figure 9. System response with the I-FSMC and PID controllers

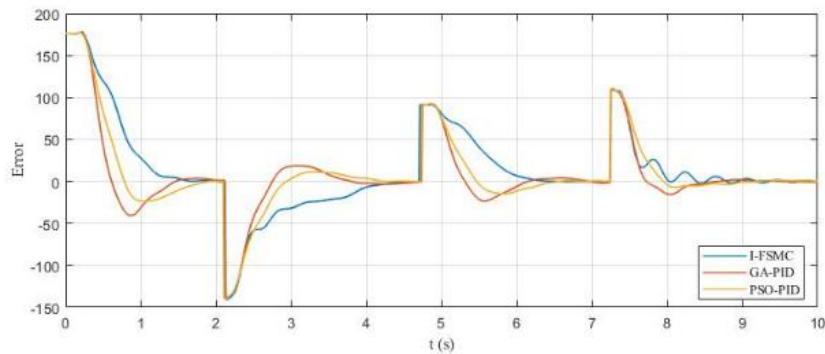

Figure 10. Error responses

When the error-time graph was examined in terms of continuous error, it was seen that the error was lower in the I-FSMC method with the exception of 8-10ms interval.

4. CONCLUSION

In this study, an integral fuzzy SMC was presented for a hydraulic system. In the conventional SMC, a larger corrective control gain may be chosen to reduce the chattering or a small corrective control gain may be chosen to increase the reaching time and tracking error. The basis of the presented control method was based on the introduction of a fuzzy self-tuning method to adapt the sliding mode switching gain. The fuzzy block generates an appropriate amplitude value by observing the online behaviour of the system.

For comparison, PID control with PSO and GA were also tested on the same system. With the proposed integral fuzzy SMC method, overshoot, settling time, steady-state error values and peak value were quite low but the rise time was larger than that PID methods. Meanwhile, the PSO used for the calculation of PID coefficients yielded better results than GA except for rise time. These simulation results show that the suggested control and adaptation methods can provide good performance in hydraulic systems.

CONFLICTS OF INTEREST

No conflict of interest was declared by the authors.

REFERENCES

- [1] Wang, C., Quan, L., Jiao, Z., Zhang, S., “Nonlinear Adaptive Control of Hydraulic System with Observing and Compensating Mismatching Uncertainties”, *IEEE Transactions on Control Systems Technology*, 26(3): 1-12, (2017).
- [2] Shol, G. A., Bobrow, J. E., “Experimental and simulations on the nonlinear control of a hydraulic servo system”, *IEEE Transactions on Control Systems Technology*, 7(1): 238–247, (1999).
- [3] Liu, G. P., Daley, G. P., “Optimal-tuning nonlinear PID control of hydraulic systems”, *Control Engineering Practice*, 8(9): 1045–1053, (2000).
- [4] Guo, K., Wei, J., Fang, J., Wang, X., “Position tracking control of electro-hydraulic single-rod actuator based on an extended disturbance observer”, *Mechatronics*, 27: 47-56, (2015). DOI: 10.1016/j.mechatronics.2015.02.003
- [5] Tri, N. M., Nam, D. N. C., Park, H.G., Ahn, K. K., “Trajectory control of an electro hydraulic actuator using an iterative backstepping control scheme”, *IEEE Transactions on Control Systems Technology*, *Mechatronics*, 29: 96–102, (2015).
- [6] Alleyne, A., Liu, R., “A simplified approach to force control for electrohydraulic systems”, *Control Engineering Practice*, 8(12): 1347–1356, (2000). DOI: 10.1016/S0967-0661(00)00081-2
- [7] Yao, B., Bu, F., Chiu, G. T. C., “Nonlinear adaptive robust control of electrohydraulic servo systems with discontinuous projections”, *Proceedings of the IEEE Conference on Decision and Control*, Tampa (USA), 2: 2265–2270, (1998).
- [8] Deticek, E., “A fuzzy self learning position control of hydraulic drive”, *Cybernetic Systems*, 31 (8): 821–836, (2000). DOI: /10.1080/019697200750038959
- [9] Kalyoncu, M., Haydim, M., “Mathematical modelling and fuzzy logic based position control of an electrohydraulic servo system with internal leakage”, *Mechatronics*, 19(6): 847–858, (2009). DOI: <https://doi.org/10.1016/j.mechatronics.2009.04.010>

- [10] Çetin, Ş., Akkaya, A. V., “Simulation and hybrid fuzzy-PID control for positioning of a hydraulic system”, *Nonlinear Dynamics*, 61: 465–476, (2010).
- [11] Knohl, T., Unbehauen H., “Adaptive position control of electrohydraulic servo systems using ANN”, *Mechatronics*, 10(1-2): 127–143, (2000).
- [12] Hasanifard, G., Zarif, M.H., Ghareveisi, A.A., “Nonlinear Robust Backstepping Control of an Electrohydraulic Velocity Servosystem”, *Mediterranean Conference on Control and Automation*, 27-29, (2007).
- [13] Bonchis, A., Corke, P. I., Rye D. C., Ha Q. P., “Variable structure methods in hydraulic servo systems control”, *Automatica*, 37(4): 589–595, (2001). DOI: 10.1007/s11771-008-0048-1
- [14] Liu, Y., Handroos, H., “Technical note sliding mode control for a class of hydraulic position servo”, *Mechatronics*, 9(1): 111–123, (1999).
- [15] Yang, L., Yang, S., Burton, R., “Modelling and robust discrete-time sliding-mode control design for a fluid power electrohydraulic actuator (EHA) system”, *IEEE/ASME Transaction Mechatronics*, 18(1): 1–10, (2013).
- [16] Tang, R., Zhang, Q., “Dynamic sliding mode control scheme for electro-hydraulic position servo system”, *Procedia Engineering*, 24: 28–32, (2011). DOI: 10.1016/j.proeng.2011.11.2596
- [17] Cerman, O., Petr, H., “Adaptive fuzzy sliding mode control for electro-hydraulic servo mechanism”, *Expert Systems with Applications*, 39(11): 10269–10277, (2012).
- [18] Guan, C., Pan, S., “Adaptive sliding mode control of electro-hydraulic system with nonlinear unknown parameters”, *Elsevier Control Engineering Practice*, 16(11): 1275–1284, (2008).
- [19] Wu, B., Dong, Y., Wu, S., Xu, D., Keding, Z., “An Integral Variable Structure Controller with Fuzzy Tuning Design for Electro-hydraulic Stewart Platform”, *1st International Symposium on Systems and Control in Aerospace and Astronautics*, Harbin (China), 941-945, DOI: 10.1109/ISSCAA.2006.1627480 (2006).
- [20] Yılmaz, E., “Modelling a Hydraulic System Using Artificial Neural Networks and Controlling with PID Algorithm Coefficients Optimized by Genetic and Particle Swarm Algorithms”, *Master Thesis, Marmara University Institute of Science and Technology, Istanbul*, 27-28, (2012).
- [21] Yılmaz, E., Topuz, V., Baba, A.F., “Modeling of a Hydraulic System with ANN and Control with GA-PID and PSO-PID”, *Automatic Control National Meeting*, Malatya, 842-847, (2013).
- [22] Utkin, V. I., “Variable Structure Systems with Sliding Modes”, *IEEE Transaction on Automatic Control*, 22(2): 212-222, (1977).
- [23] Edwards, C., Spurgeon, K., *Sliding Mode Control*, First Edition, Taylor&Fransis Ltd., London, (1998).
- [24] Bandyopadhyay, B., Kim, K., Deepak, F., *Sliding Mode Control Using Novel Sliding Surfaces*, First Edition, Springer-Verlag Berlin Heidelberg, Switzerland, (2009).
- [25] Tsai, C., Chung, H., Yu, F., “Neuro-Sliding Mode Control with Its Applications to Seesaw Systems”, *IEEE Transaction on Neural Networks*, 15(1): 124-134, (2004).

- [26] Kalayci, M.İ., Yiğit, İ., “Theoretical and Experimental Investigation of Some Sliding Mode Control Techniques Used in Practice”, *Journal of the Faculty of Engineering and Architecture of Gazi University*, 3(1): 131–142, (2015).
- [27] Utkin, V.I., Shi, J., “Integral sliding mode in systems operating under uncertainty conditions”, *Proceedings of the 35th Conference on Decision and Control, Kobe (Japan)*, 4591–4596, (1996).
- [28] Zadeh, L. A., “Outline of a new approach to the analysis of complex systems and decision processes”, *IEEE Transaction System Man Cybernetics*, 3(1): 28–44, (1973).
- [29] Mamdani, E.H., Assilian, S., “An experiment in linguistic synthesis with a fuzzy logic controller”, *International Journal of Man-Machine Studies*, 7(1): 1-13, (1975).
- [30] Huang, S., Huang, K., Chiou, K., “Development and Application of a Novel Radial Basis Function Sliding Mode Controller”, *Mechatronics*, 13(4): 313–329, (2001).
- [31] Azeem, M.F., Hanmandlu, M., Ahmad, N., “Generalization of Adaptive Neuro-Fuzzy Inference Systems”, *IEEE Transaction on Neural Networks*, 11(6): 1332–1346, (2000).
- [32] Ak, A., Cansever, G., Delibaşı, A., “Robot Trajectory Tracking with Adaptive RBFNN Based Fuzzy Sliding Mode Control”, *Information Technology and Control*, 40(2): 151–156, (2011). DOI: <http://dx.doi.org/10.5755/j01.itc.40.2.430>