

Application of rotational accelerometers on the measurement of automotive headlamp cut-off deviation

Barış Ediz^{1*}, Erhan Ay¹, Emre Öztürk¹

¹Marelli Mako Turkey Elektrik Sanayi ve Ticaret A.Ş., Turkey

Orcid: B. Ediz (0000-0002-2704-7090), E. Ay (0000-0001-9621-6030), E. Öztürk (0000-0001-5492-9358)

Abstract : Automotive lighting products, such as Head Lamps (HL), Fog Lamps (FL), Daytime Running Lamps (DRL), face with mechanical vibrations during service life which may coincide with the resonance frequencies of the light source. When excited at resonance frequencies, especially in the case of HL's, light beam cut-offline may deteriorate and vibration of light beam occurs. This situation is also called light flickering. This state has disturbing effect on the driver's visibility, which is valid for both the driver and the counter drivers. Most of the automotive manufacturers have developed test specifications for evaluation of flickering state under sinusoidal frequency sweep acceleration loading and they have introduced limits for flickering angle range or displacement range of the light beam with respect to frequency measured on a screen which is put on a prescribed distance from the light source. In this study a traditional way of light beam flickering angle deviation measurement method of HL is presented. Furthermore, application of precise & efficient way of measurement method by the use of quartz rotational accelerometer is inspected.

Keywords: Head Lamp, Light Beam Vibrations, Light Flickering, Quartz Rotational Accelerometer, Sinusoidal Sweep Test, Resonance Search Test, Harmonic Sweep

1. Introduction

Due to vibrations coming from the road conditions at low frequencies between 10Hz to 50Hz, automotive headlamps must be designed to avoid resonance frequencies below 50Hz or response of the HL to low frequency vibration excitations must be significantly low. Light source excited by vibration loads at its resonance frequencies starts to vibrate and this will cause light beam vibrations which is also called light flickering. Light flickering has disturbing effect to the light pattern in front of the car and to the visibility of the both driver & counter drivers. In order to prevent the disturbing situation, car & HL manufacturers have developed test specifications and test methods for measuring HL light beam vibration range.

In this paper the traditional reflected laser beam displacement measurement method and application of quartz rotational accelerometer on direct measurement of the rotational accelerations has been discussed. Reflected laser beam method requires lots of effort from preparation of test set-up to conduction of measurements. Furthermore, this method has low accuracy level due to manual work of the technician and requires further calculations based on assumptions. In contrast, application of new measure-

ment device, quartz rotational accelerometer, has been introduced for HL beam vibration direct measurements. Furthermore, rotation angle range is calculated from conversion of rotation angle acceleration frequency response to rotation angle frequency response by multiplying the double amplitude of the rotational acceleration by the square of the frequency. Rotational accelerometer reduces the effort required to perform tests and increases the accuracy level of the measurements.

In the literature one can find several studies related to different application areas of rotational accelerometers as a measurement equipment for different aims.

Methods for measuring rotational motion and linear motion of a vehicle has been proposed by using five different configurations of linear accelerometers [1]. Increase in measurement errors by the use of linear accelerometers to measure rotational motion has been mentioned. Direct angular acceleration measurement device which is mostly used to calculate the rotational inertia of the crash test dummies, quartz rotational accelerometer, has been introduced. This type of accelerometer also has been used to measure vibration shaker head rotations, which

* Corresponding author.
Email: baris.ediz@marelli.com



has significant effect on the accuracy of the modal tests [2]. Performance capabilities of commercially available direct rotational accelerometers for identification of rotational DoFs in the field of structural dynamics has been inspected. Advantages & disadvantages of using quartz rotational accelerometer as direct measuring device have been presented. [3]. A method for measuring high quality torsional receptance by the use of quartz rotational accelerometer has been presented. This method has been used to measure torsional receptance's at the ends of a shafting system and good estimations have been made [4]. In order to diminish the effects of rotational shocks and vibrations from a small disk drive, an algorithm which uses signal from a rotational accelerometer has been introduced [5]. A MEMS-based rotational accelerometer has been successfully applied to the rejection of rotational disturbances on a commercial computer hard disk drive (HDD) [6]. HL beam displacements has been measured under sinusoidal harmonic excitation on a vibration shaker by laser method and results are compared with harmonic FEA results. [7]

2. Material & Methods

2.1. Sinusoidal Sweep Excitation

The force contains one single frequency at a time and the excitation sweeps from one frequency to another with a given step, allowing the structure to engage in one harmonic vibration at a time. [8]

In this study, constant 1g sinusoidal base excitation acceleration load is applied by the vibration shaker over the frequency range. Unit constant acceleration is used as excitation and frequency response of the system is measured. Frequency sweep rate kept constant as 1 octave/minutes between 10 Hz to 100Hz.

Test set-up for sinusoidal sweep excitation is given in Figure 1.

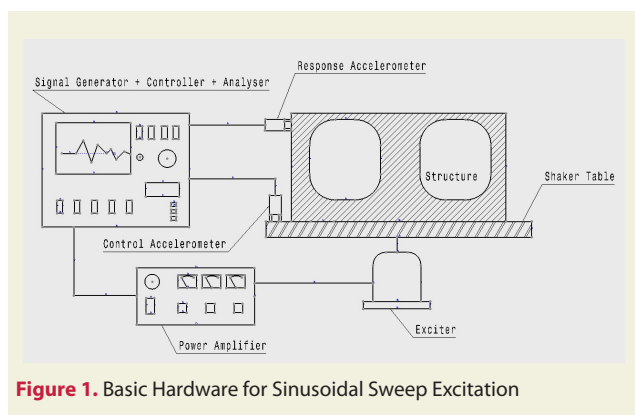

Figure 1. Basic Hardware for Sinusoidal Sweep Excitation

Harmonic response of displacement $x(t)$ for a single-degree-of-system excited by an harmonic Force, $F(t) = kA\cos\omega t$, is given by the equation below [9];

$$x(t) = A|G(i\omega)|e^{i(\omega t - \phi)} \tag{1}$$

where $G(i\omega)$ is a measure of the system response to a har-

monic excitation of frequency ω .

When equation (1) is differentiated with respect to time;

$$\dot{x}(t) = i\omega A|G(i\omega)|e^{i(\omega t - \phi)} = i\omega x(t) \tag{2}$$

$$\ddot{x}(t) = (i\omega)^2 A|G(i\omega)|e^{i(\omega t - \phi)} = -\omega^2 x(t) \tag{3}$$

After inspecting the equations (2) and (3), it is concluded that the magnitude of the velocity is equal to the magnitude of the displacement multiplied by the factor ω and magnitude of the acceleration is equal to the magnitude of the displacement multiplied by the factor ω^2 .

2.2. Laser Beam Reflection Method

In order to measure light beam vibrations, a traditional method is used. Similar test methods to this one has been performed by HL manufacturers as component level verification methods. Acceptance criteria, upper & lower response limits and some test parameters like screen distance D (mm), excitation g level, test frequency range etc.; are propriety information depending of HL & Car manufacturers. This method is based on measuring the light beam deflection on a screen with respect to frequency of the constant sinusoidal base excitation acceleration load applied on HL placed on a fixture on the vibration shaker (Figure 2 & Figure 3). A laser beam is projected to the mirror placed in front of the light source of HL and the laser beam is reflected to a screen placed on a prescribed distance D from the light source (Figure 2 and Figure 3). Technician marks the upper & lower ends of the reflected beam pattern on the millimetric paper for each excitation frequency intervals. Afterwards, vertical displacement range $d(\omega)$ of the light beam at the corresponding excitation frequencies are measured. (Figure 3.b). As a result, rotation angle frequency response $R(\omega)$ range in degrees, can be calculated by the given formula below;

$$R(\omega) \cong 0,5 \tan^{-1} \frac{d(\omega)}{D} \tag{4}$$

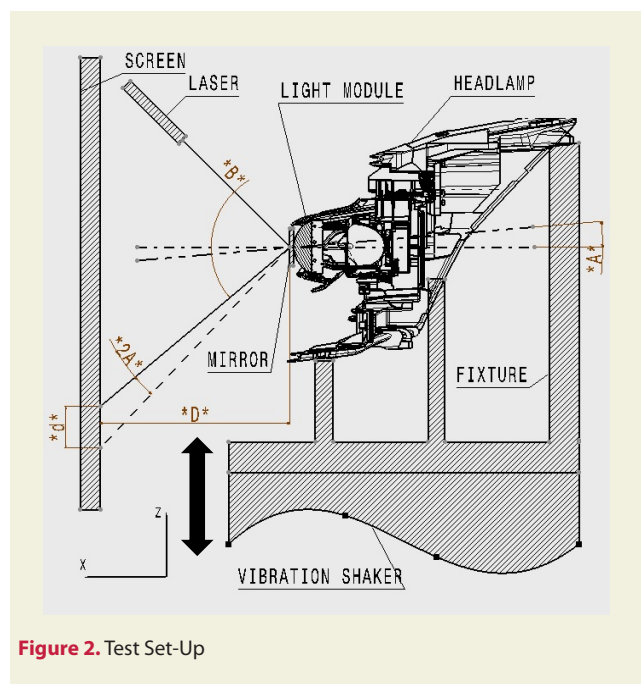

Figure 2. Test Set-Up

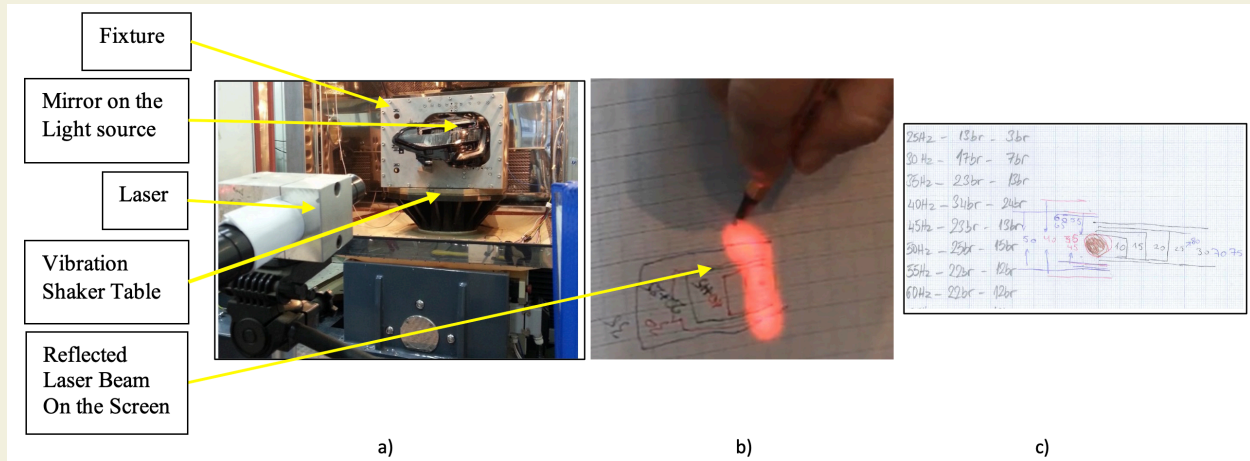

Figure 3. a) Laser beam pointed to mirror on the light source, b) Example of marking of light beam displacement range reflected on a millimetric paper placed on a screen prescribed distance D to light source c) Displacement Ranges after completion of test

where $d(\omega)$ is the vertical displacement range of the projected laser beam on the screen in mm and D is the horizontal distance between the HL light source and the screen in mm.

Graphical representation of light beam calculated rotation angle range in lateral y -axis with respect to frequency is made and compared with the limits (Figure 4).

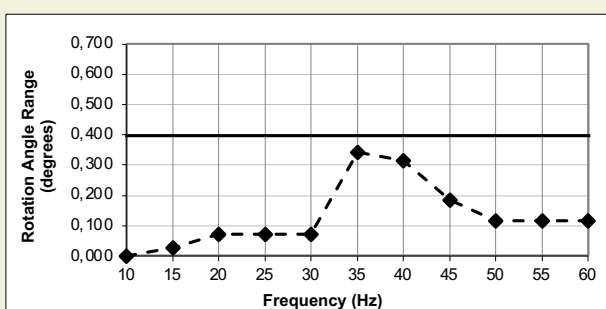

Figure 4. Example of measurement result (---) with respect to limits (—) for rotation angle range of light beam

2.3. Application of Rotational Accelerometer

In order to measure oscillations occurring about the lateral y -axis of the light source with respect to frequency, KIS-

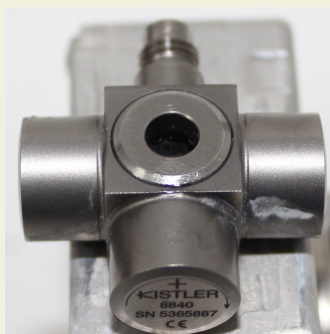

Figure 5. KISTLER® shear-quartz type 8840 rotational accelerometer

TLER® shear-quartz type 8840 rotational accelerometer has been used.(Figure 5)

Rotational accelerometer is placed on the rear side of the light module in such a way that it can measure lateral oscillations. (Figure 6)



Figure 6. Rotational accelerometer placed on the rear side of light module

The element structure of Type 8840 accelerometer is such that the unit will accurately measure the acceleration magnitude of oscillations laterally induced to its mounting base. Technical characteristics of the accelerometer is given in Table 1.

Output of the accelerometer is connected to vibration shakers data acquisition unit and sinusoidal sweep excitation under 1g constant acceleration has been performed between 10Hz – 100 Hz with frequency sweep rate of 1 octave/minute. Rotation angle acceleration frequency response of the accelerometer has been tabulated and plotted by the help of shakers digital signal processing (DSP) and synthesis software. Furthermore, amplitude of rotation angle acceleration has been converted to rotation angle amplitude by the analogy of equation (3). However this time, acceleration frequency response is the rotation angle acceleration frequency response in degrees/s², displacement frequency response is rotation angle frequency response in degrees

Table 1. Technical data for Type 8840 rotational accelerometer

Specification	Unit	Type 8840
Acceleration range	krad/s ²	±150
Acceleration limit	krad/s ²	±200
Threshold (noise 130 μVrms)	rad/s ²	4
Sensitivity nom.	μV/rad/s ²	35
Resonant frequency mounted, nom.	kHz	23
Frequency response, ±10%	Hz	1 ... 2000
Amplitude non-linearity	%FSO	1
Time constant	s	1
Transverse sensitivity typ (max.)	%	1.5 (2)
Vibration (max.)	g	2000
Shock limit (1 ms pulse width) max.	g	5000
Base strain sensitivity @250με	g με	0.005
Long term stability	%	±1
Temperature coefficient of sensitivity	%/°F	-0.03
Temperature range operating	°F	-65 ... 250
Temperature range storage	°F	-100 ... 300

$$|Rotation\ angle\ (\omega)| = \frac{|Rotation\ Angle\ Acceleration(\omega)|}{\omega^2} \tag{5}$$

3. Results & Discussion

Measurement results of laser beam reflection method and measurement results of rotational accelerometer are plotted back to back on Figure 7. Rotational accelerometer predicts the resonance frequency at 48.42Hz with double amplitude of 0.47°. However, laser beam reflection method predicts the resonance frequency at 45Hz with the double amplitude of 0.46°. Which means, 7.1% error in frequency and 2.1% error in double amplitude.

When Figure 7 is inspected in detail; it is obvious that due to low resolution of laser beam measurement method, in which the data is taken at 5Hz intervals, behaviour of the system can not be characterised in detail and some peaks and features are missed. Due to higher frequency resolution of rotational accelerometer measurements, rotation angle frequency response of the system can be characterised in more detail.

Sinusoidal sweeps have been performed by constant 1g vertical excitation with 1 octave/minute sweep rate on the shaker with & without rotational accelerometer mounted on the light module in order to understand the effect of 18.5gr weight of the rotational accelerometer on the resonance frequency of the light module. Another acceler-

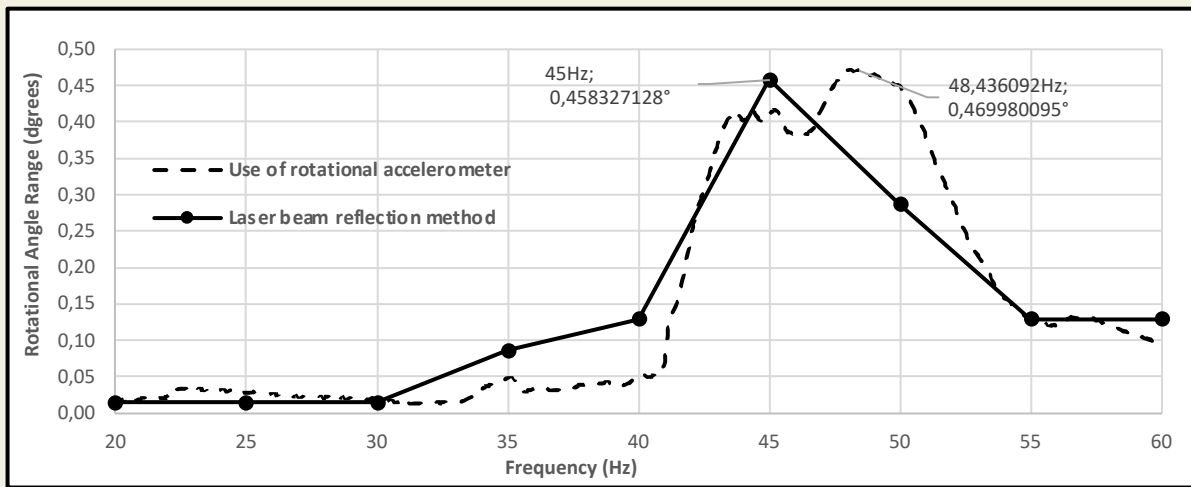

Figure 7. Comparison of resonance search results, laser beam reflection method vs the use of rotational accelerometer

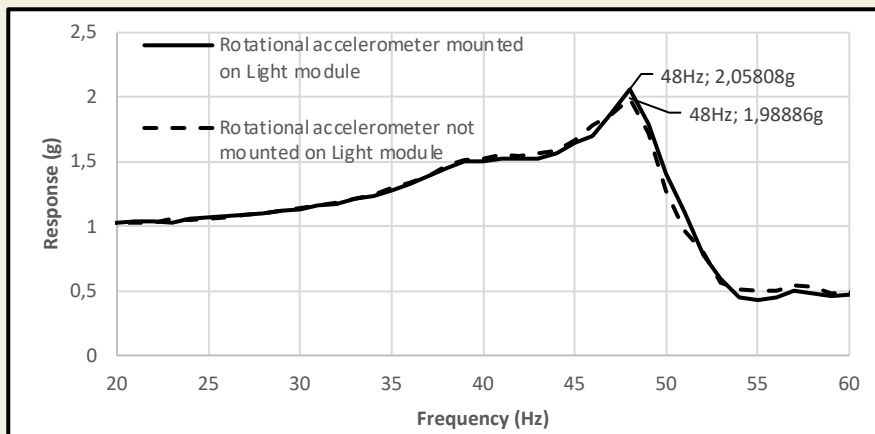

Figure 8. Effect of Rotational Accelerometer Weight on Resonance Frequency

ometer has been mounted on the housing of the HL and vertical acceleration frequency response of the HL has been measured. Frequency response curves with 1Hz resolution has been plotted on Figure 8 below.

When Figure 8 is inspected in detail; it is obvious that 18.5gr weight of the rotational accelerometer does not effect the resonance frequency of the light module significantly when 1Hz resolution is taken into account.

4. Conclusion

In this study, traditional laser beam reflection method & a new method which uses a quartz rotational accelerometer for measuring HL light beam vibrations are inspected and compared. According to this study below conclusions can be made:

- Laser beam reflection method needs many efforts from preparation of test set-up to preparation of test sample. However, application of rotational accelerometer reduces the effort and time for test set-up preparation and for preparation of test sample.
- Laser beam reflection method has low accuracy level due to manual work of the technician, open to errors. However, application of rotational accelerometer prevents manual work and prevents errors.
- Results of laser beam reflection method cannot characterize the system rotation angle frequency response in detail due to data taken at 5Hz intervals which gives low resolution frequency response curve. However, by the application of rotational accelerometer, usage of signal acquisition hardware and DSP software, high resolution rotation angle frequency response curves can be plotted. In this way, system rotation angle frequency response can be characterized in detail.

There are other techniques used in determination of modal parameters and structural characteristics. One of them is called laser Doppler Vibrometry. This technique uses laser beams & the principle of interferometry. Dynamic structural characteristics and modal parameters are measured without mounting any sensor on the test sample. Hence, in this way, test sample is not affected by the weight of the sensor. However, this innovative technique requires more expensive equipment than the method proposed in this paper. Future work on this subject can be the investigation of Automotive HL light beam vibrations by Laser Doppler Vibrometry.

5. References

- [1] Schuler, A.R., Grammatikos, A., Fegley, K. A., (1967). Measuring Rotational Motion with Linear Accelerometers. *IEEE Transactions on Aerospace and Electronic Systems*, 3: 465-472. doi: 10.1109/TAES.1967.5408811.
- [2] Dumont, M., Kinsley, N., (2015). Rotational Accelerometers and Their Usage in Investigating Shaker Head Rotations. *Sensors and Instrumentation. Conference Proceedings of the Society for Experimental Mechanics Series*, 85-92. doi:10.1007/978-3-319-15212-7_10.
- [3] Drozg, A., Rogelj, J., Čepon, G., Boltežar, M., (2018). On the performance of direct piezoelectric rotational accelerometers in experimental structural dynamics. *Measurement*, 127: 292-298. doi:10.1016/j.measurement.2018.05.081.
- [4] Tsai, S. H., Ouyang, H., Chang, J. Y., (2019). Identification of torsional receptances. *Mechanical Systems and Signal Processing*, 126:116-136. doi:10.1016/j.jymssp.2019.01.050.
- [5] Abramovitch, D. Y., (1997). Rejecting rotational disturbances on small disk drives using rotational accelerometers. *Control Engineering Practice*, 5(11): 1517-1524. doi:10.1016/S0967-0661(97)10005-3.
- [6] Oboe, R., Vigna, B., Gola, A., (2000). Application of MEMS-based rotational accelerometers to vibration suppression in hard disk drives. *2000 Asia-Pacific Magnetic Recording Conference, Digests of APMRC2000 on Mechanical and Manufacturing Aspects of HDD, MP17/1-MP17/2*. doi: 10.1109/APMRC.2000.898952.
- [7] Roucoules, C., Chemin, F., Cros, C., (2010). FRF prediction and durability of optical module and headlamp. *Proceedings of ISMA2010 including USD2010*, 1: 4373-4383.
- [8] He, J. , Fu, Z.F, (2001). *Modal Analysis*. Butterworth – Heinemann, Linacre House, Jordan Hill, Oxford OX2 8DP 225 Wildwood Avenue, Woburn, MA 01801-2041.
- [9] Meirovitch, L., (2001). *Fundamentals of Vibrations*. McGraw-Hill, Boston.