



The Examination of the Performance Factors on NG-DWDM Systems with Roadm Structure

Yusuf ÖZDUMAN¹, Murat YÜCEL^{2, *}

¹*Turk Telekom Head Office Network Department, Ankara, Turkey*

²*Department of Electric-Electronic Engineering, Faculty of Technology, Gazi University, Ankara-Turkey,*

Received: 28/09/2015 Revised: 29/12/2015 Accepted: 28/02/2016

ABSTRACT

Nowadays, the new technologies provide high capacity by using 100 Gb/s channels. These systems are useful, practical, and flexible by using Optical Transport Networks (OTN) and Reconfigurable Optical Add Drop Multiplexers (ROADMs) structures. These new features supply new protection mechanisms over switching on Wavelength Selective Switching (WSS) layer, and Automatically Switching Optical Network (ASON) that is the Generalized Multiprotocol Label Switching (GMPLS) based software runs on the Dense Wavelength Division Multiplexing (DWDM) network elements. In this paper, effects of the optical signal-to-noise ratio (OSNR) are analyzed by increasing the channel lengths on a real long-haul ROADM DWDM network. Then, new cases on channel balancing comes with ROADMs are discoursed. In addition, protection mechanisms are represented and compared by the test results.

Key Words: *ROADMs, DWDM, OTN, WSS, OSNR, ASON, protection, performance.*

1. INTRODUCTION

The fiber optical communication traffic has been increasing exponentially and becoming more dynamic due to the advancing applications such as quality video

on demand, inter-datacenter networking, IPTV, online gaming that requires high speed, and e-science/e-school/e-government applications. These growth leads

*Corresponding author, e-mail: muyucel@gazi.edu.tr

to increasing demands for better efficiency with respect to resources, scale, energy, and cost. To meet these demands, recent innovations in transmission systems have led to increasing line rates of wavelength division multiplexing (WDM) channels from 10 to 40 to 100 Gb/s.

A typical system uses 40 channels at 100 GHz spacing however if there were more channels, the spacing between adjacent DWDM channels could be reduced from 100 to 50 GHz or narrower, and thus utilization of spectral resources could be increased. To increase the utilization of wavelength resources, mixed line rate systems can be deployed to accommodate heterogeneous traffic types at different data rates. Thus, DWDM technologies take part on most core network of the main telecommunication operators. In able to transmit the huge data traffics, there is a need of multiplexing the signals through the optical fiber [1-6].

DWDM technologies are an inevitable constituent of long-haul communication systems. Formerly, it was used between big cities. Today, DWDM is being used inside the cities, to towns, to big customers etc. The increased number of end users and bit rate request of each user, directed vendors to put more channel on the optical signal [7] and increase the bit rate of each channel [8]. By using OTN [9] frame structure, almost all kind of services can be multiplexed in to the optical channels.

New technologies also provide more flexibility to DWDMs. ROADM is the key parameter building dynamically reconfigurable DWDM network. ROADM structure provides ability to add/drop optical channels between sites [10-11]. With the new structures and higher bit rates, there are much more issues for the operators to pay attention about services working over DWDM systems [12].

40G and 100G optical channel bit rate are widely being used in telecommunication networks. Dual Polarization-Quadrature Phase Shift Keying (DP-QPSK) modulation technique gives efficient result for 100G. Because using more bandwidth with higher channel bit rates in 100G channels, we need better Optical Signal to Noise Ratio (OSNR) for the same Bit error rate (BER) [13].

By using coherent detectors in the receiver Optical Transponder Unit (OTU), which modulates and demodulates signal, requirement for compensation of chromatic dispersion is eliminated but OSNR is the major performance factor for the 100G channels [14]. Polarization Mode Dispersion (PMD) value of the fiber also becomes an important parameter due to dual polarized modulation used for 100G channels on DWDM links [15].

40G and 100G channels need better OSNR for error-free transmission. ROADM structure enables add-drop channels in every site so channel power balance and appropriate sum power becomes very important. We have to concern each channel end to end, each optical amplifier work correctly depending on the sum power, and link power balance to avoid interference. Vendors do have some planning tools, some functions on Network Management Systems (NMSs) for these issues, but in each case there is a need of precision at least for troubleshooting.

New technologies have also improved protection mechanisms on DWDM systems. WSS boards and automatically tunable OTU boards enable directionless and colorless mechanisms. ASON using GMPLS based software enables these protection mechanisms to be run on DWDM equipment but unlike electrically protection switching, test results show switching durations can be much more than 50 ms. By embedding cross-connection boards between client signal and OTUs, electrical protection is also applicable for service protection on NG-DWDM systems. By use of simple optical filter boards on the receiver sites, traditional and Traditional + ASON mixed protections can be applied.

In this paper, important performance factors of NG-DWDM (Next generation Dense Wavelength Division Multiplexing) are examined. In Section 2, OSNR effect on 100G and new protection mechanisms are represented and compared based on the test results. Then new issues about channel balancing on DWDM links that come with ROADM is shown.

2. THE ANALYSES OF THE OSNR EFFECTS

OSNR performances and protection mechanism in the DWDM systems using the long haul fiber optic links are analyzed. Firstly, we examined 100G configurations with regeneration shown in Fig. 1. It is a real DWDM network already working with 40G channels, and has active traffic being in the channels. ROADM sites that are able to add/drop traffics are used in the cities including basically multiplexers, WSS layer boards and the boosters to amplify transmitted and received line signals. Optical line amplifiers (OLA) are established only to amplify the optical signal on both directions. In this network, 12 ROADM/DWDM, 2 OLA that are erbium doped fiber amplifier (EDFA) are used and regeneration is applied. The test result was successful, the BER testers in the A and Z that are connected to the client port of the 100G transponders, are working with no errors. Then, the same route is tested without regeneration; the test result was successful again, which means successful 100Gb/s channel transmission for 565 km distance.

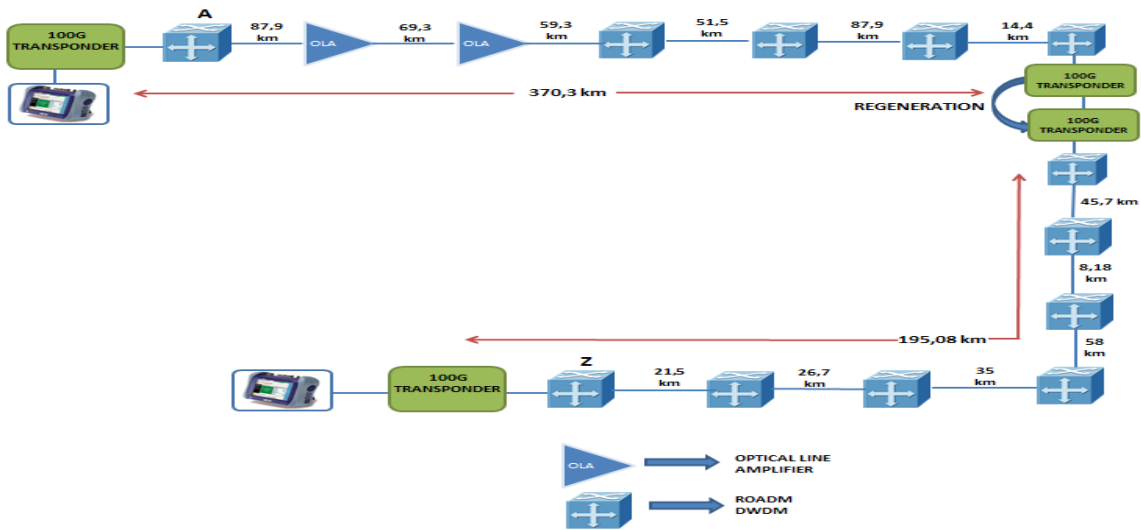

Figure 1. 100G-performance test configuration

Secondly, we tried the test on the network shown in Fig. 2. In this network, 19 ROADM/DWDM and 11 OLA that includes erbium doped fiber amplifier (EDFA) are used. Total distance of line is 1556.3 km without any regeneration. The test results were unsuccessful because of low OSNR [16].

OSNR decreases from beginning of the channel to the

end, and there is a threshold minimum value of that, for error-free transmission. This minimum threshold value depends on multiple factors [17]; dispersion, non-linear effects in the fiber optic cable, laser wavelength, optical amplifier types [18], coding and modulation methods [19], forward error correction (FEC) algorithm [20], receiver complexity etc. Generally, it is not less than 10 dB.

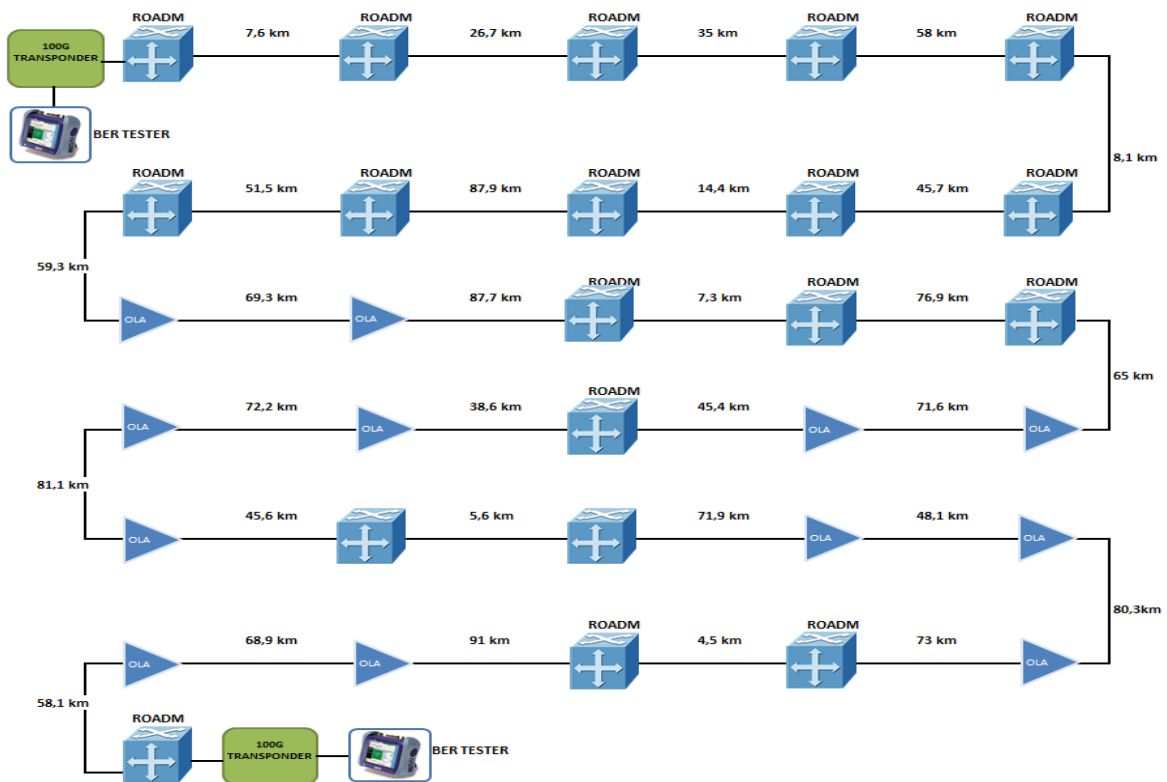

Figure 2. Second 100G test configuration (resulted unsuccessfully)

When the optical channel (Och) is created, the attenuation value to that channel decreases from maximum to a normal value (such as -15 dB to -5 dB) on WSS boards, which lets the channel to pass through.

The noise power increases too much because of the channel route passes through a lot of amplifiers, and has a power value close to the power of signal on that frequency. So, in this case the OSNR value is too low and the test was unsuccessful. We tried 195.7 THz and 195.9 THz channels and saw the same results.

The received signal spectrum on site Z while A site transponder signal is on and off mode shown in Fig.3

and Fig. 4, respectively. The spectrums show that the noise power is close to signal power. The channel frequency is 195.7 THz which corresponds to 1531.9 nm wavelength. From the first spectrum signal + noise on that channel is measured as -20.56 dBm and from the second spectrum by closing the transponder laser on the opposite site, that makes the signal off for corresponding wavelength channel, noise figure power on that channel is measured as -23.01 dBm. OSNR value can be calculated by subtracting these values. OSNR value is 2.45 dB that makes the channel does not work.

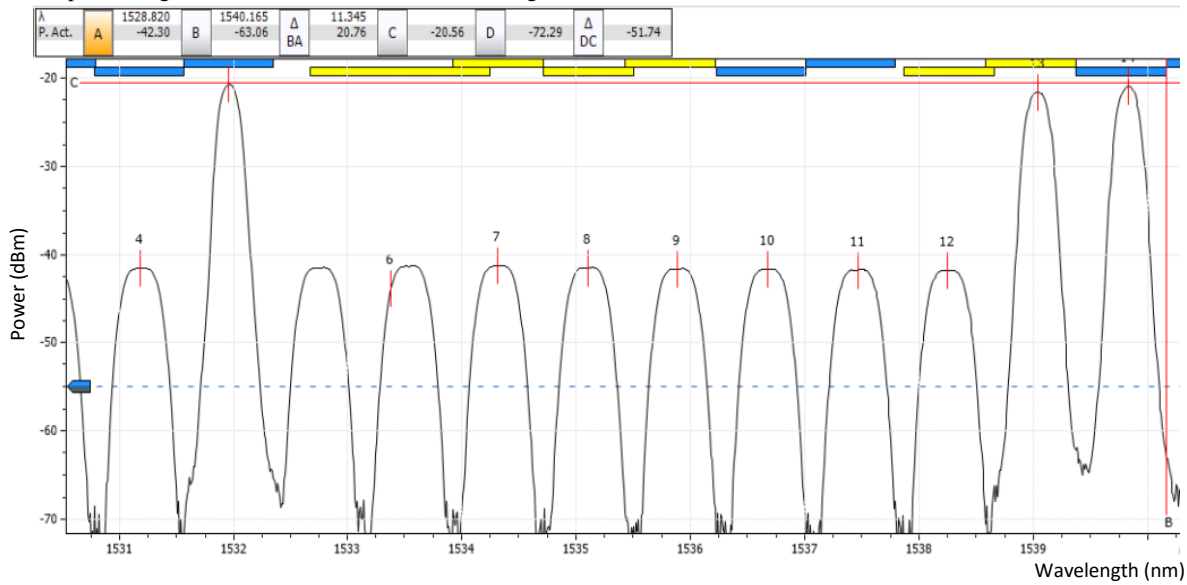

Figure 3. Received signal spectrum on site Z while A site transponder signal is on.

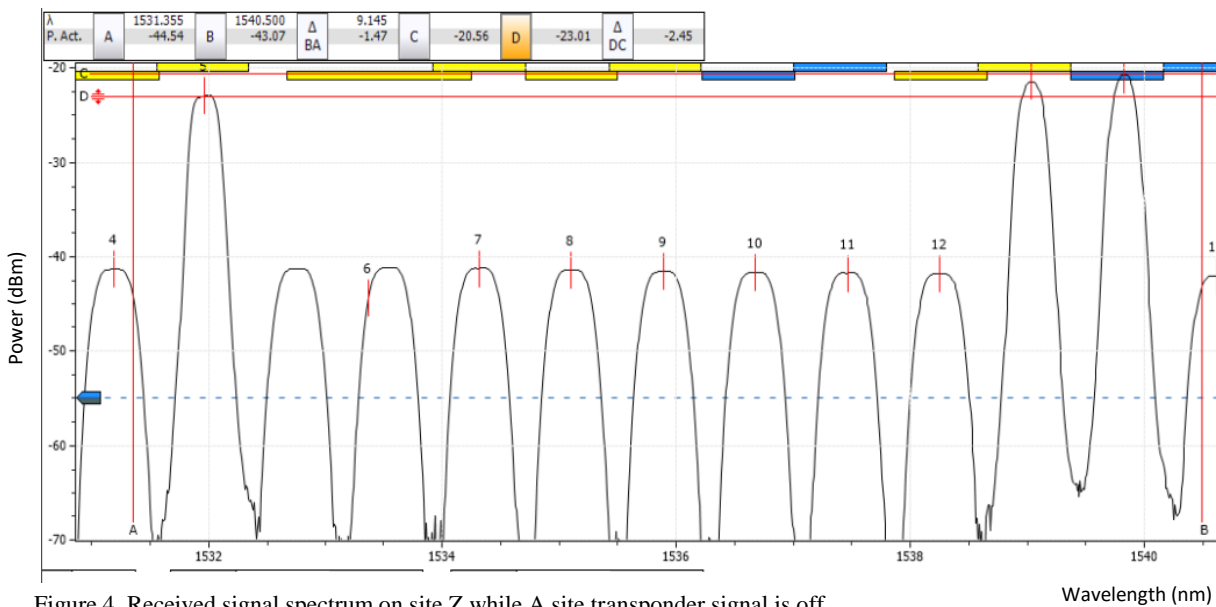

Figure 4. Received signal spectrum on site Z while A site transponder signal is off.

3. PROTECTION MECHANISM OF THE OPTICAL NETWORK

In this section, we analyzed the protection mechanism of the optical network. Formerly, simple optical filters

were used for the protection at the line (by putting the filter between final output of DWDM system and the optical line) or channel (by putting the filter output of the OTU's WDM side). It is also possible to use filters to connect the client side as shown in Fig. 5.

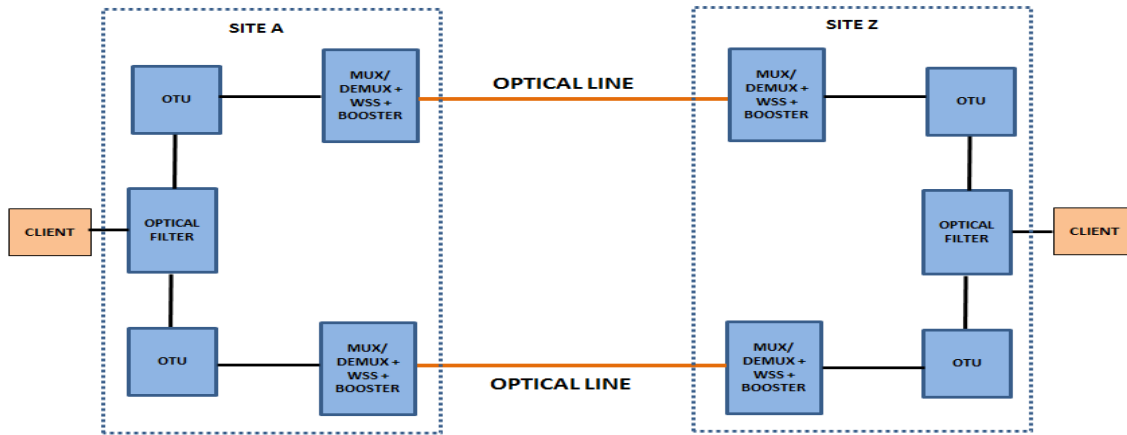

Figure 5. Client side protections by the optical filter

By the recent advances in DWDM systems, new protection mechanisms come into use. WSS boards give capability of switching optical channels in case of cut on the line. WSS boards have maximum attenuation on the empty channels by default. Because the attenuation on the WSS boards of restoration routes will be adjusted to a suitable value (automatically), it

takes some time for the channel to switch.

4. OPTICAL ASON TEST CONFIGURATION

We have done a test with the configuration shown in Fig 6. The test is realized by cutting the line and recording the protection switching durations.

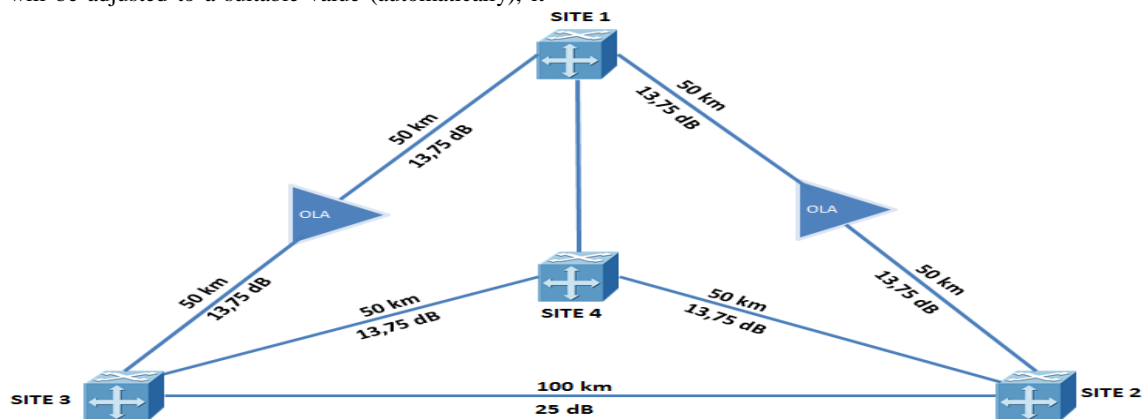

Figure 6. ASON test configuration

When the alternative route is ready (optical power adjustment is already done) switching is achieved by WSS boards resulting about 100ms-300ms which is much more than the standard protection and recovery switching time “50 ms” for typical rings (ITU-T G.8032).

If the alternative route that the channel will be switched is not ready, it means that the optical cross connections and power adjustment are done after the failure of the working route, the switching time can go up to 1 minute. This method corresponds to a lower level

quality of service; there is no dedicated empty channel for protection.

When there is only one route to switch for the channel and there is another channel on that one and only route at the same frequency, as an ASON colorless function, OTUs change the channel frequency and uses the last available route.

NG-DWDM systems also enabled low speed traffics to be cross-connect in to the optical channel with Optical Transport Network frame Structure (OTN ITU-T G709) [9] by using cross-connection boards on the

DWDM equipment. This time switching occurs on the cross-connection boards to the already existing optical channels, switching time is less than 50 ms.

5. CHANNEL POWER BALANCE ON DWDM LINKS

Finally, we analyzed channel power balance on DWDM links. To reduce the interference effect caused by harmonics of optical signals, channel power values

must be on the balance [21]. A high-powered channel's, side bands will also be high, will cause crosstalk and decrease OSNR that may cause to increase the BER [22]. Formerly, DWDM system architecture was terminal to terminal. So power balancing was simple. With ROADMs structure channels that are shown in Fig. 7 are able to pass through over WSS layer as shown in Fig. 8 [23]. This makes channel power balance more complex.

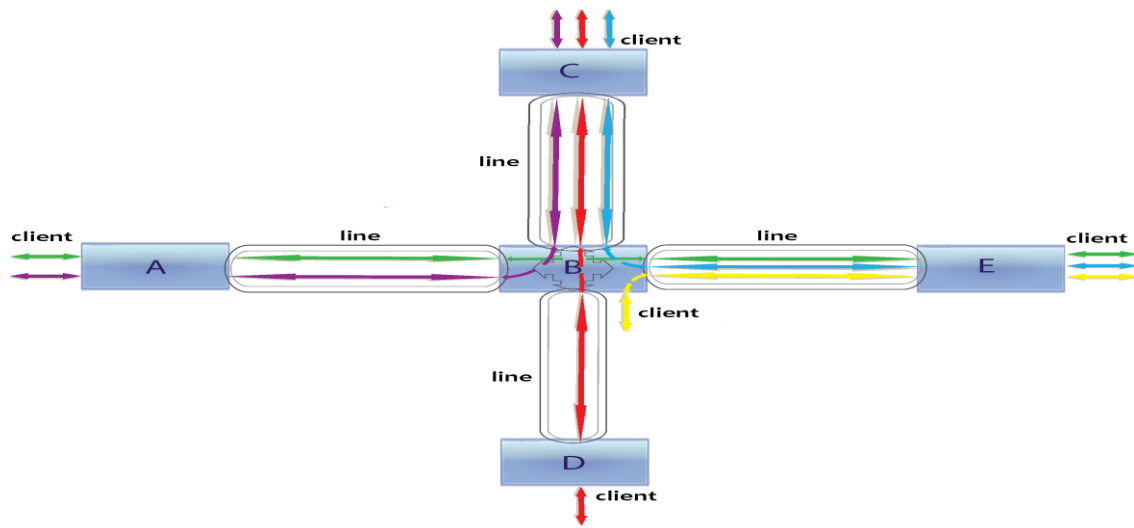

Figure 7. ROADMs structure

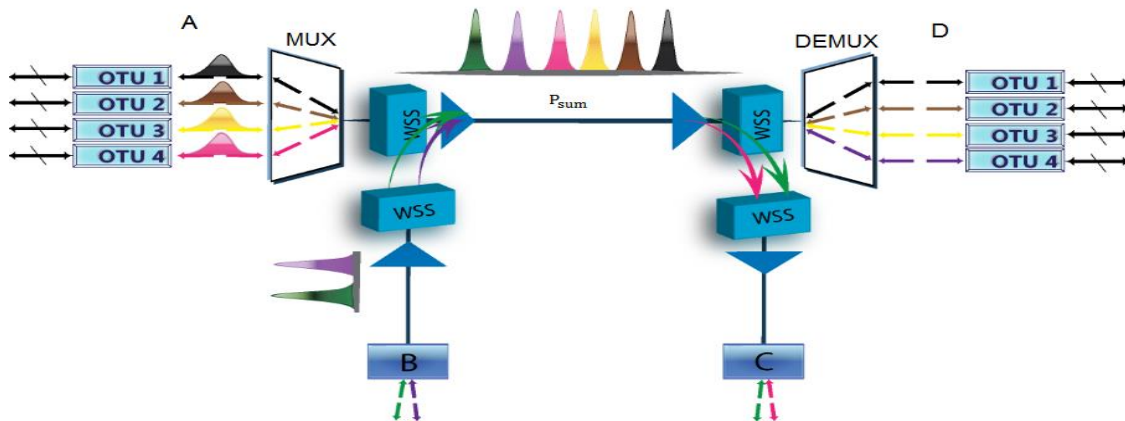

Figure 8. Channel routing by ROADMs

Operators must pay attention to;

- Channel power values must be close to each other
 - The received power of the channels on OTU at both sites, must be in range
 - The sum power of each amplifier must be in range
- (Actually these points are related to each other). If

channel power values are not in balance, there will be interference and low power channels will be at risk. If received power is not in the nominal power range OTU will not be able to demodulate signal correctly. If the input power of the amplifiers (boosters) is not in range, they will not amplify correctly. For example, input signal channels at the input may be in balance but they have all more optical power than the nominal value.

Because sum power is more than the ideal value output signal may have unbalanced channels.

For example, there may be a situation like in Fig. 9. If the operator tries to correct unbalanced channel directly from site B without looking the whole channel route, it

will be a mistake. However, receiving channel power at site C is lower than the other channels, so if we decrease it more, this may cause a traffic cut. So it must be increased at site C first, and then decreased at site B step by step.

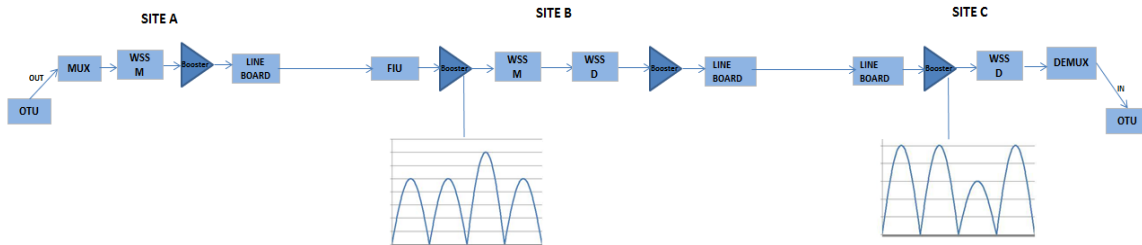

Figure 9. Channel balance configuration

Consider a mesh DWDM network with including a lot of sites and lots of channels working. When the channels are created without power principles, it becomes very hard to solve a failure caused by optical power. When you try to correct one, you may cause interruption on another channel. So the best way is to follow all the criteria while creating optical channels.

6. RESULTS AND CONCLUSION

NG-DWDM systems with ROADMs structure give ability to add/drop channels by WSS layer and increased the channel bit rate by 100Gb/s OTU's. This paper reviews the performance factors come up with these new technologies; in terms of OSNR, optical power from beginning to end, repair time duration on the new protection mechanisms. Because each channel on the DWDM link comes from and goes to different sites, operator must stand on each channel's optical OSNR and performance. From the Telecom Operator's perspective (owning DWDM networks), NG-DWDM has more ability to create and redirect services but need more attention for a healthy transmission environment.

CONFLICT OF INTEREST

No conflict of interest was declared by the authors.

REFERENCES

[1] Huang, Y., Ip, E., Huang, M.F., "10×456 Gb/s DP-16QAM transmission over 8×100 km of ULAF using coherent detection with a 30 GHz analog-to-digital converter", *OECC (2010)*, Sapporo, July 5-9 2010.
 [2] Zhou, X., Yu, J., Huang, M.F., "64 Tb/s (640×107 Gb/s) PDM-36QAM transmission over 320 km using both pre- and post-transmission digital equalization", *J Lightwave Technol.*, 29(4):571-577, (2011).

[3] Patel, A. N., Ji, P. N., Jue, J. P., T., "Routing, wavelength assignment and spectrum allocation algorithms in transparent flexible optical WDM networks", *Opt Switch Netw.*, , 9(3):191-204, (2012).
 [4] Talebi, S., Alam, F., Katib, I., et al.: "Spectrum management techniques for elastic optical networks: A survey", *Opt Switch Netw.*, 13(4):34-48, (2014).
 [5] Singh, S., "Performance investigation on DWDM optical ring network to increase the capacity with acceptable performance", *Optik*, 125(19): 5750–5752, (2014).
 [6] Tiwari, V., Sikdar, D., Navya, M., Jyothi, "Investigation of optimum pulse shape for 112 Gbps DP-DQPSK in DWDM transmission", *Optik*, , 124(22): 5567–5572, (2013).
 [7] Zhou, Z., Xiao, S., Qi, T., "25-GHz-Spaced DWDM-PON With Mitigated Rayleigh Backscattering and Back-Reflection Effects", *IEEE Photonics Journal*, 5(4):7901407-7901407, (2013).
 [8] Schuh, K., Lach, E., Junginger, B., "8 Tb/s (80-107 Gb/s) DWDM NRZ-VSB Transmission Over 510 km NZDSF with 1 bit/s/Hz Spectral Efficiency", *Bell Labs Technical Journal*, , 14(1):89–104, (2009).
 [9] ITU-T Recommendation G.709/Y.1331: "Interfaces for the optical transport network", (2012).
 [10] Hsueh, Y.T., Stark, A., Liu, C., "Passband Narrowing and Crosstalk Impairments in ROADM-Enabled 100G DWDM Networks", *J Lightwave Technol.*, 30(24):3980–3986, (2012).

- [11] Miller, D.A.B., “Reconfigurable add-drop multiplexer for spatial modes”, *Opt Express*, 21(17):20220-20229, (2013).
- [12] Hong, W., Bai, N., Sun, X., “Design of flexible and reconfigurable optical add/drop multiplexer”, *Opt Fiber Technol.*, 17(3):247-251, (2011).
- [13] Goodchild, T., “High Speed Transport Presentation Applications”, *Exfo Application Notes*, (2014).
- [14] Alcatel-Lucent Technology White Paper, “Next-generation Electro-Optics Technology with Coherent Detection”, (2010).
- [15] Sabapathi, T., Manohari, R. G., “Analysis and Compensation of Polarization Mode Dispersion in Single Channel WDM and 32-channel DWDM”, *Optik*, 125(1):18–24, (2014).
- [16] Perlicki, K., Okrasa, W., “Analysis of crosstalk in mixed 40 Gb/s and 100 Gb/s DWDM system with alien wavelength”, *Optica Applicata*, 42(4):829-834, (2012).
- [17] Tibuleac, S., Filer, M., “Transmission Impairments in DWDM Networks With Reconfigurable Optical Add-Drop Multiplexers”, *J Lightwave Technol.*, 28(4):557-568, (2010).
- [18] Singh, S., Kaler, R.S., “Investigation of hybrid optical amplifiers with different modulation formats for DWDM optical communication system”, *Optik*, 124(15):2131–2134, (2013).
- [19] Singh, S., Kaler, R.S., “Performance evaluation of 64×10 Gbps and 96×10 Gbps DWDM system with hybrid optical amplifier for different modulation formats”, *Optik*, 123(24):2199–2203, (2012).
- [20] Li, Y., Dai, H., Shen, G., “Adaptive FEC-based lightpath routing and wavelength assignment in WDM optical networks”, *Opt Switch Netw.*, 14(7):241–249, (2014).
- [21] Patnaik, B., Sahu, P. K., “Ultra high capacity 1.28 Tbps DWDM system design and simulation using optimized modulation format”, *Optik*, 124(13): 1567–1573, (2013).
- [22] Aloisio, A., Ameli, F., D’Amico, A., “Performance Analysis of a DWDM Optical Transmission System”, *IEEE T Nucl Sci.*, 59(2):2, (2012).
- [23] Klabjan D., Borraz, C., “Optimal Placement of Reconfigurable Optical Add/Drop Multiplexers with Packing, Blocking, and Signal Loss”, *Computer Netw.*, 57(6):1443-1458, (2013).