

MONTE-CARLO (MC) ANALYSIS OF BORATED MATERIALS FOR NEUTRON SHIELDING APPLICATIONS

Abdul Rahman ALBAROUDI¹ , Pelin USLU KİÇEÇİ² , Selcen UZUN DURAN^{3,*} ,
M. Bilge DEMİRKÖZ⁴ 

^{1,2,4}The Research and Application Center for Space and Accelerator Technologies, Middle East Technical University, Ankara-Türkiye
³Program of Medical Imaging Techniques, Vocational School of Health Sciences, Karadeniz Technical University, Trabzon, Türkiye

ABSTRACT

Neutron shielding is of utmost importance in radiation environments such as nuclear reactors and particle accelerators and in fields such as health physics. In this work, the percentages of neutrons stopped by shields comprising of boron minerals (HDPE/B₂O₃, Epoxy/Priceite, Epoxy/Colemanite, Epoxy/Kernite) in their composition against neutron radiation of different energies is investigated using two separate MC simulations. Different layer combinations of epoxy based borated shielding materials with HDPE sheets were then simulated to find the optimum shielding configuration. In addition, radioactivation studies were carried out for these designs. The most suitable design was found to be the layered setup of the HDPE sheet and the epoxy/colemanite composite sheet for mixed neutron energies (<1MeV).

Keywords: Neutron shielding, Monte-Carlo simulations, Borated materials, Boron composites.

1. INTRODUCTION

Low energy and thermal neutrons are considered to be of significant threat to human health and electronic equipment [1]. Nuclear reactors and particle accelerators can generate high fluxes of neutron radiation. Therefore, shielding is very important to protect the workers and the equipment in these facilities from the detrimental effects of radiation. In principle, a good neutron radiation shield is composed of a combination of light elements, such as hydrogen (H) and carbon (C) for neutron moderation, and high neutron absorption cross-section (Σ_{abs}) having elements such as boron (B), lithium (Li) and cadmium (Cd) for neutron capture. Therefore, hydrogen-rich polymers can be used to thermalize neutrons ($KE=0.025$ eV at 20 °C) which are then captured and absorbed through boron-containing compounds. The higher the number of stopped neutrons, the better the neutron attenuation efficiency of the shield [2]. High carbon and hydrogen content materials such as polyethylene, paraffin and concrete are typically used against neutrons for protection based on the large and constant nature of the total cross section of neutrons for carbon and hydrogen in the energy range between 0.1 MeV and 0.1 eV as shown in Fig. 1 [3,4]. The high total neutron cross-section of the atoms in a hydrocarbon polymer matrix makes it one of the most effective candidates for low energy applications, especially high-density polyethylene (HDPE), which is a widely used material due to its high density, availability, affordability, and desirable mechanical properties.

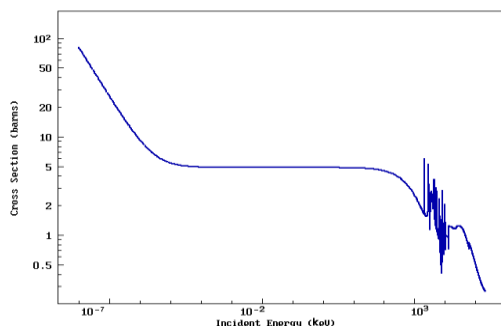

Figure 1. Total neutron cross-section for Carbon-12. [3]

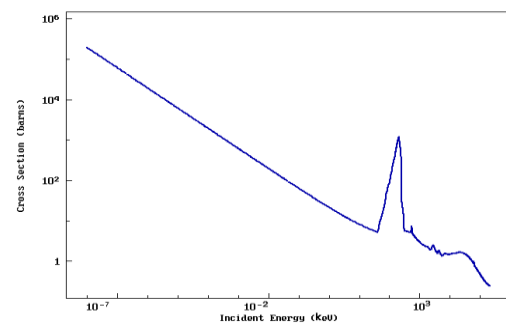

Figure 2. Total neutron cross-section for Boron-10. [3]

* Corresponding author, e-mail: selcenduran@ktu.edu.tr (S. Uzun Duran)

Received: 12.04.2022 Accepted: 18.07.2022

doi: 10.55696/ejset.1102371

Another good neutron shielding material candidate is boron, which has two naturally abundant and stable isotopes, B-10, and B-11. 20% of all-natural boron is B-10 and it has a very high absorption cross-section of slow neutrons to transition into the more stable isotope B-11 [4]. Total neutron cross-section for B-10 is shown in Fig. 2. The high cross-section at the thermal neutron capture region is very favorable for shielding applications, since it results in the production of a stable B-11 nucleus that is not going to decay. This prevents unnecessary activation of the shielding material.

The total neutron cross-section B-10 and its production of B-11 daughters, along with its relatively high natural abundance, makes it a very good contender for shielding materials against low energy neutrons compared to other alternatives, such as heavy metals, which can be poisonous, and add significant weight to the shielding. Boron is lighter, safer, and much more available [5]. In this work, the effect of adding boron salts and boron containing minerals into existing shielding setups is investigated using Monte-Carlo simulation methods with the Geant4 toolkit and MCNP6. The aim of this study is to find the optimum shielding configuration by determining the percentages of neutrons stopped in their compositions against neutron radiation of different energies by shields made of boron minerals (HDPE/B₂O₃, Epoxy/Priceite, Epoxy/Colemanite, Epoxy/Kernite).

2. MATERIAL AND METHOD

2.1. Monte-Carlo Simulations

In applications involving radiation, Monte Carlo method and simulation technique provide modeling and animation of experimental conditions in computer environment. With this method, devices and materials producing radiation can be simulated in the computer environment and exposed to radiation. Products doped with different materials can be tested without the physical difficulties caused by the experimental conditions, and a wide range of material analysis can be performed inexpensively.

The Monte-Carlo analysis in this work is done using Geant4 and MCNP6. A C++ program using the Geant4 toolkit was written to evaluate the performance of the different suggested shielding configurations by sending in a beam of neutrons with normal incidence towards the shield [6]. The percentage of neutrons that are completely stopped inside the shield is used as a measure of performance. Slowed down neutrons and thermal energy neutrons are still considered to be highly damaging, thus only neutrons that lose all their kinetic energy and are absorbed by the shielding material are accounted for in this case. Nevertheless, the slowing down of neutrons inside polyethylene is also investigated as a part of the effort to obtain the optimum boron concentration.

The neutron gun in the simulation is rectangular, 2.0×2.0 cm in size and placed 50 cm from the target. The gun has multiple energy settings with monoenergetic and mixed energies representing high energy (HE) and low energy (LE) regions for neutrons. Therefore, samples can be tested for neutrons in different energy ranges. The different energy settings of the gun can be found in Table 1. The high and low energy linear spectra are meant to represent the behavior of mixed neutron energy distributions within shielding materials.

Table 1. Neutron beam energy specifications defined in Geant4 simulation

ENERGY SETTING	ENERGY	SPECTRUM
Thermal neutrons	0.025 eV	Mono-Energetic
Epithermal neutrons	0.2 eV	Mono-Energetic
Slow neutrons	5 eV	Mono-Energetic
Fast neutrons	20 MeV	Mono-Energetic
High Energy (HE)	1 MeV-1 keV	Linear Gradient = 1 intercept = 1
Low Energy (LE)	1 keV-1 eV	Linear Gradient = 1 intercept = 1

The prepackaged physics list FTFP-BERT-HP was used along with the G4ENDL4.5 datasets to achieve the most accuracy in the Geant4 simulation [6]. This physics-list is modified form the original FTFP-BERT for high energy physics experiments to add high precision calculations for low energy neutron interactions. However, it does not allow for radioactive decay to take place, which is necessary to observe the effects of the activation of the shielding material. It also lacks the inclusion of low energy electromagnetic processes. But since the simulation runs for only neutrons as incident particles and to make the simulation more efficient, this physics-list was chosen. As for the study of activation, FLUKA was used to qualitatively determine the radioactive isotopes produced by each proposed shielding material.

MONTE-CARLO (MC) ANALYSIS OF BORATED MATERIALS FOR NEUTRON SHIELDING APPLICATIONS

Layers of materials are placed against the neutron beam with a scoring volume on the opposite side as shown in Figure 3. The layers have lateral dimensions of 30.0×30.0 cm. The thickness of the target material was selected as 1 cm and 5 cm to observe the efficiency and the scaling effect on the shielding performance. The scoring volume behind is 20% larger in area to account for particles exiting the shielding layer with large momentum components in the lateral direction.

The Monte-Carlo analyses were also performed using MCNP6. It is a general-purpose code that is developed by Los Alamos Laboratory to track many particle types over a broad range of energies. The beam energy and geometry were the same as in Geant4. Stopping percentages of the shielding materials were found using the F1 tally. It calculates the particle current passing from the target surface. Therefore, this tally is used for the calculation of the percentages of the stopping neutrons in the shielding material.

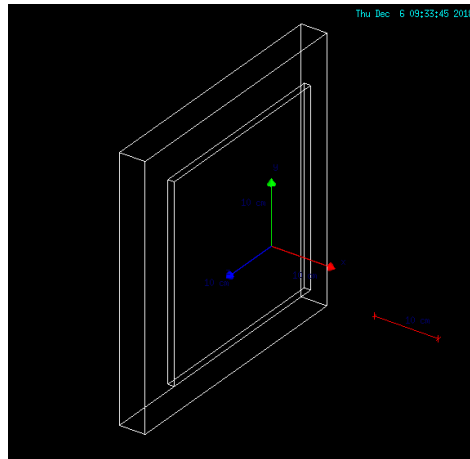

Figure 3. Single sheet testing setup inside Geant4 environment.

2.2. Candidate Material Selection

HDPE and HDPE/B₂O₃ composites are widely used as effective neutron shielding materials, but they have poor mechanical strength, heat resistance and durability [1-7-8]. Epoxy resin is used for coating floors in radiation facilities since it has good durability against gamma ray and neutron irradiation. Therefore, a mix of epoxy resin with boron carbide is used in a nuclear fuel cask, but boron carbide is very expensive. Therefore, a new neutron shielding material based on colemanite and epoxy resin was developed, and its shielding performance was also estimated in this study [9].

Valuable boron compounds such as colemanite (Ca₂B₆O₁₁·5H₂O), tincal (Na₂B₄O₇·5H₂O) and ulexite (NaCaB₅O₉·8H₂O) have found various application areas [10]. Colemanite, tincal and ulexite are thoroughly investigated in literature [10-11-12-13-14-15-16]. On the other hand, studies about kernite (Na₂[B₄O₆(OH)₂]·4H₂O) and Priceite (Ca₂B₅O₇(OH)·5H₂O) minerals and their neutron shielding effects are limited.

In this study, borated HDPE is tested to show an improvement on the thermal neutron absorption of HDPE as boron is added into the polymer matrix uniformly. The aim is to use the large carbon content to slow down the energetic neutrons to thermal energies via scattering, at which point a B-10 nucleus is 104 times more likely to capture the neutron than any other atomic constituent of HDPE. There exist many commercial setups for the incorporation of powders into the HDPE polymer matrix that would be useful for such purposes [18].

The thermal, electrical, and surface characteristics of such a composite material is thoroughly investigated in the literature [1,5,15-20]. The amount of boron inside the shield was changed to see the effects of increasing boron concentration in the mixture and whether an optimum composition exists. Also, the thicknesses of the shields were changed as 1 and 5 cm.

Other materials were tested with polyethylene in layered setups using the same working principle. Boron rich minerals infused within epoxy resins were tested, including Kernite (Na₂[B₄O₆(OH)₂]·4H₂O), Priceite (Ca₂B₅O₇(OH)·5H₂O) and Colemanite (CaB₃O₄(OH)₃·H₂O). These materials are readily supplied commercially as solid sheets and powders. Each candidate was tested in a setup in which a 2.5 cm thick layer of the material was placed either before or after a similarly sized HDPE layer. 55% epoxy and 45% boron mineral were used in each material. The volumetric makeup of the composite material is given in Table 2.

Table 1. Volumetric breakdown of the composition of the shielding sheet material.

	Mineral	Epoxy
% Volume	55%	45%

2.3. Binning and Data Analysis

Neutrons exhibit a highly probabilistic behavior when interacting with matter. Two neutrons of the same energy may pass the same thickness of shield with one experiencing negligible energy loss and the other being completely absorbed by it. Therefore, Monte-Carlo simulations must incorporate a very high number of primary particles and average the results over all events to assess the integrated effect of all particles. By binning specific energy ranges and averaging interactions over it, the shield's performance can be assessed. The slowdown of neutrons inside the shield was calculated from the kinetic energies of neutrons using the following formula:

$$\%slowdown = \frac{\sum_i^n ((E_i(i) - E_f(i)) / E_i(i))}{n} * 100 \quad (1)$$

Where n is the number of particles inside the bin, $E_i(i)$ is the initial energy of the i th neutron in the bin, $E_f(i)$ is the energy of the i th neutron after passing through the shield.

3. RESULTS AND DISCUSSION

3.1. Borated Polyethylene

Using the Monte-Carlo simulations and using the equation defined in the method, a 5 cm thick borated HDPE sheet with different percentages of boron slowed down neutrons with effectiveness shown in Fig. 4.

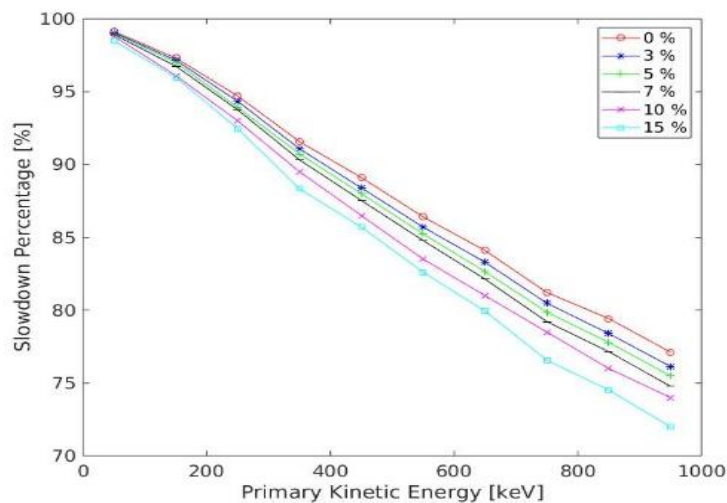

Figure 4. Neutron stopping percentages of HDPE sheet, depending on different neutron energies and different boron ratios.

As the concentration of boron inside polyethylene increases, the advantage gained diminishes. That is because as the percentage of boron increases, the number density of carbon decreases, making it less probable for the neutron to scatter off it and thus compromising the potential of the boron capturing it.

The simulation was repeated while changing the thicknesses and the energy ranges of the beam to better visualize the advantages of certain concentration values and to determine the optimum concentration of boron in the sheet. A 1 cm thick sheet was subjected to the beam and the amount of stopped neutrons was counted for by different beam energy settings, the results of which are shown in Fig. 5-a.

The difference in the shielding effectiveness between pure HDPE and borated HDPE is very significant at low neutron energies. The concentration of boron has a decaying effect on the shielding efficiency after 5% for low energy neutrons. For higher energy neutrons, the effect is very subtle and is not significant. The minor change in shielding performance is shown in Fig. 5-b to emphasize more on how the shield interacts with the mixed energy beam HE and LE.

MONTE-CARLO (MC) ANALYSIS OF BORATED MATERIALS FOR NEUTRON SHIELDING APPLICATIONS

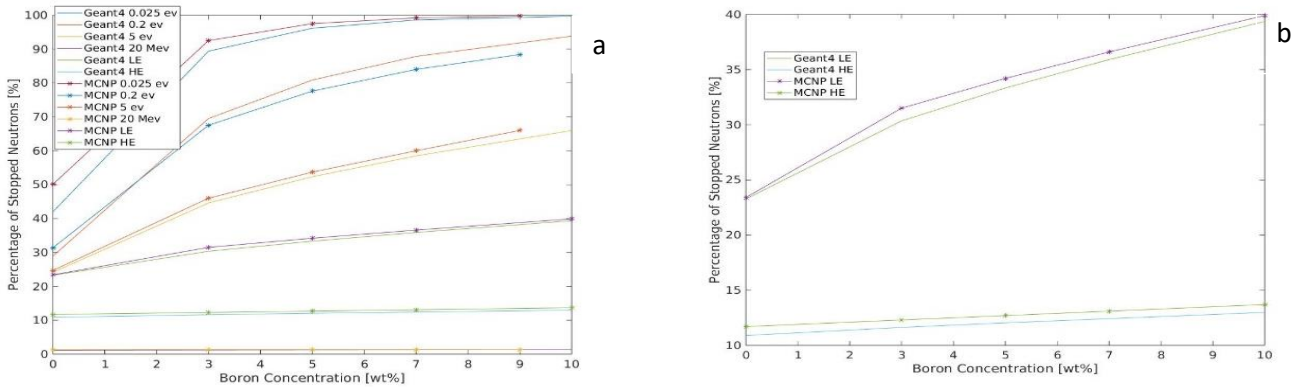

Figure 5-a: The Percentage of stopped neutrons of 1 cm thick HDPE, depending on the boron ratio. **5-b:** The Percentage of stopped neutrons of 1 cm thick HDPE sheet, for HE and LE neutrons, depending on different boron ratios. Error bars < 0.1%.

Fig. 5-b shows that the LE beam achieves more shield penetration with increasing boron concentration, while the HE beam exhibits the opposite behavior. Upon further investigation by sending a linear energy spectrum with the same parameters between 1 MeV and 1 eV and increasing the thickness to 5 cm, a peak in the shield performance can be seen at 5% boron concentration in Fig. 6-a. This observation further verifies the explanation behind the diminishing return of stopping neutrons on increasing boron concentrations, since boron has a low cross-section of absorption for high energy neutrons and less carbon is present to scatter the energy off. This effect being more prominent at 5 cm thickness is to be expected since addition of more shielding material will provide enough scattering medium to emphasize this effect.

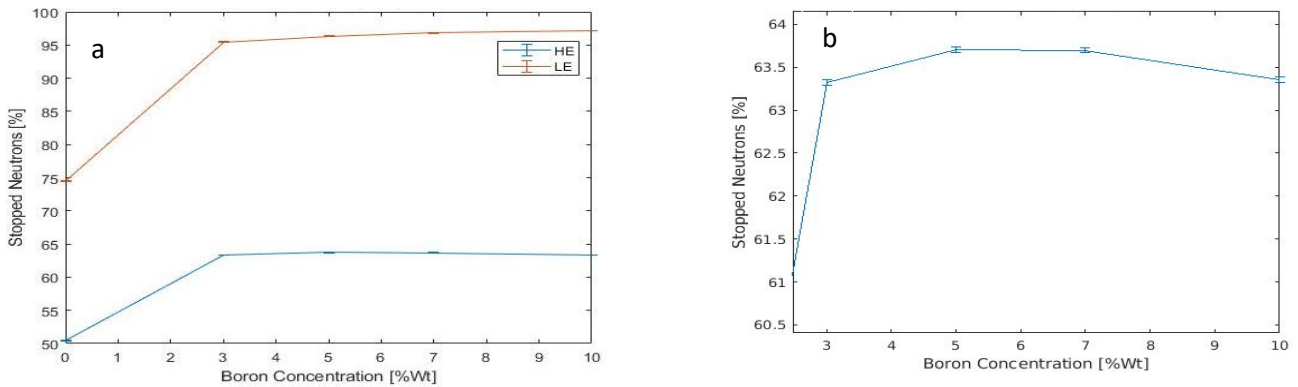

Figure 6-a. The Percentage of Stopped Neutrons of 5 cm Thick HDPE Sheet, For HE and LE Neutrons, Depending on Different Boron Ratios. **Figure 6-b.** Close-Up of The HE Neutrons Results.

The scaling up of the behavior of neutrons with the thickness of the shield can be seen in Fig. 7, in which a comparison of the two thicknesses is made for the LE beam. The biggest jump in performance is again made at 5% boron concentration, after which the gain in performance diminishes significantly. Close to 96% of LE neutrons are shown to be stopped by a mere 5 cm thickness of this lightweight shield.

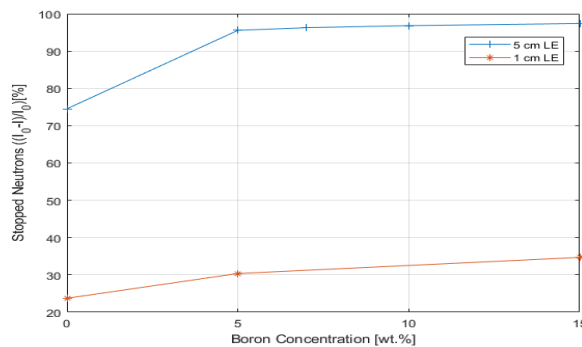

Figure 7. Comparison between the performance of the shield at 1 cm and 5 cm. Plotted for the LE beam.

3.2. Epoxy/Boron Composites

Sheets of epoxy resin incorporating boron rich minerals (Colemanite, Priceite and Kernite) were tested using the same simulation environment as borated polyethylene. First, colemanite sheets were tested at thicknesses of 1 and 5 cm and with both beam configurations. The results can be seen in Fig. 8.

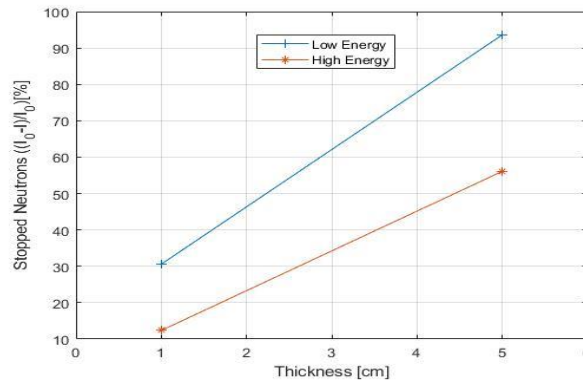

Figure 8. The percentage of stopped neutrons relative to the thickness of the epoxy-colemanite-containing sheet for LE and HE neutrons.

At high energies, Epoxy/Colemanite composite behaves poorly compared to Polyethylene due to the lower concentration of carbon and hydrogen atoms in the material. However, when using LE beam, the sheet achieves a significant increase in performance over pure polyethylene even at 1 cm thickness.

The same behavior is consistent across other mineral candidates as can be seen from Table 3 for 5 cm thickness. Amongst the three tested candidates, Epoxy/Colemanite showed the best performance.

Table 3. The percentage of stopped neutrons compared for different minerals in the epoxy composite in addition to layered setups with HDPE for HE and LE beams at 5 cm thickness. Error bars < 0.1%.

Type of Composites	Material	Stopped Neutrons $((I_0-I)/I_0)$ [% ± 0.1]	
		HE	LE
Epoxy Composites	E/Priceite	54.1	93.4
	E/Kernite	51.4	91.6
	E/Colemanite	57.7	95.0
HDPE + Composites	HDPE First + E/Colemanite	62.1	96.8
	HDPE Last + E/Colemanite	56.1	93.6

A compound shield setup was proposed involving two layers totaling 5 cm in thickness, the first of which is a 2.5 cm polyethylene sheet, and the latter is a 2.5 cm composite sheet to harness the effectiveness of the materials at low energies. The aim is to use the polyethylene for slowing down the fast neutrons before they reach the epoxy/boron composite. The beam was set to hit the pure polyethylene sheet first, and again to hit the composite sheet first to test this hypothesis. Results, presented in Table 3, show a significant advantage to placing polyethylene before the borated composite. The combined assembly achieves a higher performance than a single layer polyethylene or the composite of the same total thickness.

3.3. Activation

Depending on the nuclei present in the shielding material and their concentrations, radioactive isotopes may be formed as the material is exposed to neutron radiation. The proposed materials were tested for production of radioactive isotopes in MC simulations for neutrons < 20 MeV. Since Colemanite and Priceite are comprised from the same elements with different compositions, they have similar activation properties. The most prominent radioisotopes for Colemanite and Priceite after neutron irradiation are B^{12} , N^{16} and Li^8 . These isotopes have relatively short half-lives (max 7.2 s for N^{16}) and would quickly cool down after the irradiation is stopped. Other isotopes with half-lives in the order of days are also produced such as (Ca^{47} , Ca^{45} , Sc^{47} , K^{44}), but these isotopes are produced with much lower rates (5 orders of magnitude). This could eventually limit the

MONTE-CARLO (MC) ANALYSIS OF BORATED MATERIALS FOR NEUTRON SHIELDING APPLICATIONS

lifetime these materials can be used depending of the neutron flux and the amount of shielding used. In the same manner, the sodium in Kernite generates radioactive isotope such as (Na^{24} , Ne^{23} , Mg^{23} , Na^{22}) which have half-lives that are marginally shorter than Colemanite and Priceite. Making it slightly better suited for high flux and long exposure scenarios.

4. CONCLUSION

Different boron containing materials have been studied through MC analysis using Geant4 and MCNP6. Borated HDPE and different epoxy/boron composites were tested for their neutron shielding performance and compared to each other at different energy regimes. Effects of thicknesses and ordering of multi-layered shields were also investigated. The optimal concentrations for borated polyethylene shields were found at 5 wt.%. The slowdown behaviour of neutrons was also tested as a function of incident neutron energy. The multi-layered shield of HDPE with the Epoxy/Colemanite composite has been shown to have superior shielding characteristics among the tested materials, along with its better availability and affordability.

SIMILARTY RATE: 7%

ACKNOWLEDGEMENT

The work was supported by grants from TUBITAK (5190039).

REFERENCES

- [1] J.W. Shin, J.W. Lee, S. Yu, B.K., Beak J.P. Hong, Y. Seo, W.N. Kim, S.M. Hong, C.M. Koo, "Polyethylene/boron-containing composites for radiation shielding", *Thermochimica Acta*, vol. 585, pp. 5-9, 10 June 2014. <https://doi.org/10.1016/j.tca.2014.03.039>.
- [2] S. T. Abdulrahman, Z. Ahmad, S. Thomas, A. A. Rahman, "Chapter 1-Introduction to neutron-shielding materials," in *Micro and Nanostructured Composite Materials for Neutron Shielding Applications*, Woodhead Publishing Series in Composites Science and Engineering, pp. 1–23, 2020.
- [3] International Atomic Energy Agency, "NGATLAS: Atlas of Neutron Capture Cross Sections," March 2014.
- [4] J.C. Sublet, A.J. Koning, D. Rochman, M. Fleming, M. Gilbert, "Delivering Both Completeness and Robustness", In *Advances in Nuclear Nonproliferation Technology and Policy Conference*, Santa Fe, NM, USA. Sept. 25-30, 2015.
- [5] Ş.G. İrim, A.A. Wis, M.A. Kestin, O. Baykara, G. Ozkoc, A. Avcı, M. Dođru, M. Karakoç, "Physical, mechanical and neutron shielding properties of h-BN/Gd₂O₃/HDPE ternary nanocomposites", *Radiation Physics and Chemistry*. Vol. (144), pp. 434-443. March 2018. <https://doi.org/10.1016/j.radphyschem.2017.10.007>.
- [6] CERN, "Geant4 User's Guide for Application Developers," 2016.
- [7] X. Campo, R. Méndez, M.A.S. Lacerda, D. Garrido, M. Embid, J. Sanz, "Experimental evaluation of neutron shielding materials", *Radiation protection dosimetry*. Vol. 180, no. (1-4), pp. 382-385. 1-4-August 2018. <https://doi.org/10.1093/rpd/ncx202>.
- [8] X. Zhang, M. Yang, X. Zhang, H. Wu, S. Guo, Y. Wang, "Enhancing the neutron shielding ability of polyethylene composites with an alternating multi-layered structure", *Composites Science and Technology*, vol. 150, pp. 16-23, 29 September 2017. <https://doi.org/10.1016/j.compscitech.2017.06.007>.
- [9] K. Okuno, "Neutron shielding material based on colemanite and epoxy resin", *Radiation Protection Dosimetry*, vol. 115, no. 258-261, 20 December 2005. <https://doi.org/10.1093/rpd/nci154>.
- [10] F. Demir, A. Un, "Radiation Transmission of Colemanite, Tincalconite and Ulexite For 6 And 18 MV X-Rays By Using Linear Accelerator", *Applied Radiation and Isotopes*, vol. 72, pp. 1-5, February 2013. <https://doi.org/10.1016/j.apradiso.2012.09.020>.
- [11] T. Korkut, A. Karabulut, G. Budak, B. Aygün, O. Gencel, A. Hançerliođları, "Investigation Of Neutron Shielding Properties Depending On Number Of Boron Atoms For Colemanite, Ulexite And Tincal Ores By Experiments And FLUKA Monte Carlo Simulations", *Applied Radiation and Isotopes*, vol. 70 no. (1), pp. 341-345, January 2012.
- [12] H. Binici, O. Aksogan, A.H Sevinc, A. Kucukonder, "Mechanical and Radioactivity Shielding Performances Of Mortars Made With Colemanite, Barite, Ground Basaltic Pumice And Ground Blast Furnace Slag", *Construction and Building Materials*, vol. 50, pp. 177-183, 2014. <https://doi.org/10.1016/j.conbuildmat.2013.09.033>.

- [13] G. Cosansu, C. Cogun, “An Investigation On Use Of Colemanite Powder As Abrasive İn Abrasive Waterjet Cutting (AWJC)”, *Journal Of Mechanical Science And Technology* vol. 26, no. 8, pp. 2371-2380. DOI 10.1007/s12206-012-0619-9, 2012.
- [14] C. Kaynak, N.A. Isitman, “Synergistic Fire Retardancy of Colemanite, A Natural Hydrated Calcium Borate, in High-Impact Polystyrene Containing Brominated Epoxy and Antimony Oxide”, *Polymer Degradation and Stability* vol.96, no.5, pp.798-807, May 2011. <https://doi.org/10.1016/j.polymdegradstab.2011.02.011>.
- [15] N.A. Isitman, C. Kaynak, “Effect of Partial Substitution Of Aluminum Hydroxide With Colemanite İn Fire Retarded Low-Density Polyethylene”, *Journal of Fire Sciences* vol. 31, no. 1, pp. 73-84, August 2 2013. <https://doi.org/10.1177/0734904112454835>.
- [16] R. Bagheri, S.P. Shirmardi, R. Adeli, “Study on Gamma-Ray Shielding Characteristics Of Lead Oxide, Barite, And Boron Ores Using MCNP-4C Monte Carlo Code And Experimental Data”, *Journal of Testing and Evaluation* vol. 45, no. 6, pp. 2259-2266, 24 January 2017. DOI: 10.1520/JTE20160284.
- [17] K. Okuno, M. Kawai, H. Yamada, “Development Of Novel Neutron Shielding Concrete”, *Nuclear Technology* vol. 168 no. 2, pp. 545-552, 10 Apr 2009. <https://doi.org/10.13182/NT09-A9241>.
- [18] J. Kim, B.C. Lee, Y.V. Uhm, W. H. Miller, “Enhancement of Thermal Neutron Attenuation of Nano-B4C-BN Dispersed Neutron Shielding Polymer Nanocomposites”, *Journal of Nuclear Materials* vol. 453 no. 1-3, pp. 48-53, October 2014.
- [19] T. Özdemir, A. Güngör, A.İ. Reyhancan, “Flexible Neutron Shielding Composite Material of EPDM Rubber With Boron Trioxide: Mechanical, Thermal Investigations And Neutron Shielding Tests”, *Radiation Physics and Chemistry* vol. 131, pp. 7-12, February 2017. <https://doi.org/10.1016/j.radphyschem.2016.10.012>.
- [20] A.S. Kipcak, P. Gurses, E.M. Derun, N. Tugrul, S. Piskin, “Characterization of Boron Carbide Particles And Its Shielding Behavior Against Neutron Radiation”, *Energy conversion and management* vol. 72, pp. 39-44, August 2013. <https://doi.org/10.1016/j.enconman.2012.08.026>.

