



On the Dynamic Analysis of Freight Wagon-Track Interaction

Aslı SOYİÇ LEBLEBİCİ¹, Semiha TÜRKAY^{*2}

¹ Eskişehir Osmangazi Üniversitesi, Eskişehir Meslek Yüksekokulu, Elektronik ve Otomasyon Bölümü, Eskişehir, Türkiye

² Eskişehir Teknik Üniversitesi, Mühendislik Fakültesi, Elektrik Elektronik Mühendisliği Bölümü, Eskişehir Türkiye

*semihaturkay@eskisehir.edu.tr

(Alınış/Received: 15.09.2022, Kabul/Accepted: 27.01.2023, Yayımlama/Published: 31.01.2023)

Abstract: In this study, a six-degrees-of-freedom half-car model for a freight wagon is used to study the ride motions of the vehicle under random rail inputs. As a rail input, the track profiles taken from Federal Railroad-Administration (FRA) international standard are used. A coupled vertical vehicle-track system is formed as a polytopic function of the track roughness parameter and vehicle speed and their influence on the vehicle dynamics is discussed. Then an optimization problem with a single objective function is formulated for a range of track roughness parameters and vehicle speeds. \mathcal{H}_∞ control focuses on obtaining a robustness concerning the uncertainty of the system. So, we used \mathcal{H}_∞ optimization to obtain the solutions while maximizing the trade-off between the respective performance indices. Later, a controller with a fixed speed value is synthesized and the results are compared by using the frequency response plots and the root-mean-square values of the car body accelerations and secondary and primary suspension deflections. The simulation results demonstrate that the active system is effective in improving ride comfort while keeping the rail holding within allowable limits.

Keywords: Wagon, H_∞ control, Speed characteristics, Track roughness parameter

Yük Vagonu-Hat Dinamik Analizi

Öz: Bu çalışmada, bir yük vagonu için altı serbestlik dereceli yarım araç modeli, rassal ray girdileri ile uyarılmış aracın düşey sürüş hareketlerini incelemek için kullanılacaktır. Rassal ray girdisi olarak, Federal Railroad Administration (FRA) uluslararası standardı tarafından tanımlanmış iz profilleri kullanılacaktır. Birleştirilmiş düşey araç-iz sistemi polytopic bir fonksiyon olarak iz pürüzlülük parametresi ve araç hızı cinsinden oluşturulmuştur ve araç dinamiği üzerindeki etkileri tartışılmıştır. Daha sonra, tek amaçlı optimizasyon problemi, çeşitli araç hızları ve pürüzlülük parametreleri için formüle edilmiştir. \mathcal{H}_∞ denetleyicisi sistemin belirsizliklerini göze alarak gürbüzlük elde etmeyi hedefler. Bu nedenle sonuçlar \mathcal{H}_∞ optimizasyonu kullanılarak, ilgili performans endeksleri arasında en yüksek uzlaşım eğrilerini elde etmek için kullanılmıştır. Çalışmanın son kısmında, sabit hızlı bir denetleyici sentezlenmiştir ve sonuçlar araç gövdesi ivmeleri, ikincil ve birincil süspansiyon deformasyonları için frekans yanıt grafikleri ve kare-kök-ortalama değerleri kullanılarak karşılaştırılmıştır. Yapılan benzetim çalışmaları, aktif sistemin sürüş konforunu iyileştirirken, ray tutuşunu izin verilen limitlerde korumakta başarılı olduğunu göstermiştir.

Anahtar kelimeler: Vagon, H_∞ denetleyicisi, Hız karakteristikleri, Hat pürüzlülük indeksi

1. Introduction

Railway transportation is a good solution with its cheaper, safer, and environmentally friendly structure to carry more passengers and goods. To be more preferred, it is needed to increase vehicle speeds. Unlike other transportation systems, vehicle speeds are limited by the track geometry [1]. The existing traditional lines which provide mixed passenger and freight train traffic may not meet the higher speed demands since the track needs to take both freight and passenger train into account, and it must restrict the maximum weight, length, and speed. Although the high costs, building more straight lines which are dedicated to high-speed passenger trains is a solution [2]. Another problem especially for the traditional lines is track maintenance. The vehicle forces that are transmitted from the wheels to the track create ground vibrations which are the main source of track degradations [3]. Although the engineering challenges are greater, especially in high-speed passenger vehicles, the railway industry abstains from applications of active systems in practice because of the high costs and the complexity disadvantages.

The higher speeds on both passenger and freight trains increase the dynamic response of the track. However, unlike passenger trains, freight wagons don't have a primary suspension between the wheels and the bogie frames. The Y25 bogie has been a UIC standard freight bogie since 1967 with the suspension structure as friction dampers and intertwined coil springs. In [4], a bogie-based and car body-based wheel flat detection was evaluated for the Y25 bogie to determine the eventual hardware robustness and signal processing requirements. Here, various vehicle operating conditions and wheel flat defects were simulated to analyze the wheel flat impact propagation throughout the railway vehicle bodies. The studies in [5, 6] show that, at the same speed, the freight train effects on the track dynamic are larger than the passenger trains. Separating the rail lines for freight and passenger vehicles might be a solution. However, the freight trains due to their heavier load still cause ground vibrations, especially in the 4-30 Hz frequency range. In this range of frequencies, if the amplitude of vibration is sufficient, it can be felt and in addition to track degradations it may cause disturbances for people living near the railways and damage to lineside structures [7]. Acceptable sinusoidal vibration levels for various living and working areas are listed in BS 6472 [8] and depend on many factors such as time of day and building usage. An effective solution to overcome the freight train-induced vibrations can be utilized by predicting the vibrations at the source. BS ISO 14837 Part 1 [9] provides guidelines on the essential considerations associated with developing prediction models and shows in outline the stages to be observed for new or modified rail systems. The other suggested solution in the literature is the propagation of the vibration from the source to the receiver or reducing the vibration effects on the receiver as in [10]. Much research has been undertaken to understand the transmission of the vibrations and to find some mitigation methods. A global optimum solution is achieved by implementing active suspensions providing variable suspension parameter features of combined utilization of sensors, controllers, and actuators. In the field of local vehicle measurements, a promising proportional–integral–derivative (PID) type control is utilized [11], where the optimization procedures to enhance the performances of the PID approach while maintaining the required robustness of the controller are used. Zhou et al. [12] proposed a decentralization method to separate the tilting and lateral dynamics based on measurements of lateral acceleration, actuator roll, and suspension deflection. Colombo et al. [13] used a similar approach to [12], in terms of feedforward and feedback combination to test three different control methods, showing that a combination of feedforward, PID, and sky-hook controls could provide the best performance in terms of ride comfort for an acceptable actuation power requirement. However, feedback signals measured on the vehicle can introduce issues in the control application. To counteract this problem, in [14] a robust state estimation based on \mathcal{H}_∞ filtering is introduced to estimate the vehicle body lateral acceleration and true cant deficiency. The \mathcal{H}_∞ filtering was then compared with a standard Kalman filter showing good results. Model-based controls including \mathcal{H}_∞ and linear-quadratic-Gaussian (LQG) can produce better performances but at the same time, they can

suffer from unmodelled behaviors and parameter uncertainties. An interesting application considering a lumped track model is studied in [15], where an LQG control is used effectively to counteract the bounce and pitch motions of the car body. A hybrid control that considers the robust \mathcal{H}_∞ control to overcome the problem of uncertainty on the control parameters is studied in [16]. However, a polytopic representation is one of the most general ways to describe without any conservatism suspension parameter uncertainty. In [17], a state feedback controller is designed based on the parameter-dependent Lyapunov approach and the use of convex optimization algorithms.

The paper is organized as follows: In section 2, a six-degrees-of-freedom (6 DOF) mathematical model for the freight wagon excited with an irregular rail profile is presented. In Section 2, it is shown that the response to the excited oscillations depends on the dynamic properties of the vehicle’s model, driving speed, and rail roughness. The effect of forward velocity and track quality is studied extensively. To ensure complacent riding and a good track holding an active control with \mathcal{H}_∞ state feedback methodology is designed in Section 4. \mathcal{H}_∞ control methodology is chosen since it is used for worst-case scenarios and is going to be adapted to reduce the dominant effect of different speeds on uncertain track surfaces. A convex parameterization of all stabilizing controllers for the polytopic system is defined while the performance specifications are defined in $\mathcal{L}_2/\mathcal{L}_\infty$ norms to obtain the best trade-off. \mathcal{H}_∞ control focuses on obtaining robustness concerning the uncertainty of the system. We used $\mathcal{L}_2/\mathcal{L}_\infty$ norms to maximize the trade-off between the respective/concerned performance indices. The simulation results are used to illustrate the effectiveness of the proposed synthesis method in the frequency range of 4-200 Hz. The paper is concluded with concluding remarks in Section 5.

2. The Dynamics of the Freight Wagon

A schematic description of the side view of the Y25 freight wagon is shown in Figure 1 and is going to be used as the basis for the mathematical model of the system, considering both the heave and pitch motions of the car body and bogie masses. Here, the secondary and primary suspensions are represented with coil springs connected in parallel to dry friction dampers and are connected by Lenoir-Link to carry the vertical load to the bogie center. The secondary suspension is aimed to improve the ride quality of the vehicle, while the primary suspension is mainly used for guiding the vehicle. Since only the rigid motion of the vehicle is considered, the primary suspension force F_m is represented by the deflections across the primary springs as

$$F_m = -k_1 x_m - c_1 \dot{x}_m \text{ for } m = 3, \dots, 6.$$

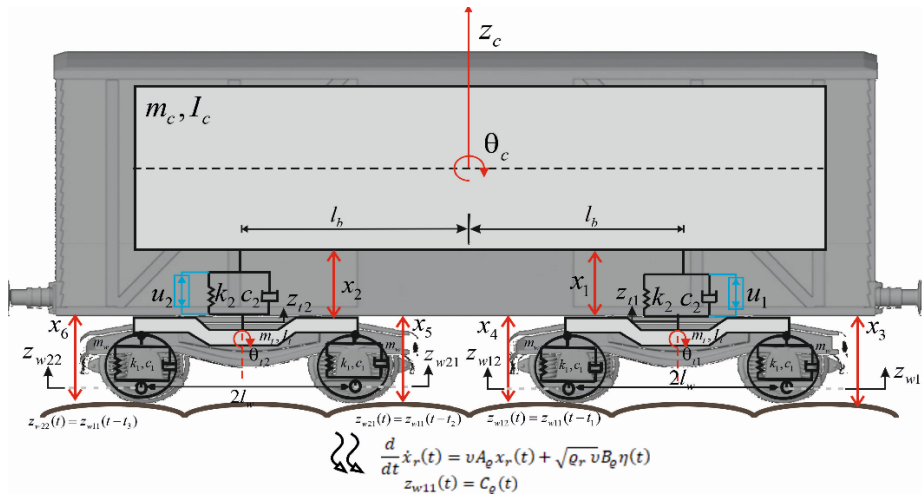

Figure 1. 6 DOF model for a freight wagon with Y25 bogie

The dynamical model can be obtained by using Newton's Laws as in [15-16]. Hence, the state vector $x = [x_1 \ x_2 \ x_3 \ x_4 \ x_5 \ x_6]^T$, the rail input $z_w = [z_{w11} \ z_{w12} \ z_{w21} \ z_{w22}]^T$, and the control input $u = [u_1 \ u_2]^T$ can be interrelated as in Equation 1,

$$\dot{x} = Ax + B_1 z_w + B_2 u \quad (1)$$

with the state-space triplet (A, B_1, B_2) . The active control is ensured by equipping actuators across the front and rear secondary suspensions to minimize the primary suspension deflections, the car body heave, and pitch accelerations, without causing large suspension deflections at the secondary suspensions. Then, the regulated output vectors $z_\infty = [F_m \ \ddot{z}_c \ \ddot{\theta}_c]^T$ and $z_2 = [x_1 \ x_2]^T$ can be written in terms of the state-space parameters, respectively as follows:

$$z_\infty = C_\infty x + D_\infty z_w + D_\infty u. \quad (2)$$

$$z_2 = C_2 x. \quad (3)$$

The exploited notation used in the figure is listed in Table 1.

Table 1. Vehicle parameters [4]

Symbol	Description	Value
m_c	Car body mass	30,078 kg
m_t	Bogie mass	1036 kg
m_w	Wheelset mass	712.5 kg
c_1	Primary damping coefficient	2000 Ns/m
k_1	Primary spring stiffness	681,000 kN/m
c_2	Secondary damping coefficient	10,000 Ns/m
k_2	Secondary spring stiffness	25,000 kN/m
I_c	Car body pitch moment of inertia	708,850 kgm ²
I_t	Bogie frame pitch moment of inertia	550 kgm ²
l_b	Half the distance of bogie centers	7.1 m
l_w	Half of the bogie wheelbase	0.9 m
r_w	The rolling radius of the wheel	0.46 m

The vertical vehicle response z_∞ , as can be seen from Equation 2, is primarily a function of vehicle suspension and speed, but is ultimately caused by fluctuations in the rail surface. Accurate vehicle response simulation or an analytical approach to the prediction of ride motions requires the mathematical model of the vehicle to be excited by the irregular rail profile. Traveling on the longitudinal distance $x = vt$ with a constant speed v and no rail jumps happening, will induce random vibrations due to the rail geometry and its surface unevenness. Let's consider the rail profile as a realization of a homogeneous and isotropic random process. Thus, a single autocorrelation function evaluated from any longitudinal track and a single power spectral density function will provide a surface description sufficient for multi-track vehicle response analysis.

Let, $\tilde{z}_{w11}(t) = z_{w11}(vt)$ and define the autocorrelation functions $\mathcal{R}_{\tilde{z}_{w11}}(t)$ and $\mathcal{R}_{z_{w11}}(t)$ with the expected operator $\mathcal{E}\{\dots\}$,

$$\mathcal{R}_{\tilde{z}_{w11}}(t) = \mathcal{E}\{\tilde{z}_{w11}(t)\tilde{z}_{w11}^T(0)\} = \mathcal{R}_{z_{w11}}(vt), \quad (4)$$

and the power spectral density $\mathcal{S}_{\tilde{z}_{w11}}(\omega)$ as the Fourier transform

$$\mathcal{S}_{\tilde{z}_{w11}}(\omega) = \int_{-\infty}^{\infty} \mathcal{R}_{\tilde{z}_{w11}}(t) e^{-j\omega t} dt = \int_{-\infty}^{\infty} \mathcal{R}_{z_{w11}}(vt) e^{-j\omega t} dt. \quad (5)$$

Let's make a change of variable $x = vt$ in Equation 5, then

$$\mathcal{S}_{\tilde{z}_{w11}}(\omega) = \frac{1}{v} \int_{-\infty}^{\infty} \mathcal{R}_{z_{w11}}(x) e^{-j\frac{\omega}{v}x} dx. \quad (6)$$

Equation 6 implies that the power spectral density $\mathcal{S}_{z_{w11}}(\Omega)$, where the spatial frequency $\Omega = \frac{\omega}{v}$ has a unit radian per meter is equal to

$$\mathcal{S}_{z_{w11}}(\Omega) = v \mathcal{S}_{\tilde{z}_{w11}}(\omega)$$

for ω in radians per second. By using the Wiener-Hopf equation $\mathcal{S}_{z_{w11}}(\Omega)$ can be expressed as an output spectrum of a linear time-invariant filter with a transfer function $G_{z_{w11}}(j\Omega)$, driven by a unit intensity white noise as,

$$\mathcal{S}_{z_{w11}}(\Omega) = G_{z_{w11}}(j\Omega) G_{z_{w11}}(-j\Omega)^T. \quad (7)$$

The rational power spectral functions are generously used by Federal Railroad Administration (FRA) to standardize the rail track profiles for varying roughness ρ_r , and allowable speed limits. A list is provided in Table 2 where the track quality is classified from the worst quality with Class I, to the perfectly smooth one with Class VI [18]. To shape the frequency content of the power spectral density functions given by FRA a linear filter approach defined with Equation 7 will be used. Thus, the rational function that models the rail roughness will be the output of a filter $G_{z_{w11}}(j\Omega)$ with the state-space equations,

$$\begin{aligned} \frac{d}{dx} \zeta_r(x) &= A_\rho \zeta_r(x) + \sqrt{\rho_r} B_\rho \eta(x), \\ z_{w11}(x) &= C_\rho \zeta_r(x), \end{aligned} \quad (8)$$

excited by white noise $\eta(x)$ of unit intensity.

Table 2. Vehicle speed limits [18]

Track quality class	ρ_r ($10^{-6}m^{-1}$)	Vehicle speed limit (km/h)
Class-I	0.4868	16
Class-II	0.3387	40
Class-III	0.2328	64
Class-IV	0.1566	96
Class-V	0.1058	129
Class-VI	0.07197	--

The rear wheels $z_{w12}(t), \dots, z_{w22}(t)$ will experience the same rail roughness as $z_{w11}(t)$ but with time delays t_1, t_2 , and t_3 , respectively. For control purposes, the time delays may be represented by rational (Pade) approximations. In this study, a second-order Pade approximation denoted by $\Delta(s)$ is sufficiently accurate. Then,

$$z_w = [z_{w11} \ \Delta \ z_{w11}]^T.$$

By using Equations 1–2, 6–8 the auto-correlation function of $z_{\infty}(t)$ can be written as

$$\mathcal{R}_{z_{\infty}}(0) = \frac{1}{2\pi} \int_{-\infty}^{\infty} T_{z_{\infty}z_w}(j\omega) \begin{bmatrix} G_{\rho} \\ \Delta G_{\rho} \end{bmatrix} \begin{bmatrix} G_{\rho} \\ \Delta G_{\rho} \end{bmatrix}^* T_{z_{\infty}z_w}^*(j\omega) d\omega, \quad (9)$$

where $T_{z_{\infty}z_w}$ denotes the transfer matrix from z_w to $z_{\infty}(t)$, and

$$G_{\rho} = C_{\rho}(j\omega - vA_{\rho})^{-1} \sqrt{\rho_r v} B_{\rho}, \quad (10)$$

teaming up to construct the augmented ‘vehicle-track’ model, from a single input $\eta(t) \mapsto z_{\infty}(t)$:

$$T_{z_{\infty}\eta} = T_{z_{\infty}z_w}(j\omega) \begin{bmatrix} G_{\rho} \\ \Delta G_{\rho} \end{bmatrix}. \quad (11)$$

The square root of the elements in the diagonal of $\mathcal{R}_{z_{\infty}}(0)$ is called the root-mean-square (RMS) value and is used as a measure of performance indicators of the vehicle. Three applicable concepts concerning ride comfort, vehicle speed, and track quality are going to be discussed in the next section:

- (i) Improve passenger performance indicators at current speed and track quality;
- (ii) Enhance the speed at maintained performance indicators with no demand on track quality;
- (iii) Allow lower track quality without compromising the performance indicators and speed.

3. The Effect of the Wagon Speed and Track Quality

In the vehicle context, the accelerations serve as indicators of ride comfort, wheel forces as a measure of rail holding, and suspension travels as indicators of vehicle handling. The RMS values of these performance indicators are directly influenced by the forward speed as derived in Equation 10, so their evaluations on various track qualities should be studied. The wagon is tested on profiles in Table 2, at speeds of 0–150 km/h and the results are presented in Figures 2–4.

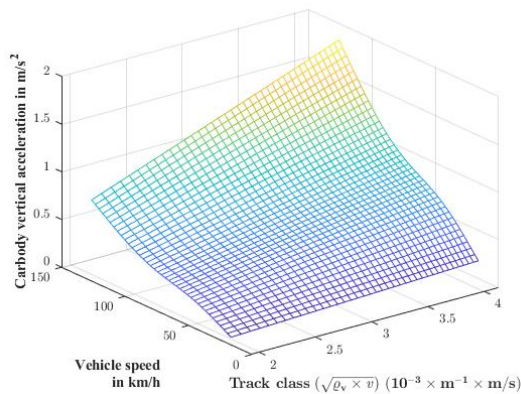

Figure 2a. Effect of vehicle speed and track quality on car body vert. acc.

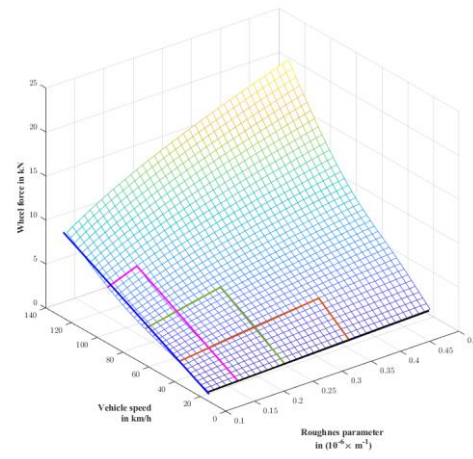

Figure 2b. Effect of vehicle speed and track quality on front wheel-forces

Figures 2a-2b show the trend of decreasing comfort (larger RMS vertical acceleration) with increasing speed, and how the ride comfort changes if a track of given roughness is traversed with different speeds. The levels of comfortable riding can easily be assessed, or how much can the

suspension travels or wheel forces vary so that the ride comfort is still within, for example, 5% of its optimal value can easily be deduced from the figures. In Figure 2b the ride-limiting speeds on different track qualities are shown with horizontal lines while the possible speed regions the vehicle can safely traverse without violating the ride comfort are marked with vertical lines of the corresponding region. For safer driving, the wheel forces should stay inside those regions, since the figures indicate that at higher speeds or on uneven tracks than those outside of the regions, the vehicle may experience severe excitations, which in turn may result in instabilities or the derailment of the wagon. Meanwhile, by inspecting Figures 2-4 together, we can see that on smoother profiles, Class IV-VI for example, the suspension system will be exposed to less damping and can go soft if stayed within the allowable regions. Otherwise, a trend towards increasing stiffness may be observable, since more wheel movements will need increased suspension travel to prevent hitting a bump and rebound stops. From Figure 3 we can observe that when the wagon travels over a track consisting of different roughness sections with a speed setting for a particular one (going in the X direction), a challenging effect on the wheel forces ‘more than two times’ may occur, forcing the ride comfort along with to disrupt as shown in Figure 2a.

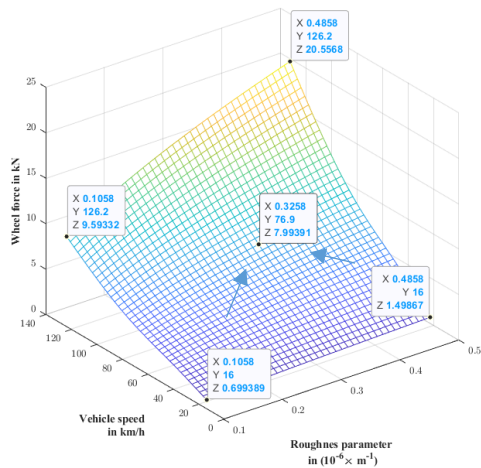

Figure 3. Effect of vehicle speed and track quality on rear wheel-forces

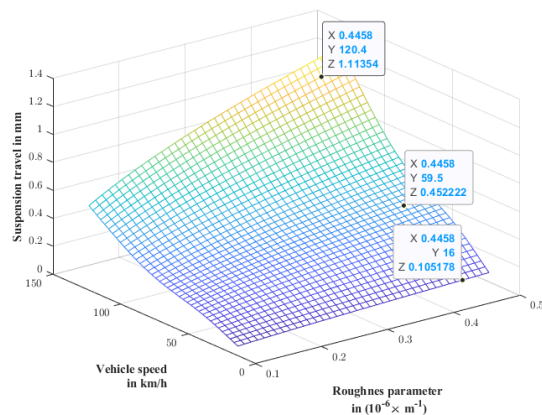

Figure 4. Effect of vehicle speed and track quality on susp. def.

If the vehicle traverses a particular rail profile with constantly increasing speed (going in the Y direction), there will be a firm increment in the wheel forces though not as harsh as in the previous one. Finally, if the wagon travels on constantly smoothing or worsening track sections with increasing speed (going in the arrow direction), the rail holding will be drastic in the latter case. Though an uninterrupted wheel-rail contact may still be ensured, the dynamic wheel load will challenge the static one. This may lead to unreliable circumstances or may cause higher ground vibrations if the freight wagon is driven over a common rail line since the wheel forces for a freight wagon are much larger than the passenger trains'. Let's take it further and investigate the instance if the vehicle traverses a particular rail profile at a prespecified speed with a suspension setting optimized for a different speed (going in the Y direction) as in Figure 4. It is shown that the suspension travel that should be kept below a maximum allowable level will increase sharply, bringing a potential for structural damage and a dramatic deterioration of ride comfort. The vibrations evidently get worse on Class V. Though speed tuning during traveling might be possible by constantly alternating between acceleration, deceleration, constant speed, and stop, the track quality may instantaneously change due to geographical unevenness or degenerated surfaces. So, precise and reasonable speed profiles as in Figures 2-4, obeying the equation of motion concerning the physical constraints of the wagon and the railway geometries, are strongly suggested to be generated from the start station to the end station. However, remains two questions that have to be addressed when determining the optimal “speed-roughness” settings.

- To what extent do the optimal settings vary for a track of given roughness if traversed at different speeds and what levels of ride comfort can be achieved in these cases?’
- If the wagon travels over tracks of different roughness at a specified speed, is there a significant difference in the performance indicators on the same road conditions?’

The next section will seek out for answers to these questions by stepping in from performance analysis of passive suspensions to controller synthesis.

4. \mathcal{H}_∞ Controller Design

The speed of the wagon and the track quality depend on many factors and vary during traveling. In this subsection, assuming that v and q_r take values in some prescribed intervals $[\alpha_i, \beta_i]$, we will design a multi-objective controller with guaranteed performance in this interval. Let $T_{z_\infty \eta}$ in Equation 11 be represented by the following linear time-invariant state-space realization:

$$\begin{pmatrix} \dot{\hat{x}}(t) \\ z_\infty(t) \\ z_2(t) \end{pmatrix} = \begin{pmatrix} \hat{A} & \hat{B}_1 & \hat{B}_2 \\ \hat{C}_\infty & \hat{D}_{\infty 1} & \hat{D}_{\infty 2} \\ \hat{C}_2 & 0 & 0 \end{pmatrix} \begin{pmatrix} \hat{x}(t) \\ \eta(t) \\ u(t) \end{pmatrix} \quad (12)$$

Polytopic representation is one of the most general ways to describe without any conservatism the physical parameter uncertainty and the matrices \hat{A} and \hat{B}_1 can be separated into,

$$\hat{A} = \hat{A}_0 + q_1 \hat{A}_1 + q_2 \hat{A}_2 \quad \text{and} \quad \hat{B}_1 = \hat{B}_{10} + q_1 \hat{B}_{11} + q_2 \hat{B}_{12},$$

where $(\hat{A}_0, [\hat{B}_{10} \ \hat{B}_{20}], [\hat{C}_\infty \ \hat{C}_2]^T, [\hat{D}_{\infty 1} \ \hat{D}_{\infty 2}; 0 \ 0])$, $(\hat{A}_1, [\hat{B}_{11} \ 0], [0 \ 0]^T, [0 \ 0; 0 \ 0])$, $(\hat{A}_2, [\hat{B}_{20} \ 0], [0 \ 0]^T, [0 \ 0; 0 \ 0])$ are the state-space realizations of the first, second and third vertex of the polytope and $q_1 = \sqrt{q_r v}$, $q_2 = v$. Then, the objective is to design a state-feedback controller shown in Figure 5,

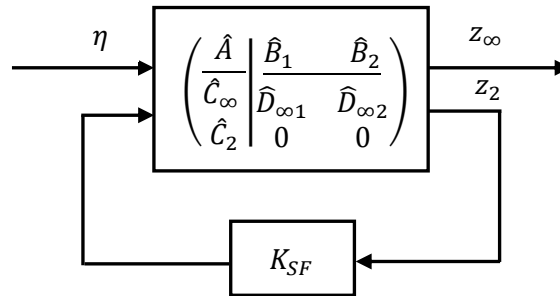

Figure 5. \mathcal{H}_∞ control scheme

by

$$u = K_{SF} x,$$

which provides internal stability of the resulting closed-loop system and minimizes the \mathcal{L}_∞ norm for $\mathfrak{S} > 0$,

$$\begin{aligned} \min_{K_{SF} \in RH_\infty} \quad & \|\mathfrak{S} T_{z_\infty \eta}\|_\infty \\ \text{s. t.} \quad & \|T_{z_2 \eta}\|_2 < \gamma, \quad \gamma > 0, \end{aligned} \quad (13)$$

subject to a permissible travel range of suspensions γ .

Here, RH_∞ denotes the set of real-rational transfer functions which are stable and proper and the weight \mathfrak{S} regulates the trade-off between the vertical acceleration–primary suspension deflection. By the scaling of \mathfrak{S} and γ it is possible to pursue the progress of the solution for certain benchmark values or to force it to satisfy the design requirements. Linear matrix inequalities will be employed to solve the problem in Equation 13 and MATLAB’s LMI Control Toolbox [19] will be used to implement the optimization algorithm. Since knowing the exact value of the roughness parameter increases the controller performance, let’s fix $q_r = 0.1058 \times 10^{-6}$ and confine the speed a freight wagon can ever make on track Class V, between its upper and lower limits. Thus, $q_1 \in [0.0015, 0.0020]$, $q_2 \in [4.44, 35.83]$ m/s can be chosen for the polytopic uncertainty and $\gamma = 8.32 \times 10^{-4}$ m is selected as it is the \mathcal{L}_2 norm of passive suspension deflections. The results are indicated in Figures 6-8 for the car body acceleration, and primary and secondary suspension deflections, respectively. The vertical ride comfort improvements are achieved by incorporating the \mathcal{H}_∞ controller into the vehicle while keeping the suspension deflections at a bay. It is seen that the trend of decreasing comfort with increasing speed as earlier pointed out in Figures 2-4, is very well

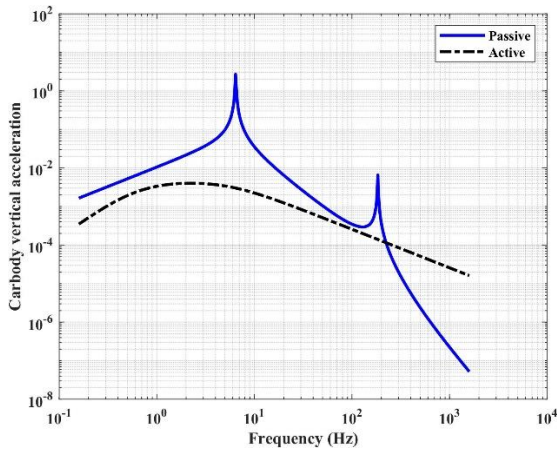

Figure 6. Car body ver. acc. frequency response for track class V

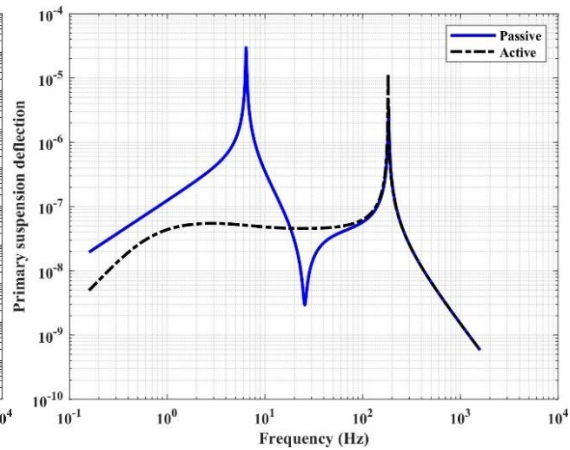

Figure 7. Primary susp. def. frequency response for track class V

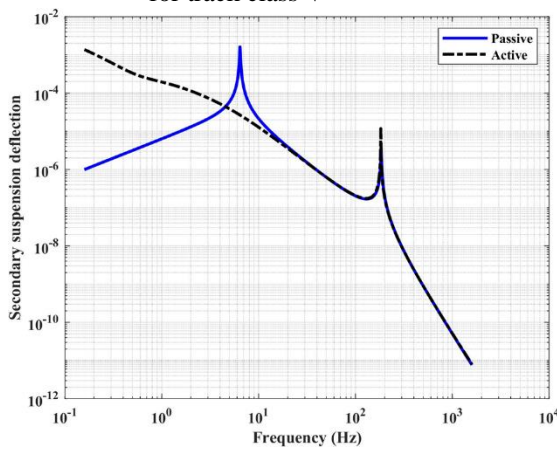

Figure 8. Secondary susp. def. frequency response for track class V

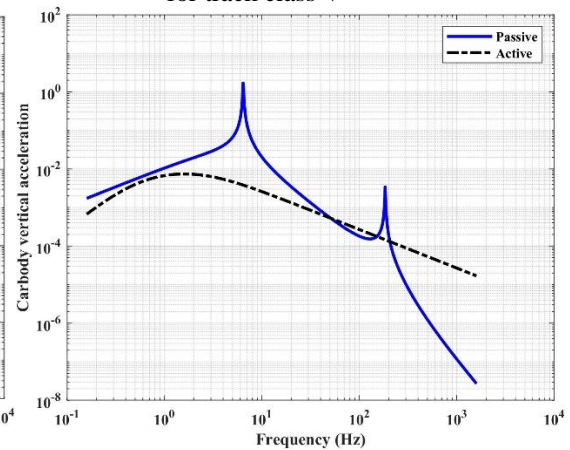

Figure 9. Car body ver. acc. frequency response for track class III

tolerated with this \mathcal{H}_∞ controller. Additionally, all improvements are attained at the low-frequency range which is more sensitive to bending deformations of the freight wagon, showing almost 44% reduction of vertical acceleration compared to the passive one. Let’s assess the performance of this same controller on a worse track quality, for example, Class III. Figure 9 shows that the vibration on ride comfort is still successfully suppressed with a controller which is

designed for smoother riding conditions, and the same conclusion can be extended to all performance indicators but the figures will be omitted for the sake of brevity.

The investigation concerning the ride comfort that could be achieved if the active suspension is designed for various tracks traversed at a specified speed can be expanded by setting $q_1 \in [0.0012, 0.0022]$, and $q_2 = 13.88$. By utilizing the \mathcal{H}_∞ controller at a speed of 50 km/h, the wagon will have the performance evaluations at Figures 10-12. Studying these plots affirms that lesser body movements will result in smaller car body vertical acceleration, but more wheel movements, which will need increased suspension deflection to prevent hitting irregularities on the track. Even though the track quality decreases, severe wheel movements will not occur, since the controller will provide enough damping. Good handling requires a stiff suspension, whereas a soft suspension provides a better ride comfort. This remarkable compromised solution presented in the figures is only possible because of the polytopic formulation of the optimization problem in Equation 13. The last part of the investigation concerned the ride comfort that could be achieved if the optimized controller setting obtained for various tracks is used at this particular profile (Class III) of an allowable speed limit of 50 km/h. Figure 13 shows that the controller is quite capable of minimizing the vertical accelerations while maintaining good vehicle handling and rail holding qualities, skipping the plots of latter for space considerations. The results are verified with time-domain simulations in Figure 14. The controller's performance is very impressive both frequency and time domain.

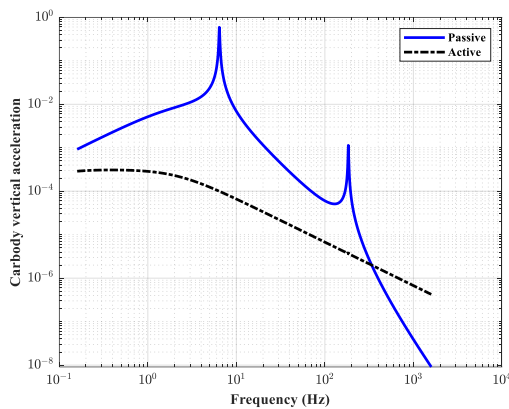

Figure 10. Car body ver. acc. frequency response at 50 km/h speed

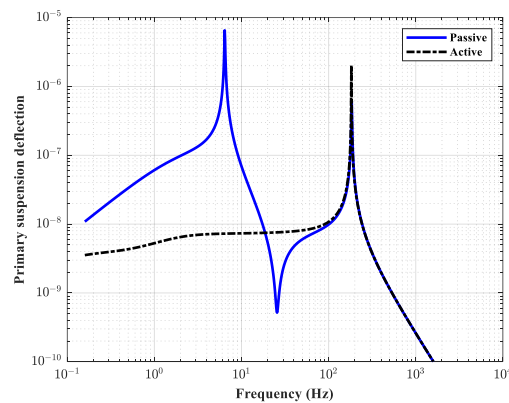

Figure 11. Primary susp. frequency response at 50 km/h speed

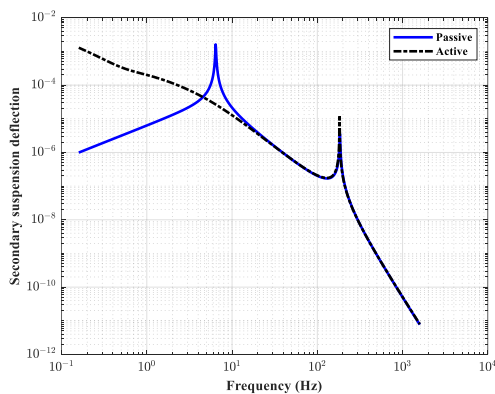

Figure 12. Secondary susp. frequency response at 50 km/h speed

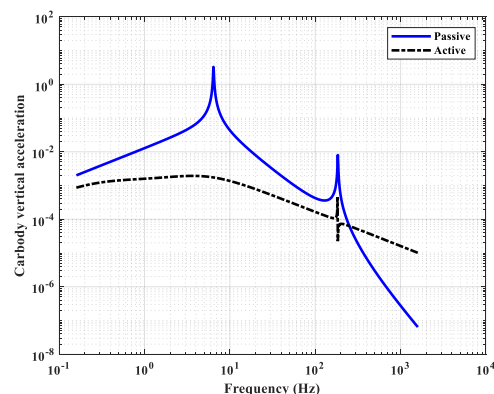

Figure 13. Car body ver. acc. frequency response on track class III

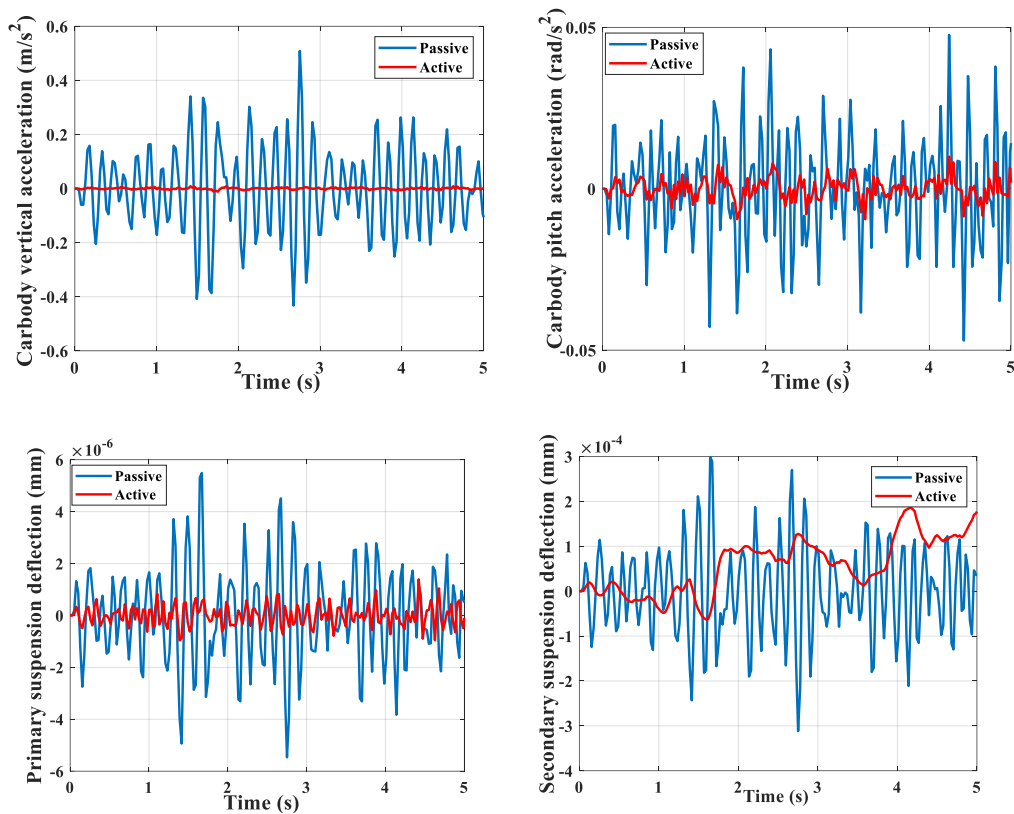

Figure 14. Time-domain responses on track class III at 50km/h

4. Conclusion

In this paper, a half-car model of a freight wagon in combination with linear-filter modelling of the track roughness has been used to investigate the influence of the speed and track quality on the primary suspension travels, car body accelerations, and suspension deflections. It is shown that the dynamic forces induced by the interaction between the wheel and railroad, lead to a deterioration along the tracks and consequently produce ride discomfort and poor rail holding. Since, the track roughness is a determinant factor for riding comfort and railroad infrastructure, the classification method proposed by FRA that standardizes the railroad track quality has been used for evaluating the overall performance of vehicle track interaction. Though the rational power spectral density functions defined in the report have been easily incorporated into the freight wagon dynamics, the simulation studies have shown that the assessment of the vehicle performance is highly dependent on the track quality and vehicle speed. The findings of this work draw attention to the maintenance of the track whose main purpose is to provide a stable, safe platform for the freight wagons to operate at various speeds and are applicable to any railway network. Reducing the maintenance cost and enhancing the transport quality can be achieved by designing active controllers that improve the running behaviour of the vehicle. In this work, the ride comfort performance is optimized by designing an active controller for the half-car wagon model. The robust \mathcal{H}_∞ control was synthesized by solving a constrained optimization problem. The analytical results were given for the aspects of frequency-domain, time-domain and polytopic uncertainties. It is further shown that the objective function to be minimized can correspondingly be modified to improve the ride quality on different sets of speeds and track conditions. The numerical simulations performed in MATLAB software show that the proposed control algorithm in this study is decent and effective. In this manner, this study provides a helpful reference for the control of freight wagons by using other control algorithms. Although not reported in this paper, the robust controller synthesized for a suspension system with polytopic uncertainties can offer

an advantage by also attenuating the flexible modes of the car body vibrations. When the rail vehicle is traveling on changing track conditions, especially at high speeds, it is known that the first bending mode frequently becomes a problem. This mode has a frequency around 8-12 Hz, and in order to improve the riding quality, it needs to be suppressed. The numerical studies in this study showed that the polytopic controller designed is highly capable of handling the vibrations happening in this frequency region. The topic warrants further studies, but this work is going to make a foundation for the elaboration techniques to make stronger theoretical connections. Furthermore, the recent car body shells are built to be more lightweight, conducting some lower modes of the flexural vibrations to occur in the lower frequency regions where they can overlap with rigid modes and become more prominent. At the same time, the proposed design here can offer a solution to suppress both the flexible and rigid modes simultaneously and effectively by the active suspension design. The study of achievable performance in the lateral direction for the wagon active suspensions remains another future work in a multi-input/multi-output framework.

References

- [1] A. Orvnäs, S. Stichel, and R. Persson, "Ride comfort improvements in a high-speed train with active secondary suspension," *J. Mech. Syst. Transp. Logist. (JSME)*, vol. 3, no. 1, pp. 206–215, 2010
- [2] X. Lei, *High speed railway track dynamics: Models, algorithms and applications*. Singapore: Springer, 2017
- [3] G. Kouroussis, D.P. Connolly and O. Verlinden, "Railway induced ground vibrations: A review of vehicle effects," *International Journal of Rail Transportation*, vol. 2, no. 2, pp. 69-110, 2014
- [4] E. Bernal, M. Spiriyagin, and C. Cole, "Wheel flat detectability for Y25 railway freight wagon using vehicle component acceleration signals," *Vehicle System Dynamics*, vol. 58, no. 12, pp. 1893-1913, 2020
- [5] M. Buonsanti and G. Leonardi, "Dynamic modelling of freight wagon with modified bogies," *European Journal of Scientific Research*, vol. 86, pp. 274- 282, 2012
- [6] P. A. Jönsson, "Dynamic vehicle-track interaction of European standard freight wagons with link suspension" Ph.D. dissertation, Dept. Aeron. and Veh. Eng., Royal Institute of Technology, Stockholm, 2007
- [7] C. Jones and J. Block, "Prediction of ground vibration from freight trains," *Journal of Sound and Vibration*, vol. 193, no. 1, pp. 205–213, 1996
- [8] *Guide to evaluation of human exposure to vibration in buildings (1Hz-80Hz)*, BS 6472-1, British Standards Institution, 2008
- [9] *Mechanical vibration-ground-borne noise and vibration arising from rail systems - Part 1: General guidance*, BS ISO 14837-1, British Standards Institution, 2005
- [10] M. Buonsanti, and G. Leonardi, (2012). "Dynamic modelling of freight wagon with modified bogies," *Eurpoean Journal of Scientific Research*, vol. 86, pp. 274–282, 2012
- [11] F. Hassan, A.C. Zolotas, and R.M. Margetts, "Optimised PID control for tilting trains," *Syst. Sci. Control Eng.*, vol. 5, no. 1, pp. 25–41, 2017
- [12] R. Zhou, A Zolotas, and R. Goodall R, "Integrated tilt with active lateral secondary suspension control for high speed railway vehicles," *Mechatronics*, vol. 21, no. 6, pp. 1108–1122, 2011
- [13] E.F. Colombo, E. Di Gialleonardo, A. Facchinetti and S. Bruni, "Active carbody roll control in railway vehicles using hydraulic actuation," *Control Engineering Practice*, vol. 31, pp. 24–34, 2014
- [14] R. Zhou, A. Zolotas, and R. Goodall, "Robust system state estimation for active suspension control in high-speed tilting trains," *Vehicle System Dynamics*, vol. 52, pp. 355–369, 2014
- [15] A. Soyiç Leblebici and S. Türkay, "Track modelling and control of a railway vehicle," *7th IFAC Symposium on Mechatronic Systems*, 2016, pp. 274–281
- [16] A. Soyiç Leblebici and S. Türkay "Hybrid semi-active controller design for a high speed railway vehicle," *Turkish National Conference on Automatic Control (TOK2018)*, Kayseri, Turkey, 2018, pp. 528–533
- [17] P. Apkarian, H. D. Tuan, and J. Bernussou, "Continuous-time analysis, eigenstructure assignment, and H_2 synthesis with enhanced linear matrix inequalities (LMI) characterizations," *IEEE Transactions on Automatic Control*, vol. 46, no. 12, pp. 1941-1946, 2001

- [18] A. Hamid, K. Rasmussen, M. Baluja, and T. Yang, *Analytical Descriptions of Track Geometry Variations Volume I*, National Technical Information Service, U.S. Department of Commerce, Springfield, 1983
- [19] P. Gahinet, A. Nemirovski, A. Laub and M. Chilali, *LMI control toolbox for use with MATLAB*. The Mathworks Inc., 1995

Resume



Aslı SOYIÇ LEBLEBİCİ

Aslı Soyıç Leblebici received her B.Sc. degree from Anadolu University, Eskisehir, Turkey, in 2007. She received her M.Sc. degree from Anadolu University, Eskisehir, Turkey, in 2009. She is currently working as lecturer at Electronics and Automation Department of Eskisehir Osmangazi University, Eskisehir, Turkey. Her research interests include mechatronic systems, railway vehicle dynamics, optimization and control systems.

E-mail: aleblebici@ogu.edu.tr



Semiha TÜRKAY

Semiha Türkay received her PhD degree in Electrical and Electronics Engineering at the Anadolu University, Turkey. She received a research scholarship award in 2008 from the Deutscher Akademischer Austauschdienst (DAAD) and visited Munich Technical University as a PhD researcher. She is currently Assistant Professor at the Department of Electrical and Electronics Engineering, Anadolu University. Her research interests include random vibrations, estimation, system identification and active suspension control for automotive and railway vehicles.

E-mail: semihaturkay@eskisehir.edu.tr

Ethics Statement:

Authors confirm that the article is original, there is no plagiarism issue.