

Research Article

Performances Investigation of the Eco-friendly Refrigerant R131I used as Working Fluid in the Ejector-Expansion Refrigeration Cycle

¹Y.Maalem , ^{2*}Y.Tamene , ³H.Madani 

^{1,2,3} Laboratory of Studies of Industrial Energy Systems (LESEI), Department of Mechanical Engineering, Faculty of Technology, University of Batna 2, 05000 Batna, Algeria
E-mails: ¹y.maalem@univ-batna2.dz, ^{2*}y.tamene@univ-batna2.dz, ³h.madani@univ-batna2.dz

Received 12 March 2023, Revised 27 May 2023, Accepted 5 July 2023

Abstract

Knowing that from 2030 refrigerants used in refrigerating engineering should have a global warming potential (GWP) of less than 150. Searching for eco-friendly refrigerants with good performance and minimal environmental impact to substitute conventional working fluids such as R134a (GWP=1430) represents a great challenge for researchers. The present research aims to investigate and compare the performances of the eco-friendly refrigerant R131I (Zero GWP) used as a possible new working fluid in the ejector-expansion refrigeration cycle (EERC) with the commonly used R134a which has good performances but a high GWP. To reach this objective, a numerical program was developed using MATLAB software to evaluate the coefficient of performance (COP), the entrainment ratio (μ), the exergy destruction and the exergy efficiency for both refrigerants. Furthermore, the effect of the diffuser efficiency of the ejector on the COP and the compressor work was explored. Furthermore, the effect of the diffuser efficiency of the ejector on the COP, and the compressor work were explored. The simulation was realized for T_c selected between 30 and 55 °C and T_e ranging between -10 and 10 °C. Results proved that the use of R131I as a working fluid in the EERC system exhibited a higher COP, μ , and exergy efficiency, as well as lower exergy destruction compared with R134a under the same operating temperatures. On another hand, the energetic analysis revealed that as T_c increases the COP and μ decrease. However, as T_e varies from -10 and 10 °C, the COP and μ increase. Regarding exergy analysis, it should be noted that both exergy destruction and exergy efficiency are sensitively influenced by T_c more than T_e . Overall, the study confirms that R131I could be a suitable substitute for the phase-out R134a in terms of performance and environmental protection.

Keywords: R131I working fluid; zero GWP; ejector; coefficient of performance; entrainment ratio; exergy efficiency.

1. Introduction

The search for alternative refrigerants to substitute the traditional refrigerants which have a high global warming potential (GWP) is based on two major prerogatives: having good performances and a low environmental impact. According to the restrictive regulations by the international agreements Montreal (1987) and the Kyoto (1997) protocols, and the European (F-gas) regulation, the fluoride substances: chlorofluorocarbons (CFCs), hydrochlorofluorocarbons (HCFCs) and hydrofluorocarbons (HFCs) widely used in the applications of the thermodynamic machines such as heat pump, air-conditioning and refrigeration systems, would be phased out because of their great impact on the environment and their contribution to the atmospheric greenhouse [1,2]. The Paris climate convention adopted on 4 November 2016, makes the research for sustainable refrigerants that can answer the environmental concern and the demand for cooling efficiency a pressing priority.

Currently, seeking alternative work fluids to meet environmental requirements, as well as more efficient refrigeration systems has become an important research topic in refrigeration engineering. Furthermore, the development of new technologies for performance enhancement of the conventional mechanical vapor compression refrigeration

cycle (CMVCRC) by diverse cycle changes has acquired a particular interest newly. Accordingly, several modifications have been proposed in the mechanical single-stage vapor compression systems to improve their energy efficiency and reduce power consumption with different working fluids.

One of the most recent effective ways that have noticeable benefits is the ejector expansion technology. The use of an ejector apparatus as the expansion valve instead of a classical expansion valve reduces throttling mechanism losses by recovering expansion work, additionally, its design and build are inexpensive and it has low maintenance requirements [3]. An ejector expansion device, which consists of a motive nozzle, suction nozzle, mixing section and diffuser is able of converting the kinetic energy of the expansion operation to pressure flow work, increasing compressor absorption pressure to a level higher than that in the evaporator and consequently reducing the power consumption of the compressor and improving the performance of the mechanical refrigeration system. With the introduction of the technology of ejector expansion in the cooling systems to improve their cooling efficiency for the first time by Kornhauser in 1990 [4], studies in this area have seen a growing trend, where many numbers of academic researchers have performed investigations both numerically

and experimentally with different working fluids[5]. It is also found from the literature reviews that the preceding ejector-expansion refrigeration cycle (EERC) works are usually related to pure fluid: CFCs [6,7], HCFCs [7], HFCs [7-9], natural fluids such as carbon dioxide (R744) [10-12] and hydrocarbon (Propane (R290)[13], Butane (R600), Propane (R290), Isobutane (R600a) and Propylene (R1270) [14] or zeotropic blends like (R245fa/R134a) [15], (R290/R170) [16], R410A [17],(R134a/R143a) [18] and (R290/R600a) [19].

Due to the increased environmental consciousness, the traditional refrigerants CFCs, HCFCs and HFCs would be phased out and the hydrocarbons have potential safety hazards in applications owing to their flammable and explosive properties. Furthermore, although R744 fluid is ecofriendly, it undergoes high running pressure and relatively low performance, which results in a ponderous and expensive refrigeration machine. In addition, the zeotropic blends exhibit various problems in the cooling cycles (CMVCRC, EERC) due to their behavior compared to the single-fluids such as mole fraction difference of the vapor to liquid and temperature variation during constant pressure phase change, they present also a low coefficient of performance[20-22,3], this can be induced by the delay of the liquid-vapor equilibria such as overheating or undercooling, which results from the temperature change during the cooling process (temperature glides) [20]. The dilemma for the refrigeration industry is finding a new working fluid in the EERC system that can meet the requirements of environmental properties, safety and high performance at the same time.

On the other hand, there is recently a renewed interest in the use of Trifluoriodomethane (R131I) refrigerant as the working fluid in the thermodynamic systems of the production units [23,24], however studies on the EERC system using R131I as working fluid in the field of refrigeration were not found in the literature. While this fluid has excellent thermo-physical properties [25] like R134a, good safety, and negligible environmental impact [Zero Ozone Depletion Potential (ODP=0), Zero Global Warming Potential (GWP=0)] [26], so it can be considered as an alternative refrigerant. Considering the increasing restrictions imposed by the international Montreal and Kyoto protocols, the refrigerant can be selected as a possible new working fluid in the EERC system and can be recommended as a good candidate for replacing the above working fluids and especially the phase-out R134a (HFC), which is widely used in EERC system, due to its good performances in the EERC system, unfortunately, it has high global warming potential (GWP=1430).





As far as the authors are aware, no previous study has found an appropriate pure substance with high performances (such as COP) in the EERC system to replace R134a and can meet the requirements of environmental properties, thermo-physical properties and high performance at the same time. This study is conducted for this purpose.

The eco-friendly R131I, which has good characteristics in terms of thermo-physical properties and environmental protection, has not been used before in the EERC system, and there is no published literature about comparison between the thermodynamic performances of R131I and R134a at present. Therefore, the present study aims to investigate theoretically the performance of the EERC system in terms of coefficient of performance (COP), entrainment ratio (μ), exergy destruction and exergy

efficiency using the eco-friendly R131I refrigerant as a substitute to the traditional R134a fluid.

The fundamental environmental and thermodynamic properties of the investigated refrigerants are shown in Table 1 [26-28].

Table 1. Physical and environmental properties of investigated refrigerants.

| Refrigerants | R131I | R134a |
|--------------------------|---|---|
| Cas N° | 2314-97-8 | 811-97-2 |
| Molecular formula | CF ₃ I | C ₂ H ₂ F ₄ |
| Molecular structure |  |  |
| Chemical structure |  |  |
| Molar mass (kg/kmol) | 195.91 | 102.03 |
| Critical temperature (K) | 396.44 | 374.21 |
| Critical pressure (MPa) | 3.9530 | 4.0593 |
| Normal boiling point (K) | 251.3 | 247.08 |
| GWP | 0 | 1430 |
| ODP | 0 | 0 |

The thermodynamic properties of the working fluids greatly affect the cycle performances. So, to investigate an alternative refrigerant that gives suitable performances similar to the existing refrigerant R134a in the EERC system, the thermodynamic and environmental properties should be taken into account. As illustrated in Table 1, the values indicate that R131I has similar thermodynamic properties to that of R134a such as the normal boiling point and the critical pressure. The high normal boiling point has an effect on the latent heat of vaporization whereas the high normal boiling point makes a greater latent heat of vaporization and as a result, the refrigerating effect increases. About the critical temperature, the R131I has a critical temperature much higher than that of R134a, which makes a greater heat transfer. In terms of environmental friendliness, environmental properties are discussed in the paragraphs above. In overall, the working fluid R131I has good thermodynamic and environmental properties.

To reach the objectives of this study, a numerical model based on the energetic and exergetic methods of the EERC system is developed and validated to compare the performances of the eco-friendly refrigerant R131I with the usually used fluid R134a in the EERC system under the same operating parameters. The thermodynamic performances studied include the coefficient of performance (COP), the entrainment ratio (μ), the exergy destruction, and the exergy efficiency. Furthermore, the influences of evaporator and condenser temperatures on the EERC system performances and the effect of the isentropic efficiency of the diffuser section on the COP and the compressor work are also examined and discussed.

2. Description of EERC System

A general illustration of the configuration (Figure 1(a)) and the corresponding pressure-enthalpy (P-h) diagram (Figure 1(b)) of the EERC system is presented in Figure 1.

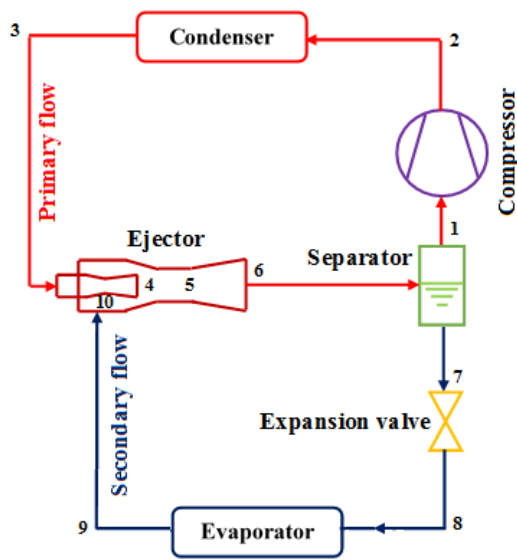

(a)

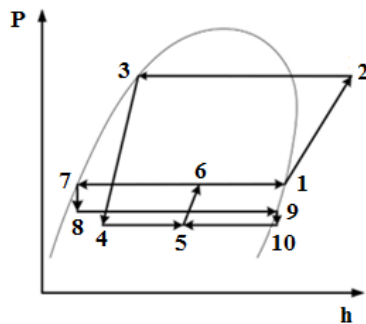

(b)

Figure 1. Configuration (a) and (P-h) diagram (b) of the (EERC) system [29].

The studied system includes six components that are: a compressor, a condenser, an ejector, an evaporator, a throttle valve and a liquid-vapor separator.

The processes of the EERC system can be described as follows: the working fluid in the form of saturated vapor enters the compressor at pressure P_1 (state 1) where it is compressed to high pressure up to pressure P_2 (1→2). The refrigerant in the superheated state (state 2) thus obtained is cooled in the condenser to the temperature corresponding to state 3 (2→3). This constitutes the primary flow (primary fluid) which enters the primary nozzle of the ejector expansion device; and then undergoes an expansion in this nozzle (3→4). At the outlet (state 4), the primary fluid (motive flow) drives the secondary fluid at lower pressure from the evaporator (state 10). Then the primary and secondary streams mix in the mixing section (state 5). The mixed flow at the end of the mixing section at state 5 enters the diffuser section where its velocity drops and pressure increases. On leaving the ejector (state 6), the mixture goes to a separator which divides the two phases (liquid-vapor) of the mixture. At last, the saturated vapor in state 1 is sucked by the compressor while the saturated liquid in state 7 passes through an expansion valve (7→8) before entering the evaporator to produce cold (8→9) and completes the cycle.

3. System Modeling and Assumptions

3.1 Assumptions

For the sake of simplification of the thermodynamic analysis of the EERC system, the following assumptions were made [30,31]:

- The heat loss from the ejector expansion device, condenser, compressor, separator, evaporator and expansion is negligible;
- The flow inside the ejector is one-dimensional and homogeneous;
- The velocities of the refrigerant are negligible at the inlets and outlet of the ejector;
- Mixing operation of the primary and secondary fluids in the ejector device occurs at constant pressure ($P = \text{constant}$);
- The ejector component efficiencies (η_{mn} , η_{sn} , η_{ms} and η_d) keep constant;
- The working operation in the ejector complies with the conservations of mass, momentum and energy;
- Pressure drops in piping, heat exchangers and separator are neglected;
- The refrigerant leaving the condenser, the evaporator and the separator outlet is saturated;
- The compressor has a given specified isentropic efficiency;
- Flow across the expansion valve is isenthalpic ($h = \text{constant}$).

3.2 Numerical Tools and Theoretical Analysis of EERC

3.2.1 Ejector Analysis Model

The ejector expansion device plays an important role in the EERC system where the latter is strongly dependent on the performance of this device. So the prediction of the ejector performance is very important for the refrigeration system behavior thermodynamic modelling.

Presently, the thermodynamic studies for ejector simulation are fundamentally categorized into two models: the constant-area model and the constant mixing pressure model. Several academic studies in the open literature showed that the constant-pressure mixing model gives better results than the constant-area model [5,32-34]. So, in the present study, the constant-pressure mixing model was employed (Figure 2) to conduct performance analysis.

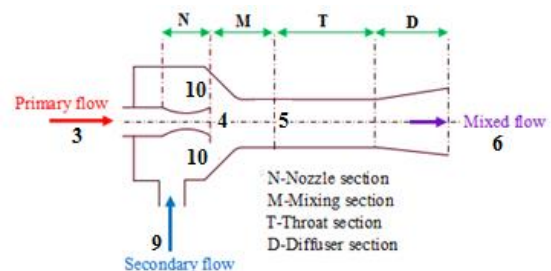

Figure 2. Configuration of constant-pressure mixing ejector.

The entrainment ratio (μ) of the ejector is the key parameter to assess its performance, which is defined as the ratio between the mass flow of refrigerant of the secondary (m_9) and the primary (m_3) leaving from the evaporator and the condenser respectively in the ejector.

It is given as [30-31]:

$$\mu = \frac{m_9}{m_3} \quad (1)$$

Using the mentioned assumptions previously, for thermodynamic modeling of the ejector device the procedure presented by Li et al [30] and Sarkar [31] was followed, and the states of each point of this equipment were calculated using the principle of conservation of mass, momentum and energy.

The modeling begins by determining the states parameters of the primary and secondary flows leaving from the condenser and evaporator respectively to the ejector.

Based on the above analysis, the system equations for ejector can be formulated as follows:

For the motive nozzle outlet:

$$p_4 = p_9 - \delta p \quad (2)$$

$$h_{4,is} = p(p_4, s_3) \quad (3)$$

$$h_4 = h_3 - \eta_{mn}(h_3 - h_{4,is}) \quad (4)$$

$$u_4 = \sqrt{2(h_3 - h_4)} \quad (5)$$

At the suction nozzle outlet, the following equations can be applied:

$$p_{10} = p_4 \quad (6)$$

$$h_{10,is} = p(p_4, s_9) \quad (7)$$

$$h_{10} = h_9 - \eta_{sn}(h_9 - h_{10,is}) \quad (8)$$

$$u_{10} = \sqrt{2(h_9 - h_{10})} \quad (9)$$

For the mixing section:

At the ejector mixing chamber, the mixing process is done at a constant pressure.

Applying the momentum and energy conservations on the mixing chamber would result relations for its exit velocity and enthalpy.

$$p_5 = p_{10} \quad (10)$$

$$u_5 = \sqrt{\eta_{ms} \left(\frac{1}{(1+\mu)} u_4^2 + \frac{\mu}{(1+\mu)} u_{10}^2 \right)} \quad (11)$$

$$h_5 = \frac{1}{(1+\mu)} \left(h_4 + \frac{u_4^2}{2} \right) + \frac{\mu}{(1+\mu)} \left(h_{10} + \frac{u_{10}^2}{2} \right) - \frac{u_5^2}{2} \quad (12)$$

$$s_5 = s(h_5, p_5) \quad (13)$$

For the diffuser outlet, it can be written:

$$h_6 = h_5 + \frac{u_5^2}{2} \quad (14)$$

$$h_{6,is} = h_5 + \eta_d(h_6 - h_5) \quad (15)$$

$$p_6 = p(h_{6,is}, s_5) \quad (16)$$

$$x_6 = x(h_6, p_6) \quad (17)$$

To verify the preliminary input value for the entrainment ratio (μ), the following relationship of the quality (x_6) outlet must be satisfied:

$$x_6' = \frac{1}{1+\mu} \quad (18)$$

3.2.2 Energy Analysis Model

The energy balance equations for system components are established as follows [30]:

The specific cooling (q_{evap}) of the EERC is expressed as:

$$q_{evap} = \frac{\mu(h_9 - h_8)}{1+\mu} \quad (19)$$

The compressor work (w_{comp}) can be expressed as:

$$w_{comp} = \frac{(h_2 - h_1)}{1+\mu} \quad (20)$$

With :

$$h_2 = h_1 + \frac{h_{2,is} - h_1}{\eta_{comp}} \quad (21)$$

Where η_{comp} is the isentropic efficiency of the compressor, which is closely related to the compression ratio, given as [35]:

$$\eta_{comp} = 0.874 - 0.0135\pi \quad (22)$$

The thermodynamic performance EERC system is evaluated by its coefficient of performance, which reflects the cycle performance and is the major criterion for selecting a new refrigerant as a substitute.

The coefficient of performance is defined as the ratio of the specific cooling to the consumption of compressor work (specific work):

$$COP = \frac{q_{evap}}{w_{comp}} \quad (23)$$

Then, the improvements in COP of the EERC over the conventional mechanical cycle (basic cycle) are determined using the following equation:

$$COP_{imp} = \frac{COP - COP_{BC}}{COP_{BC}} \quad (24)$$

3.3.3 Exergy Analysis Model

For the EERC system, exergy analysis enables the evaluation of the contribution of the irreversibility of each

device in the system. Furthermore, exergy analysis can also help to evaluate the improvement degree in the exergy efficiency in comparison with the conventional cycle.

For the exergy analysis, the procedure presented by Zhang et al [36] and Ma et al [14] was used. It is assumed that the chemical exergy and kinetic and potential exergies are ignored, and only the physical exergy is considered.

For the refrigerant flowing in a refrigerating system, the specific exergy at any state points is expressed as follows:

$$Ex = (h - h_0) - T_0(s - s_0) \quad (25)$$

For q at constant temperature T , the heat exergy rate Ex_q can also be calculated by:

$$Ex_q = \left(1 - \frac{T_0}{T}\right)q \quad (26)$$

The exergy destruction for the components: compressor, condenser, ejector, expansion valve and evaporator in EERC system is calculated from the following relationships:

In the compressor:

$$Ex_{comp} = T_0(s_2 - s_1) \quad (27)$$

In the condenser:

$$Ex_{cond} = h_2 - h_3 - T_0(s_2 - s_3) \quad (28)$$

In the ejector:

$$Ex_{ej} = T_0((1 + \mu)s_6 - s_3 - \mu s_9) \quad (29)$$

In the throttle valve:

$$Ex_{tv} = T_0(s_8 - s_7) \quad (30)$$

In the evaporator:

$$Ex_{evap} = T_0\mu[(s_9 - s_8) + (h_8 - h_9)/T_r] \quad (31)$$

Where $T_r = T_e + 5$ [14]

The total exergy destroyed of the EERC system is the sum of exergy destruction in each element of the cycle is by the following equation:

$$Ex_{Tot} = Ex_{comp} + Ex_{cond} + Ex_{ej} + Ex_{tv} + Ex_{evap} \quad (32)$$

The exergy efficiency of the EERC system is calculated by:

$$\eta_{ex} = 1 - \frac{Ex_{Tot}}{w_{comp}} \quad (33)$$

The decrease in Ex_{Tot} and improvement in exergy efficiency of the EERC system over the conventional mechanical cycle are [14, 36] :

$$Ex_{Tot,imp} = \frac{Ex_{Tot,EERC} - Ex_{Tot,BC}}{Ex_{Tot,BC}} \quad (34)$$

$$\eta_{ex,imp} = \frac{\eta_{ex,EERC} - \eta_{ex,BC}}{\eta_{ex,BC}} \quad (35)$$

Based on the mathematical model built above, a computer program was developed in MATLAB and the refrigerants thermodynamic properties were obtained using REFPROP Version 9.0 to investigate the performance potential of the EERC system in a wide range of working conditions using the working fluids R131I and R134a.

The detailed flowchart for the EERC system calculation procedure is presented in Figure 3.

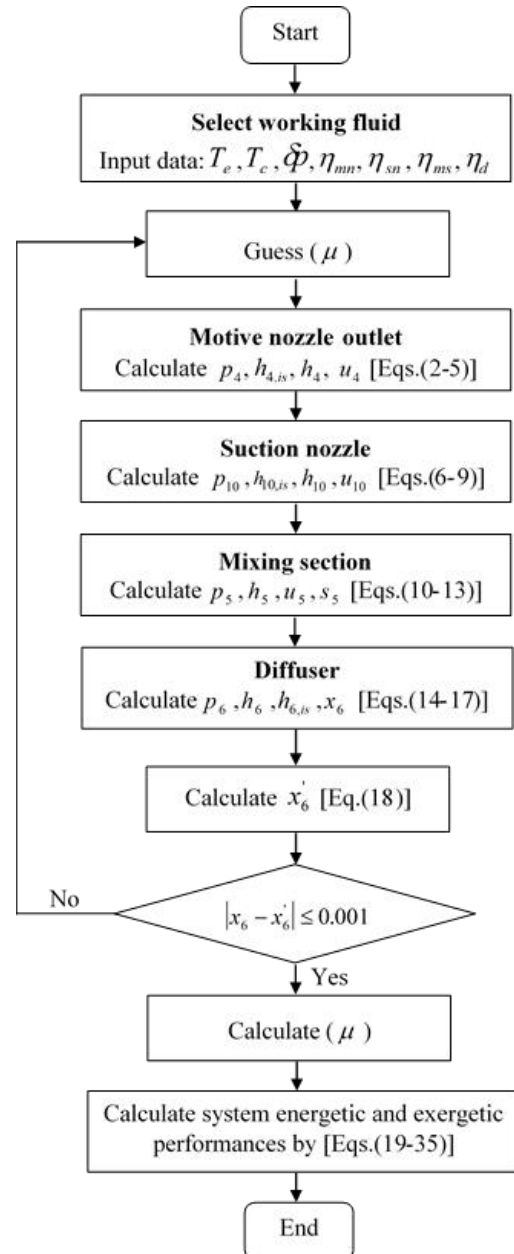

Figure 3. Flowchart for EERC cycle calculation procedure.

4. Results and Discussion

4.1 Validation With the Literature Data

Before using the developed program to evaluate the performance of the EERC system using eco-friendly R131I refrigerant, the program was validated by comparing the

values of the maximum COP reported by Li et al [30] and Sarkar [31] using the refrigerant R600a (Isobutane) as working fluid under the same operating conditions (condensation temperatures (T_c) vary from (35 to 55 °C) and the constant evaporation temperature (T_e) of 5°C).

The simulation results are illustrated in Figure 4 for different condenser temperatures.

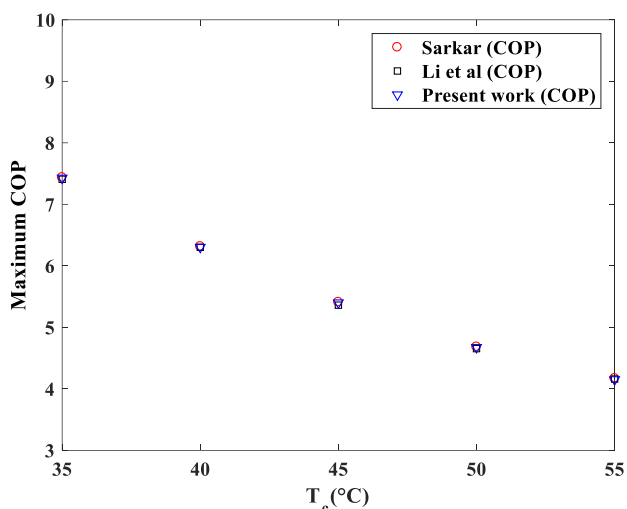

Figure 4. Validation of the present work results with those of [30, 31] results.

As can be seen, the values of the maximum COP of the refrigeration system (EERC) calculated using the developed program indicate a very good agreement with those of [29, 30], which confirms the validity of our simulation model.

4.2 Performance Characteristics of EERC

To explore the thermodynamic performances of the EERC system using eco-friendly R131I (Trifluoroiodomethane) refrigerant, the energetic and exergetic performances were made in the following working conditions: The condensing temperature is set at (40 °C) when T_e vary, and when T_c vary; the evaporating temperature is set at (5 °C). The ejector component efficiencies (motive nozzle (η_{mn}), suction nozzle (η_{sn}), mixing section (η_{ms}) and diffuser (η_d) are assumed to be constant at: ($\eta_{mn} = \eta_{sn} = \eta_d = 0.85$ and $\eta_{ms} = 0.95$) [34]. The reference environment temperature is set at 27 °C [36,37].

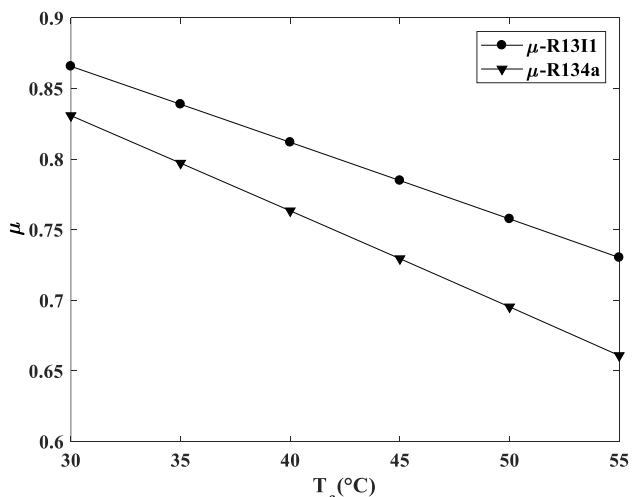

Figure 5. Influence of condensing temperature on μ .

Based on the model developed, the performances of EERC is investigated using R131I and compared with those of the traditional R134a refrigerant for various condensing temperature (30 to 55 °C) and evaporation temperature (-10 to 10 °C).

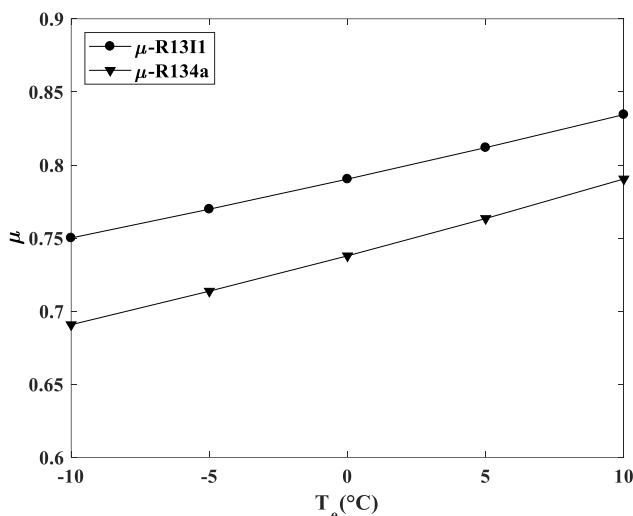

Figure 6. Influence of evaporating temperature on μ .

Figures 5 and 6 give the simulation results of the variation of the entrainment ratio (μ) values of the EERC system for both working fluids versus the condensing temperature (T_c) and the evaporating temperature (T_e), respectively.

It is noticed from the figures that the operating temperatures (T_c and T_e) has a great effect on the (μ). It could be observed that the (μ) of R131I and R134a increases with the evaporation temperatures which vary from -10 to 10 °C at a constant condensation temperature of 40 °C, and decreases with the condensation temperatures varying from 30 to 55 °C at a constant evaporation temperature of 5 °C. This is due to the fact that when the (T_e) rises from -10 to 10 °C, the primary mass flow rate (m_3), leaving from the condenser decreases, and the secondary mass flow rate (m_9), leaving from the evaporator increases, and hence the entrainment ratio (μ) increases.

The entrainment ratio (μ) is a function of the power consumption of the compressor and working fluids effect, so it directly affects the coefficient of performance of the EERC system.

On the other hand, when T_c raises from 30 to 55 °C, the primary mass flow rate (m_3), leaving from the condenser increases, and the secondary mass flow rate (m_9), leaving from the evaporator decreases, and hence the entrainment ratio (μ) decreases.

Compared with the traditional R134a refrigerant which has high GWP, the eco-friendly R131I refrigerant offers higher entrainment ratio (μ) than that of the R134a under the same operating temperatures (T_c and T_e).

The (μ) values calculated of the R131I and R134a decrease from (0.8657 to 0.7303) and from (0.8308 to 0.6609), respectively, as the (T_c) increases from (30 to 55 °C) as it can be observed from Figure 5. However, the (μ) values calculated of the R131I and R134a increase from (0.7501 to 0.8345) and from (0.6908 to 0.7905), respectively, as the (T_e) increases from (-10 to 10 °C) as it can be observed from Figure 6.

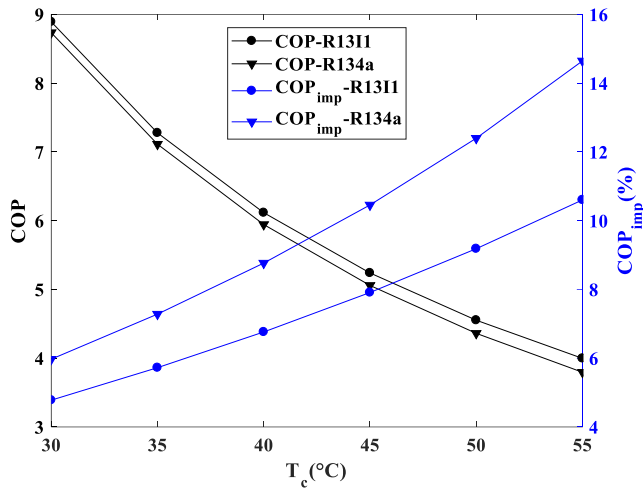

Figure 7. Influence of condensing temperature on COP and COP_{imp} .

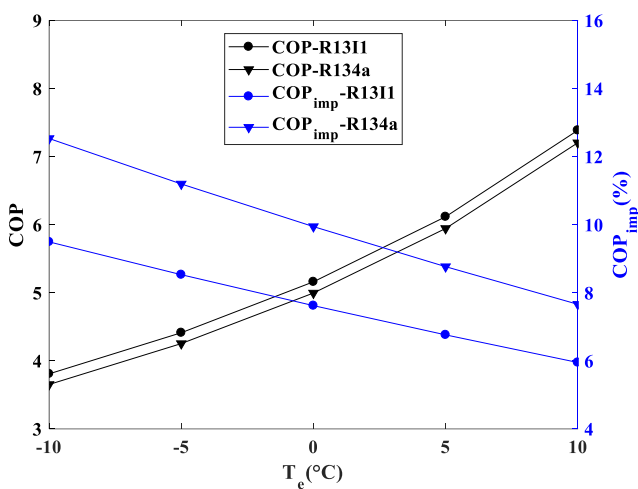

Figure 8. Influence of evaporating temperature on COP and COP_{imp} .

The simulation results of performance evolution of the EERC system, based on the maximum COP for both refrigerant R131I and R134a with the condensation temperatures (T_c) varying from 30 to 55 °C and with constant evaporation temperature of 5 °C and evaporation temperatures (T_e) varying from -10 to 10 °C with constant condensation temperature of 40 °C are shown in Figures 7 and 8, respectively.

The coefficient of performance can be defined as an energy efficiency index of the cooling equipment. It is clear that both curves of the coefficient of performance (COP) of the examined working fluids (R131I and R134a) decrease with the (T_c) and increase with the (T_e). This case can be interpreted by as the condenser exit temperature increases, the enthalpy of the working fluids (R131I and R134a) at the inlet to the evaporator increases. Meanwhile, the evaporator exit enthalpy remains constant and hence causing a low cooling effect and low coefficient of performance (COP). However, as the evaporator exit temperature increases, the pressure difference between the nozzle exit and the evaporator (p_9-p_4) increases. This has resulted in an increase in the secondary flow rate and hence, the COP and cooling capacity of the system have also increased. In addition, the reason for the COP increase or decrease is also due to that the COP is directly proportional to the ejector entrainment ratio.

On other hand, we can find that the benefit of the ejector is increased (higher COP_{imp}) at higher condensing temperatures (T_c) or lower evaporating temperatures (T_e) owing to the greater potential for expansion work recovery for the two fluids.

Compared with the traditional R134a refrigerant, this result reveals that the eco-friendly R131I refrigerant has a higher coefficient of performance which occurs due to its better thermodynamic properties and exhibited a lower coefficient of performance improvements (COP_{imp}) over the basic cycle for all studied temperatures T_c and T_e range.

The COP values calculated of the examined working fluids R131I and R134a decrease from 8.893 to 3.997 and from 8.735 to 3.795, respectively, as the (T_c) increases from 30 to 55 °C. However, they increase from 3.809 to 7.386 and from 3.652 to 7.203, respectively, as the (T_e) increases from -10 to 10 °C.

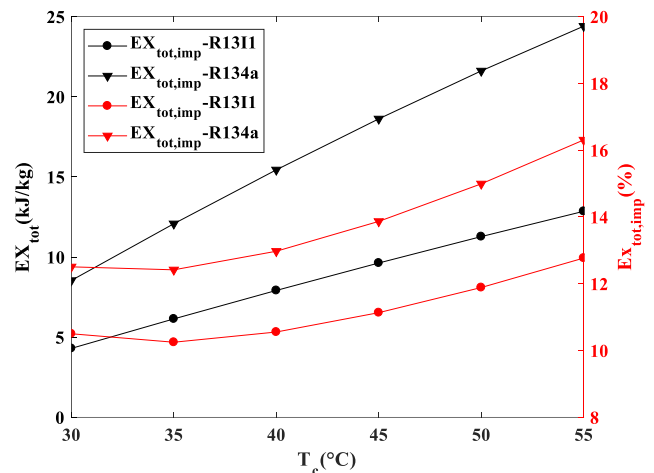

Figure 9. Influence of condensing temperature on Ex_{tot} and $Ex_{tot,imp}$.

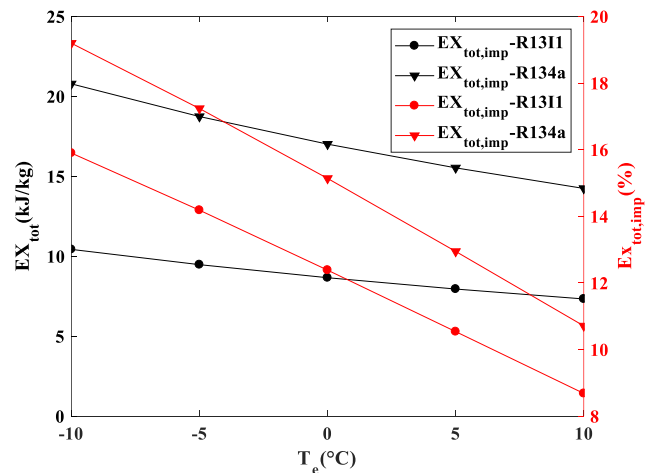

Figure 10. Influence of evaporating temperature on Ex_{tot} and $Ex_{tot,imp}$.

Figures 9 and 10 display the effect of the studied range of the condensing temperature ($T_c= 30$ to 55 °C with $T_e=5^\circ\text{C}$) and the evaporating temperature ($T_e= -10$ to 10 °C with $T_c=40^\circ\text{C}$) respectively, on the total exergy destruction of the investigated cycle using the examined refrigerants R131I and R134a as working fluids.

It can be seen from those results that as the (T_c) increases or the (T_e) decreases, the total exergy destruction of the investigated system increases. This can be interpreted by the fact that when the compressor pressure ratio becomes

superior, the compressor will need more input specific work (w_{comp}), and the heat rejection in the condenser will be higher for the same specific cooling (q_{evap}), resulting in superior exergy destruction for the refrigeration system.

Compared to the traditional R134a fluid, which has high GWP, the proposed candidate R131I has lesser total exergy destruction and offers lower exergy destruction decrement over corresponding basic cycle.

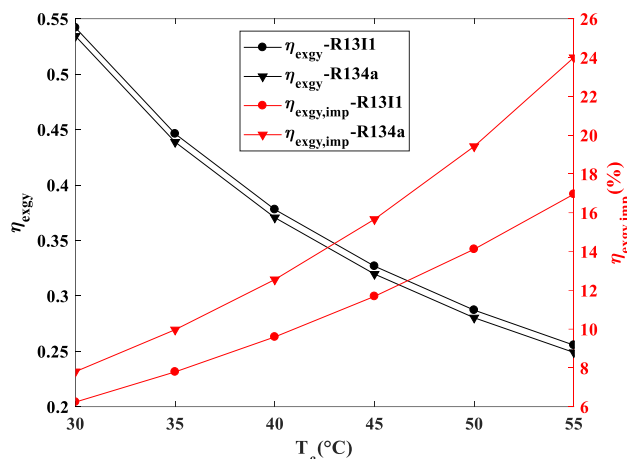

Figure 11. Influence of condensing temperature on η_{exgy} and $\eta_{exgy,imp}$.

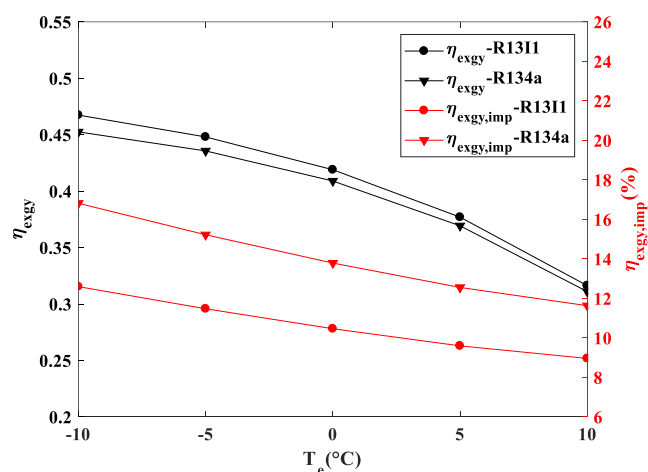

Figure 12. Influence of evaporating temperature on η_{exgy} and $\eta_{exgy,imp}$.

Using the investigated fluids R131I and R134a, the simulation results of the evolution of the exergy efficiency at $T_c=5^\circ\text{C}$ and for condensing temperatures ranging from (30 to 55°C), and at $T_c=40^\circ\text{C}$, and for the evaporating temperatures ranging from (-10 to 10°C) were presented respectively on Figures 11 and 12.

As shown in the figures, it is clear as the (T_c) or the (T_e) increases, the exergy efficiency of the studied cycle decreases. The exergy efficiency is based on the total exergy destruction and the input work of the compressor as mentioned in the equation (32), so when these two parameters increase with the increase of the condensing temperature (T_c), the total exergy destruction increases faster than that of the compressor work, which results in the decrease of exergy efficiency with the condensing temperature (T_c). On other hand, when the evaporator temperature (T_e) increases, the total exergy destruction, and the compressor work decrease and hence, the total exergy destruction decreases slower than that of the compressor

work, which results in the decrease of exergy efficiency with the evaporating temperature (T_e). It can also be seen that the eco-friendly R131I refrigerant has outperformed exergy efficiency compared with R134a refrigerant and exhibited lower exergy efficiency improvement over the corresponding conventional mechanical cycle.

The exergy efficiency of the studied refrigerants (R131I and R134a) varies from (0.2556 to 0.5419) and from (0.2490 to 0.5343), respectively, as the (T_c) increases from (30 to 55°C) as it can be observed from Figure 11, and from Figure 12 it can be seen that the exergy efficiency of the R131I and R134a varies from (0.3163 to 0.4674) and from (0.3110 to 0.4525), respectively, as the (T_e) increases from (-10 to 10°C).

On other hand, we can find that the exergy efficiency improvement is increased (higher $\eta_{ex,imp}$) at higher condensing temperatures or lower evaporating temperatures owing to the greater potential for expansion work recovery for both working fluids.

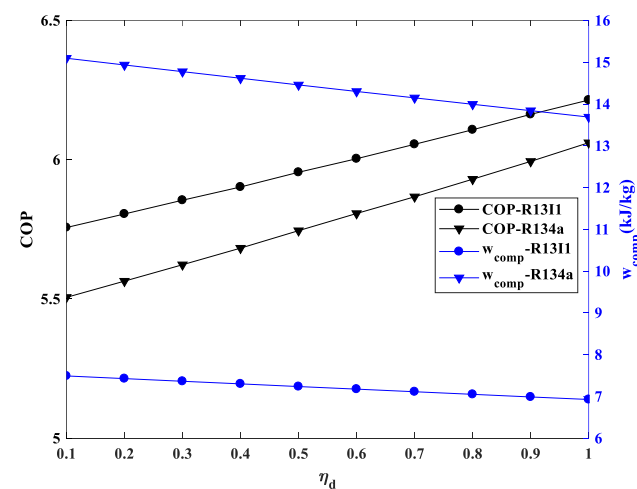

Figure 13. Variation of COP and compressor work with respect to diffuser efficiency of the ejector expansion device.

Figure 13 has been plotted to show the effect of diffuser efficiency of the ejector expansion device on the COP of the system and the specific work (w_{comp}) of the compressor working with the investigated refrigerants (R131I and R134a) with the same condensing temperature $T_c=40^\circ\text{C}$ and the evaporating temperature $T_e=5^\circ\text{C}$.

As shown in this figure, the result indicates that when the diffuser efficiency (η_d) of the ejector expansion device increase, the specific work of compression is lower. Since better efficiency has boosted the compressor inlet pressure, less compression work is needed by the compressor for a given compression ratio (π). As a result, the coefficient of performance (COP) increases as the diffuser efficiency (η_d) of the ejector expansion device increases as exposed in Figure 13.

Compared with the traditional R134a refrigerant, the eco-friendly R131I offers a lower specific work under the same operating temperatures ($T_c=40^\circ\text{C}$ and $T_e=-5^\circ\text{C}$), which confirms that it could be a good suitable substitute for the conventional working fluid R134a.

5. Conclusion

In this paper, a numerical model based on the energetic and exergetic methods of the EERC system is developed and validated to compare the performances of the eco-friendly

refrigerant R131I with the usually used fluid R134a in the EERC system under the same operating parameters.

The thermodynamic performances studied include the coefficient of performance (COP), the entrainment ratio (μ), the exergy destruction, and the exergy efficiency. Furthermore, the influences of evaporator and condenser temperatures on the EERC system performances and the influence of the isentropic efficiency of the diffuser section on the COP and on the compressor work are also examined and discussed.

The numerical results indicate that the R131I has a better performance, as well as lower exergy destruction compared to R134a.

Based on the results obtained from the present study, the main conclusions are listed as follows:

- The COP and μ for both working fluids R131I and R134a decrease with increasing the condenser temperature (T_c) and increase with the increasing evaporation temperature (T_e);
- The refrigerant R131I offers high better performances than R134a in terms of the entrainment ratio and the coefficient of performance under the same operating conditions;
- R131I refrigerant offers a lower exergy destruction compared to R134a for the same ranges of (T_c) and (T_e);
- The COP and the specific work are influenced by the diffuser efficiency (η_d) of the ejector expansion device;
- The COP increases and the compressor work decreases with the increase of the (η_d).

By analyzing the energetic performance of both studied working fluids, the investigated refrigerant R131I yields better performances in most of the cases, furthermore has excellent environmental properties, which confirms that it could be a suitable substitute for conventional working fluid R134a in the studied refrigeration system. From the results obtained, it would be very interesting to make a thermo-economic analysis in future works as well as research for new alternative azeotropic refrigerant blends.

Nomenclature

Symbols

| | |
|------------|--|
| COP | Coefficient of performance |
| h | Specific enthalpy [kJ kg^{-1}] |
| m | Mass flow rate [kg s^{-1}] |
| s | Specific entropy [$\text{kJ kg}^{-1} \text{K}^{-1}$] |
| u | Velocity [m s^{-1}] |
| q | Specific cooling [kJ kg^{-1}] |
| w | Specific work [kJ kg^{-1}] |
| p | Pressure [kPa] |
| T | Temperature [$^{\circ}\text{C}$ or K] |
| x | Vaporquality |
| δp | Pressure drop [kPa] |
| Ex | Exergy [kJ kg^{-1}] |

Greek letters

| | |
|--------|---------------------------------|
| μ | Entrainment ratio of ejector |
| η | Efficiency |
| ρ | Density [kg m^{-3}] |
| π | Compression ratio (P_2/P_1) |

Subscripts

| | |
|------|---------------------------|
| 0 | Reference environment |
| BC | Basic refrigeration cycle |

| | |
|--------------------------|---------------------------|
| c | Condensing process |
| $comp$ | Compressor |
| $cond$ | Condenser |
| d | Diffuser |
| e | Evaporation process |
| $evap$ | Evaporator |
| ej | Ejector |
| tv | Throttle valve |
| is | Isentropic process |
| imp | Improvement |
| ms | Mixing chamber |
| mn | Motive nozzle |
| sn | Suction nozzle |
| Tot | Total |
| r | Refrigerated object |
| 1-10 | State point |
| Refrigerants name | |
| R134a | 1,1,1,2-Tetrafluoroethane |
| R131I | Trifluoriodomethane |

References:

- [1] W.T.Tsai, "Environmental risks of new-generation fluorocarbons in replacement of potent greenhouse gases," *Int. J. Glob. Warm.*, 5,84–95, 2013, doi:10.1504/IJGW.2013.051484.
- [2] A. Mota-Babiloni, J. Navarro-Esbrí, Á. Barragán-Cervera, F. Molés, and B. Peris, "Analysis based on EU Regulation No 517/2014 of new HFC/HFO mixtures as alternatives of high GWP refrigerants in refrigeration and HVAC systems," *Int. J. Refrig.*, 52,21–31, 2015, doi:10.1016/j.ijrefrig.2014.12.021.
- [3] J. Zhang, B. Elmegaard, and F. Haglind, "Condensation heat transfer and pressure drop characteristics of zeotropic mixtures of R134a/R245fa in plate heat exchangers," *Int. J. Heat. Mass. Transf.*, 164,120577, 2021, doi:10.1016/j.ijheatmasstransfer.2020.120577.
- [4] AA. Kornhauser, "The Use Of An Ejector as Refrigerant Expander," *Int. J. Refrig. Air. Cond.*, 1990, doi:10.1109/IECEC.1990.747930.
- [5] J. Sarkar, "Ejector enhanced vapor compression refrigeration and heat pump systems - A review," *Renew Sustain Energy Rev.*, 16, 6647–6659 2012, doi:10.1016/j.rser.2012.08.007.
- [6] M. Yari, "Exergetic analysis of the vapour compression refrigeration cycle using ejector as an expander," *Int. J. Exergy*, 5,326–340, 2008, doi:10.1504/IJEX.2008.018114.
- [7] E. Nehdi, L. Kairouani, and M. Bouzaina, "Performance analysis of the vapour compression cycle using ejector as an expander," *Int. J. Energy. Res.*, 31,364–375, 2007, doi:10.1002/er.1260.
- [8] Bilir HKE. Nagihan, "Performance improvement of the vapour compression refrigeration cycle by a two-phase constant area ejector," , 33,23–40, 2012, doi:10.1002/er.
- [9] P. Chaiwongsa, and S. Wongwiset, "Experimental study on R-134a refrigeration system using a two-phase ejector as an expansion device," *Appl Therm Eng.*, 28,467–477, 2008, doi:10.1016/j.applthermaleng.2007.05.005.

- [10] J. Sarkar, "Optimization of ejector-expansion transcritical CO₂ heat pump cycle," *Energy*, 33,1399–1406, 2008, doi:10.1016/j.energy.2008.04.007.
- [11] S. Elbel, and P. Hrnjak, "Experimental validation of a prototype ejector designed to reduce throttling losses encountered in transcritical R744 system operation," *Int. J. Refrig.*, 31, 411–422,2008, doi:10.1016/j.ijrefrig.2007.07.013.
- [12] HK. Ersoy, and N. Bilir, "Performance characteristics of ejector expander transcritical CO₂ refrigeration cycle," *Proc Inst Mech Eng Part A J Power Energy*, 226,623–635, 2012, doi:10.1177/0957650912446547.
- [13] Y. Gao, G. He, D. Cai, and M. Fan, "Performance evaluation of a modified R290 dual-evaporator refrigeration cycle using two-phase ejector as expansion device," *Energy*, 212,118614, 2020, doi:10.1016/j.energy.2020.118614.
- [14] Z. Ma, X. Liu, H. Wang, H. Li, and X. Wang, "Off-Design Analysis of Hydrocarbon-based Ejector-Expansion Refrigeration Cycle," *Energy Procedia*, 105, 4685–4690, 2017, doi:10.1016/j.egypro.2017.03.1015.
- [15] A. Shen, K. Guan, X. Yang, S. Jin, and L. Yang, "Theoretical analysis of a novel liquid-vapor separation condensation ejector refrigeration cycle with zeotropic mixtures," *Energy Convers Manag.*, 223,113322, 2020, doi:10.1016/j.enconman.2020.113322.
- [16] Y. Liu, and J. Yu, "Performance evaluation of an ejector subcooling refrigeration cycle with zeotropic mixture R290/R170 for low-temperature freezer applications," *Appl Therm Eng.*, 161, 114128, 2019, doi:10.1016/j.applthermaleng.2019.114128.
- [17] KKI. Al-Chlaihawi, and K. Al-Farhany, "A Comprehensive Energetic and Exergetic Analysis of an Ejector Expansion Refrigeration Cycle Using R22 and R410A," *Int J Air-Conditioning Refrig.*, 29, 2150013, 2021, doi:10.1142/S2010132521500139.
- [18] L. Zhao, X. Yang, S. Deng, H. Li, and Z. Yu, "Performance analysis of the ejector-expansion refrigeration cycle using zeotropic mixtures," *Int. J. Refrig.*, 57, 197-207, 2015, doi:10.1016/j.ijrefrig.2015.05.006.
- [19] G. Yan, T. Bai, and J. Yu, "Thermodynamic analysis on a modified ejector expansion refrigeration cycle with zeotropic mixture (R290/R600a) for freezers," *Energy*, 95, 144-154, 2016, doi:10.1016/j.energy.2015.11.067.
- [20] P. Jakończuk, K. Śmierciew, H. Zou, D. Butrymowicz, and A. Dudar, "Temperature drop of heating fluid as a primary condition for effective utilization of low-grade heat using flash cycles and zeotropic mixtures in refrigeration ejector systems," *Energy Sources, Part A Recover Util Environ Eff*, 1–19, 2021, doi:10.1080/15567036.2021.1876185.
- [21] TA. Jacob, and BM. Fronk, "In-Tube condensation of zeotropic refrigerant R454C from superheated vapor to subcooled liquid," *Sci Technol Built Environ.*, 26,1177–1190, 2020, doi:10.1080/23744731.2020.1804281.
- [22] SC. Yelishala, K. Kannaiyan, Z. Wang, H. Metghalchi, YA. Levendis, and R. Sadr, "Thermodynamic Study on Blends of Hydrocarbons and Carbon Dioxide as Zeotropic Refrigerants," *J Energy Resour Technol.*, 142,19-1855, 2020, doi:10.1115/1.4045930.
- [23] JM. Calm, "The next generation of refrigerants – Historical review, considerations, and outlook," *Int. J. Refrig.*, 31,1123–1133, 2008, doi:10.1016/J.IJREFRIG.2008.01.013.
- [24] H. Chen, DY. Goswami, and EK. Stefanakos, "A review of thermodynamic cycles and working fluids for the conversion of low-grade heat," *Renew Sustain Energy Rev.*, 4,3059–3067, 2010, doi:10.1016/j.rser.2010.07.006.
- [25] YY. Duan, L. Shi, LQ. Sun, MS. Zhu, and LZ. Han, "Thermodynamic Properties of Trifluoroiodomethane (CF₃I)," *Int. J. Thermophys.*, 21,393–404, 2000, doi:10.1023/A:1006683529436.
- [26] L. Benussi, S. Bianco, D. Piccolo, S. Colafranceschi, J. Kjølbro, A. Sharma, D. Yang, G. Chen, Y. Ban, and Q. Li "Properties of potential eco-friendly gas replacements for particle detectors in high-energy physics," *J. Instrum.*, 13, P03012–P03012, 2018, doi:10.1088/1748-0221/13/03/P03012.
- [27] H. Guo, M. Gong, X. Dong, and J. Wu, "Measurements of (vapour+liquid) equilibrium data for {trifluoroiodomethane (R131I) + isobutane (R600a)} at temperatures between (263.150 and 293.150) K," *J. Chem. Thermodyn.*, 58,428–431, 2013, doi:10.1016/j.jct.2012.10.003.
- [28] X. Dong, M. Gong, J. Liu, and J. Wu, "Experimental measurement of vapor pressures and (vapor + liquid) equilibrium for {1,1,1,2-tetrafluoroethane (R134a) + propane (R290)} by a recirculation apparatus with view windows," *J. Chem. Thermodyn.*, 43,505–510, 2011, doi:10.1016/J.JCT.2010.11.001.
- [29] Y. Maalem, S. Fedali, H. Madani, and Y. Tamene, "Performance analysis of ternary azeotropic mixtures in different vapor compression refrigeration cycles," *Int. J. Refrig.*, 119,139–151, 2020, doi:10.1016/j.ijrefrig.2020.07.021.
- [30] H. Li, F. Cao, X. Bu, L. Wang, and X. Wang, "Performance characteristics of R1234yf ejector-expansion refrigeration cycle," *Appl Energy*, 121, 96-103,2014, doi:10.1016/j.apenergy.2014.01.079.
- [31] J. Sarkar, "Performance characteristics of natural-refrigerants- based ejector expansion refrigeration cycles," *Proc Inst Mech Eng Part A J Power Energy*, 223, 543-550, 2009, doi.org/10.1243/09576509JPE753.
- [32] K. Sumeru, H. Nasution, and FN. Ani, "A review on two-phase ejector as an expansion device in vapor compression refrigeration cycle," *Renew Sustain Energy Rev.*, 16,4927–4937, 2012, doi:10.1016/j.rser.2012.04.058.
- [33] S. He, Y. Li, and RZ. Wang, "Progress of mathematical modeling on ejectors," *Renew Sustain Energy Rev.*, 13,1760–1780, 2009, doi:10.1016/j.rser.2008.09.032.
- [34] A. Khalil, M. Fatouh, and E. Elgendy, "Ejector design and theoretical study of R134a ejector refrigeration cycle," *Int. J. Refrig.*, 34,1684–1698, 2011, doi:10.1016/j.ijrefrig.2011.01.005.

- [35] O. Brunin, M. Feidt, and B. Hivet, "Comparison of the working domains of some compression heat pumps and a compression-absorption heat pump," *Int. J. Refrig.*, 20, 308-318, 1997, doi:10.1016/S0140-7007(97)00025-X.
- [36] Z. Zhang, L. Tong, L. Chang, Y. Chen, and X. Wang, "Energetic and Exergetic Analysis of an Ejector-Expansion Refrigeration Cycle Using the Working Fluid R32," *Entropy.*, 17, 4744-4761, 2015, doi:10.3390/e17074744.
- [37] J. Yu, H. Chen, Y. Ren, and Y. Li, "A new ejector refrigeration system with an additional jet pump," *Appl Therm Eng.*, 26, 312-9, 2006, doi:10.1016/j.applthermaleng.2005.04.018.