



Effects of using UHSS material for weight reduction of Cukurova 885 model backhoe loader boom element

Zelal Gurbet¹ , Ümit Karahan^{1*}  and Mustafa Özcanlı² 

¹ Cukurova Machinery Manufacturing and Trade Joint Stock Company, Mersin, 33470, Turkey

² Automotive Engineering Department, Faculty of Engineering, Cukurova University, Adana, 01330, Turkey

Abstract

Construction machines have played an important role in building and sustaining civilizations in all walks of human life by making human life easier for centuries. These heavy machines consume a lot of fuel due to their high energy consumption and cause severe damage to the environment. Studies are being conducted to avoid harmful gas emissions due to fuel consumption of vehicles. One of the methods used in these studies is weight reduction. In this study, the fuel saving achieved by weight reduction with the material change in the boom element of a backhoe loader was investigated. The 3D model of the boom element of the backhoe loader model Cukurova885 was used for the study. The Ansys Workbench Software was used for the study. The weight of the reference model was reduced by reducing the dimensions of the reference model by using Ansys Spaceclaim in the software. Ultra-High Strength Steel with the same density but higher strength was used instead of the ST52 material currently used. The structural analyzes were carried out using the finite element method by applying exactly the same loads to the ST52 reference model and the weight-reduced UHSS model. In the study, thickness reductions on the model were made in Ansys Space Claim, a component of Ansys Workbench Software. In the Space Claim component, changes can be made to the geometry of a model imported into Ansys. For static structural analysis, Ansys Mechanical, a component of Ansys Software, was used. The model, whose thickness and therefore its weight is reduced in Space Claim, is opened in Mechanical, the necessary parameters are entered and it is prepared for analysis. Afterwards, analysis is performed via Ansys Mechanical. Comparing the results obtained, it was found that the weight of the model decreased by 23.16% and a fuel saving of 16.49% was achieved by using UHSS. Higher deformation and stress values were obtained for the model with UHSS. The safety factor was found to be 1.22 for the ST52 model and 2.14 for the UHSS model.

Keywords: Ansys; Backhoe loader; Boom; Finite element method; UHSS.

Research Article

History

Received 14.06.2023
Revised 20.09.2023
Accepted 06.10.2024

Contact

* Corresponding author
Zelal Gurbet
zelalgurbet@cumitas.com
Address: Cukurova Machinery Manufacturing and Trade Joint Stock Company, Mersin, Turkey
Tel:+905449099467

To cite this paper: Gurbet, Z., Karahan, Ü., Özcanlı, M. Effects of using UHSS material for weight reduction of Cukurova 885 model backhoe loader boom element. International Journal of Automotive Science and Technology. 2024; 8 (1): 78-86. <http://dx.doi.org/10.29228/ijastech.1314231>

1. Introduction

Machines are structures that generate, convert or transmit energy, and in general terms they are divided into engines and working machines. Engines convert energies such as heat, hydraulics, electricity into mechanical energy; whereas construction machines convert mechanical energy into mechanical work. While engines are named after the energy converted, construction machinery is again divided into different groups such as machine tools, textile machinery, road machinery and construction machinery [1].

Backhoe loaders are one of the most commonly used construction machines. Backhoe loaders, which consist of a loading bucket at the front and an excavator section, are commonly used in sectors such as construction, agriculture and mining. They are

also commonly used on the construction sites of various structures, especially for excavation and backfill work. Foundation excavation on construction sites, canal construction, etc. This is the part of the excavator that is used in excavation work. The part used to transport the material loaded on the machine from one place to another is the loader part. These heavy machines are subjected to a lot of force.

The loader part of a backhoe loader consists of the boom, stick, bucket and hydraulic cylinders. The boom is the largest part of the excavator section. It is connected to the upper carriage of the backhoe loader via the boom cylinder and to the arm section via the arm cylinder. The boom is moved by a cylinder mounted on the boom. It is connected to the boom through the stick cylinder and to the bucket through the bucket cylinder. The bucket is the

part of the excavator that comes into contact with the workpiece. Since it comes into contact with abrasive materials such as earth, sand, gravel and stone, the choice of material is very important when manufacturing the bucket. The selected material is subjected to surface hardening against wear and covered with wear plates. The hydraulic cylinder, cylinder base and piston rod head are manufactured with an articulated joint [1].

These machines, which are subjected to great force and are used for great work, are made up of many parts and each part has a different meaning. However, the boom and the pole are the largest of these parts and both are indispensable. These two parts are the heaviest and most critical parts of backhoe loaders. They are more difficult to replace than other parts. When moving the machine, most of the force is absorbed by these parts. Accordingly, boom and stick parts are very important for the operation and function of the backhoe loader.

Since construction machines are used in heavy work and transmit large forces, it is necessary to work on the development of these machines. However, as these machines are made of very large and heavy materials, it is not always possible to conduct experimental studies on them. Thank you to developing technology and computer software, this problem has been partially solved. There are studies being conducted for these machines in the computer environment [2-5; 12].

The same is true for booms and stick elements, which are important parts of backhoe loaders. Since these are important parts, they need to be developed and researched. Experimental research on these parts is not always possible. However, in the computer environment, there are studies on these parts in analysis programmes that use the finite element method.

For example, there is a study in which different dredger arm designs were investigated using Ansys software and the finite element method [6]. In this study, the effect of material changes and design improvements on the weight of the arm of an excavator model was investigated. The stresses of the different arm designs were investigated using Ansys Workbench Software. As a result of this study, it was found that the weight of the excavator arm can be significantly reduced by design and material changes if it is ensured that the design remains within safe limits.

In another study, dredger arms were analyzed with the finite element method using Catia, Hypermesh and Radioss Linear [7]. The FEA results obtained were compared with similar studies carried out with the CAD model using Abaqus. Examination of the analysis results obtained in this study leads to the conclusion that the analyzes can be used to control the strength of dredging elements.

In another study, the design and optimization of the outrigger element is presented [8]. CATIA was used for 3D model drawing, Hyper mesh for meshing and Ansys for solutions. The optimization was done with Opti struct.

In another study where analysis was made using Ansys Workbench software, vibration analysis of a tractor cabin was carried out computer-aided. After the vehicle cabin was modeled in the

specified dimensions, modal analysis was performed and 12 natural frequencies were obtained for 3 separate cabin models designed. If the vibration drive frequencies caused by road roughness and other reasons are equal to or close to the natural frequencies of the vehicle cabin, vibrations in the cabin increase. For this reason, the natural frequencies of the designed cabin are aimed to be outside the frequency range of vibrations caused by external factors. During the solution phase, the analyzes and boundary conditions were determined and the modal analyzes of the modeled cabin were examined through "ANSYS Workbench Software" [17].

In another study on backhoe loaders, the structural optimization of the backhoe arm of the backhoe loader was studied. The aim of this study is to reduce the weight, fuel consumption and, accordingly, the cost of the machine, thus increasing the operating efficiency of the machine. During the analysis process applied to the current design, a new arm cylinder was designed as an alternative to the existing digger arm cylinder. While the new cylinder was designed to be lighter and move faster, care was taken not to change the connection points to adapt to the existing machine. Structural analyzes were carried out on the optimum structure obtained and it was examined whether the new model was suitable for working conditions in terms of strength. The existing design and the optimized design were compared in terms of strength and operating performance [18].

In another structural analysis study, the designs prepared using Creo Parametric were analyzed with the MSC Marc package program. In this study, a Z-Bar design was made in Creo for Hidromek wheel loader. It was analyzed using the finite element method at MSC Marc. Boundary conditions were defined at the forces where the Z-Bar part was stressed the most and the resulting reaction forces were applied to the part. Then, analysis solutions of alternative structures were evaluated and design improvements were made for the final product. As a result of the studies; The production of the Z-Bar part, which is one of the most critical parts for wheel loader machines, has been completed [19].

Another informative and helpful study regarding the modeling and FEA optimization studies currently carried out on construction machines can be presented as an example. This study is also a study that can contribute to the development of new excavator attachment designs. In the study, information was given about the software that can be used to perform modeling and finite element analysis of an excavator. PRO-ENGINEER, ADAMS, NASTRAN, CATIA, ANSYS, Hypermesh, Abaqus, I-deas, etc. were chosen according to the ease of use and accuracy of the results. software has been examined [20].

In their study, Bicer G. and Katmer M.C. studied a wheel loader and determined the boundary conditions to which the boom design of the machine is exposed and examined the strength performance of the design within the framework of these boundary conditions. The kinematically designed boom model was analyzed statically in the MSC Marc program. The

stress-time graph of the model was created from the data obtained and examined dynamically in terms of strength [21].

Kocakulak T. et al. In their study, they examined the performance values of an electric tractor model created in Matlab software. Considering the maximum speed of the electric tractor, energy consumption values for rotary harrow, atomizer and shredder tasks were examined. The model's reduction ratio was evaluated by determining the maximum speeds and the amount of energy consumed while performing different tasks when the reduction ratio was 50, 60, 70, 80, 90, 100. 62.25 if the reduction ratio of the electric tractor model is 50, 60, 70, 80, 90 and 100; 51.91; 44.52; 38.97; It was concluded that it reached maximum speed values of 34.65 and 31.19 km/h [22].

In another tractor study, Livatyali H. and Yel A. studied the wet clutch machine element used in agricultural work machines. In their work, a mathematical model of the wet clutch and electro-hydraulic control system was created, various operating situations were simulated and the behavior of all circuit elements was examined. Values such as pressure, temperature and speed obtained from various experiments were compared [23].

Similar to this study, in another study conducted using High Strength Steel, the formability of advanced steel sheets frequently used in the automotive industry was investigated. Deep drawing experiments were carried out using molds at four different angles (these angles are 0°, 7.5°, 12.5° and 20°) for DP800 and MART1400 steels, respectively, and it was examined whether a higher deep drawing ratio (DDR) could be obtained with this method. FEA was used to determine the DDR for each steel in different variations. The deep drawing suitability of MART1400 steel did not improve in experiments; It was found that the DDR of DP800 increased by 2.46% in deep drawing application at an angle of 20° [24].



Fig. 1. Cukurova 885 model backhoe loader

The weight problem of these machines is an important issue to work on. Due to their areas of use, heavy construction machines consume much more energy than normal vehicles. Their components are exposed to wear and tear from asphalt, rocks and other abrasive materials. At the same time, all frame structures must be rigid and strong to withstand the unloading loads. As the need for strong physical strength is met by the use of high-strength materials, this leads to excessive weight of construction equipment. As the weight increases, so does the fuel consumption of the construction machinery. In addition to the

economic damage caused by excessive fuel consumption, the negative impact on the environment is also great. As the amount of fuel consumed increases, so does the emission of pollutants into the atmosphere. This emission is one of the biggest threats to life in nature [9]. Weight reduction is also an important requirement in the design of construction equipment to save fuel after meeting safety requirements. In a general calculation of fuel consumption by weight, a 10% reduction in vehicle weight is expected to reduce fuel consumption by 5-7% [10].

In this study, the weight reduction on the boom element of the backhoe loader model Cukurova 885 was investigated. The backhoe loader model Cukurova 885 is shown in Figure 1. The weight reduction of the boom element using high strength steel (UHSS) was carried out in a computer environment via ANSYS Space Claim, a component of the Ansys software. UHSS is a material with the same density value as mild steel but with higher strength. The ST52 steel material is used in the production of the backhoe loader of the Cukurova 885 model. The 3D solid model was obtained from Cukurova Machinery Manufacturing and Trade Joint Stock Company (CUMITAS). The dimensions of the model with UHSS were reduced in Ansys Space Claim, the weight was reduced and the analysis was done using finite element method in Ansys software. The analysis values of the model with ST52 and the analysis values of the model with UHSS were compared and the stress and deformation values were studied.

2. Material & Method Section

2.1. Material

The work is carried out in the computer environment in Ansys Workbench software. In this context, the solid model of the rear boom element of the backhoe loader model Cukurova 885 is used. Cukurova 885 is a model of backhoe loader that has been manufactured.

ST52 structural steel is used for the model. The solid model of the boom element was taken from the research and development department of Cukurova Machinery Manufacturing and Trade Joint Stock Company. The 3D solid model of the boom element of the Cukurova 885 model backhoe loader is shown in Figure 2.

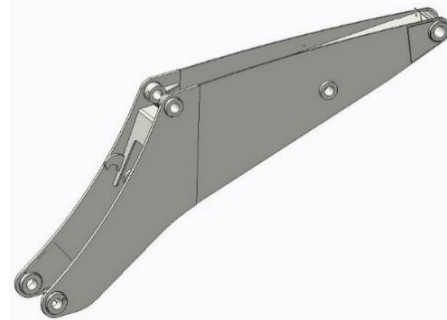

Fig. 2. Rear boom of Cukurova 885 model backhoe loader

ST 52 refers to steel material with a tensile strength of at least 52 kg/mm. This material is used in steel construction, shipbuilding, tanks, containers, etc. It is a durable material that can be used for fabrication [11]. ST52 steel is a low-alloy, high-strength structural steel that can be easily welded to other weldable steels. ST52 steel, generally used in the manufacture of products requiring high strength, has a low carbon equivalent and is cold formable. Bridge, building, factory, etc. in the construction industry; in the manufacture of machine parts; It is used in the manufacture of cranes, booms, chassis [9].

The model from the R&D department of Cukurova Machinery Manufacturing and Trade Joint Stock Company was arranged on Space Claim, which is included in the Ansys Workbench software, and its dimensions were reduced. Some of the parts with reduced thickness of the model are shown in Figure 3 to Figure 12.

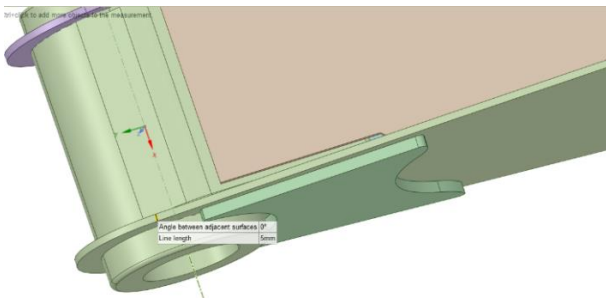

Fig. 3. 5 mm thick side plate



Fig. 4. Side plate thinned from 5 mm to 4 mm

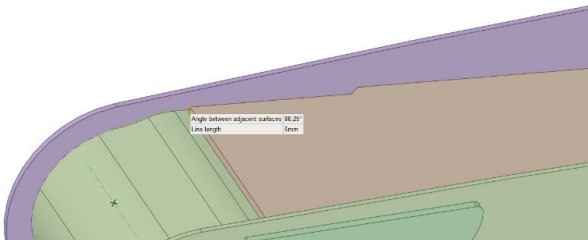

Fig. 5. 5 mm thick top plate

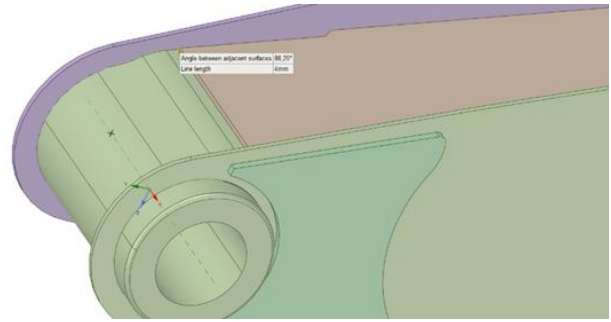

Fig. 6. Top plate thinned from 5 mm to 4 mm

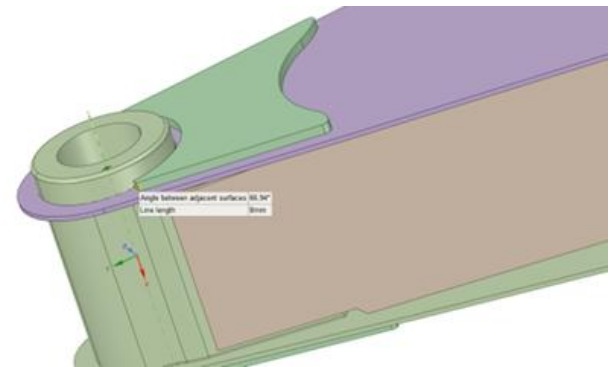

Fig. 7. 8 mm thick side plate

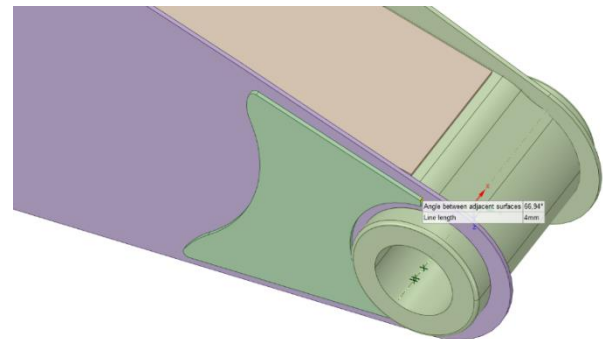

Fig. 8. Side plate thinned from 8 mm to 4 mm

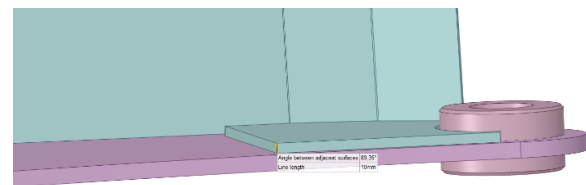

Fig. 9. 10 mm thick inner plate

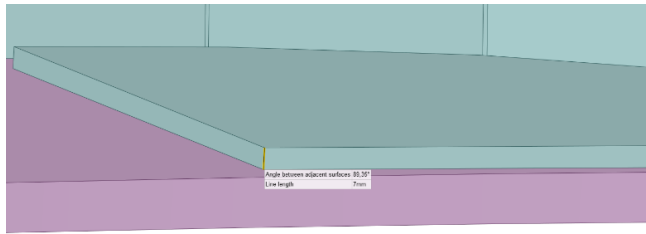

Fig. 10. Inner plate thinned from 10 mm to 7 mm

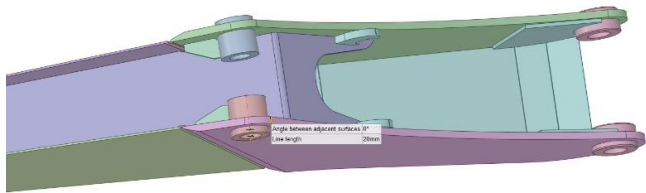

Fig. 11. 20 mm thick outer plate

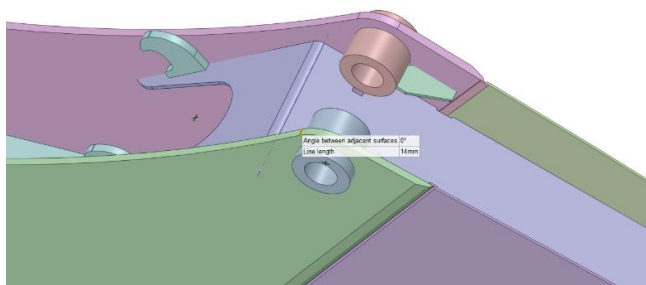

Fig. 12. Outer plate thinned from 20 mm to 14 mm

There are no special selection criteria for parts with reduced thickness in the model. In general, efforts have been made to reduce the thickness of all parts. But only at the connection points of the boom model with other parts, the thicknesses were not reduced in order to avoid dimensional incompatibilities with the connection materials. With the thickness reductions and subsequent thickness reductions shown in the figures, a lighter model was obtained. UHSS material is used for the reduced weight model. The mechanical properties of UHSS material and ST52 steel are given in Table 1.

Table 1. ST52 and UHSS properties

	Density (kg/m ³)	Young's Modulus (GPa)	Tensile Yield Strength (MPa)	Tensile Ul- timate Strength (MPa)	Poisson's Ratio
ST52	7850	210	355	530	0.3
UHSS	7850	200	1100	1500	0.3

There is no specific tensile strength for UHSS. Steel producers accept different values such as 780 MPa, 980 MPa as tensile strength of UHSS within their own structure. The steel manufacturers' association WorldAutoSteel has classified steels according

to their minimum tensile strength [9]. High strength steels (AHSS) ≥ 550 MPa TS; ultra high strength steels (UHSS) ≥ 780 MPa TS; GigaPascal steels are classified as ≥ 1000 MPa or 1 GPa TS. However, WorldAutoSteel acknowledges that there is no common tensile strength value for UHSS in the AHSS Application Guidelines 2021.

UHSS steels can include the following steels as material: Martensitic (M), Press Hardened Steel (PHS; hardenable boron steel; "hot formed" steels), Complex Phase (CP), High Edge Toughness (HE), Dual Phase (DP), High Ductility Dual Phase (DH), Ferritic Bainitic (FB).

The term "UHSS" refers to steel grades that have higher strength than "AHSS" in areas where steel materials are used. UHSS steels offer higher safety conditions. As its density is the same as mild steel, the required strength can be achieved with less material. This means lighter material [9].

2.2. Method

2.2.1 Finite Element Method

In the study, thickness reductions on the model were made in Ansys Space Claim, a component of Ansys Workbench Software. In the Space Claim component, changes can be made to the geometry of a model imported into Ansys. For static structural analysis, Ansys Mechanical, a component of Ansys Software, was used. The model, whose thickness and therefore its weight is reduced in Space Claim, is opened in Mechanical. Here, the materials previously defined in Ansys Software are assigned to the parts of the model. Mesh settings and connection checks are made. Fixed supports and the forces to be applied are determined and detailed. Afterwards, the parameters desired to be obtained as a result of the analysis are selected. In this study, Total deformation, Equivalent stress, Safety factor parameters were selected. Finally, the model is analyzed and values are obtained.

Ansys is a software that performs analyzes using the finite element method. This method is a method that works on the principle of going from the part to the whole, dividing the problem into equal parts and using approximate results to solve the main problem. With this method, problems that take a long time to solve can be solved in a shorter way. It is mainly used in stress analysis. This method is also used in other types of analysis. When studied as a sector, it is also used in various fields of engineering, medicine, orthopaedics and surgery [13].

In the stress analyzes performed in Ansys software, the stresses, the locations of the stresses and the deformations of the model whose analysis is completed can be seen.

When performing stress analysis in computer software, the analysis of shapes and forms of models is quite complex. When analysing with the finite element method, the model is divided into small parts with a mesh structure that is easier to solve. Each of these parts is called a 'finite element'. The division of the geometric model into elements that can be analyzed in this way is called a 'numerical model'. The points at which the finite elements come into contact with each other are the nodes. The higher the number

of finite elements, the more sensitive the stress distributions and the closer the solution is to reality [13].

In this study, static structural analysis was applied to the element of the rear boom of the backhoe loader model Cukurova 885 in the ANSYS Workbench software. The boom, which is currently made of ST52 material, was transformed into a thinner structure by using UHSS properties. The analyzes were carried out on two different models, namely the original version of the 3D model of the Cukurova 885 backhoe loader and the new model with reduced weight. Using the ST52 material for the original model and the UHSS material for the new reduced weight model, exactly the same forces were applied to the two models from the same areas in the same directions. The applied forces were approximated using information from the studies [2, 7, 8] examined during the literature review. The force values and fixed supports that acted on both models are shown in Figure 13 to Figure 15 and Table 2.

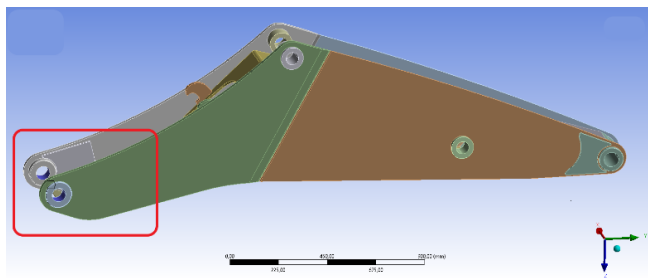

Fig. 13. Fixed support regions-1

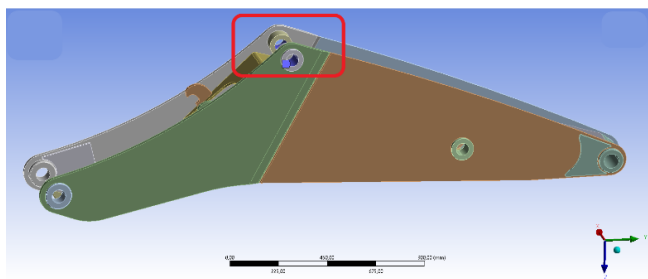

Fig. 14. Fixed support regions-2

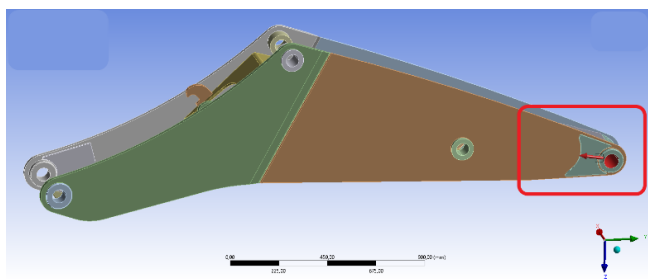

Fig. 15. Force regions

Table 2. Details of force

Component	Force (N)
X	0
Y	-170000
Z	-30000

3. Result and Discussions

By applying thickness reductions, a lighter model was obtained for use with UHSS. The mass and volume values of the original model and the model with reduced plate thickness are given in Table 3.

Table 3. Mass and volume values of the models

	Volume (cm ³)	Mass (kg)
Original model	38483	302.09
Model with reduced plate thicknesses	29572	232.14

If we compare the models of the boom, which are made of two different materials, we will see that the UHSS model is lighter. With the use of UHSS material, a reduction of 23.16% was achieved. The results of the analysis show that the safety factor is greater for the boom model whose dimensions have been reduced and whose weight has been reduced by using UHSS than for the ST52 boom model. 75. An increase of 41% in the safety factor was observed. The tension value of the UHSS boom model was also 76.81% higher than the tension value of the ST52 boom model. It was observed that the boom model with UHSS had 42.5% more deformation than the model with ST52. The analysis results are shown in Table 4 and Figure 16 to Figure 21.

Table 4. Analysis results

	ST52	UHSS
Weight(kg)	302.09	232.14
Total deformation(mm)	0.40	0.57
Equivalent (von-Mises) stress (MPa)	290.31	513.3
Safety factor	1.22	2.14

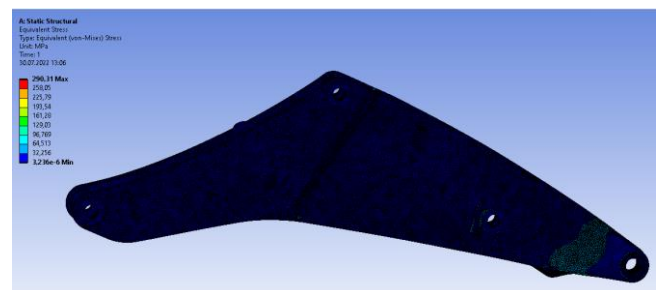

Fig. 16. Equivalent Stress analysis result of ST52 model

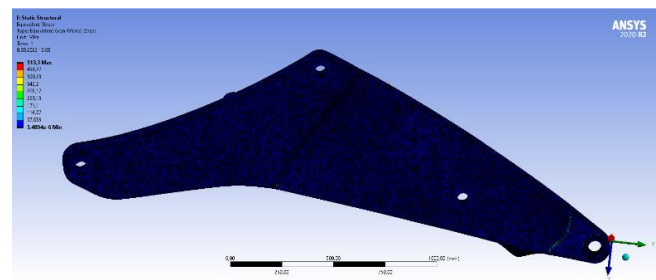

Fig. 17. Equivalent Stress analysis result of UHSS model

As can be seen in Figure 16 and Figure 17, the result of the analyzes carried out with equal forces under equal conditions is that the equivalent stress of the boom model with ST52 is 290.31 MPa and the equivalent stress of the boom model with UHSS is 513.3 MPa. The maximum equivalent stress of the UHSS model is higher than that of the ST52 model.

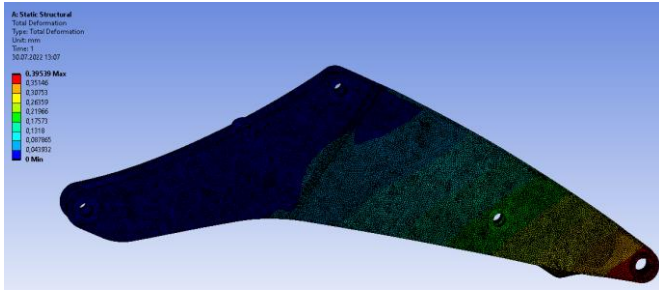

Fig. 18. Deformation analysis result of ST52 model

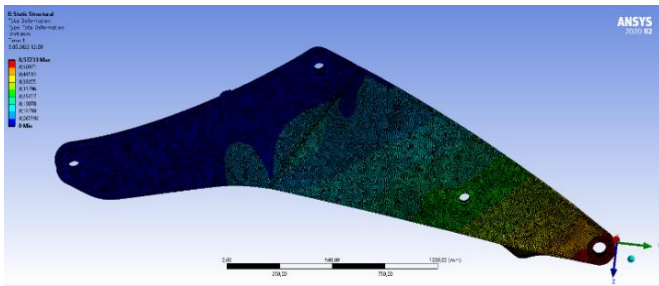

Fig. 19. Deformation analysis result of UHSS model

As can be seen in Figure 18 and Figure 19, the total deformation of the boom model with ST52 is 0.39539 mm and the total deformation of the boom model with UHSS is 0.57233 mm when equal forces are applied under equal conditions. The total deformation of the UHSS model is higher than that of the ST52 model. The deformation occurring when using UHSS material is higher than the deformation occurring when using ST52. However, when UHSS is used, the deformation value remains within safe limits.

As can be seen in Figure 20 and Figure 21, the result of the analyzes carried out with the same forces under the same conditions is that the safety factor of the cantilever model with ST52 is 1.2228 and the safety factor of the cantilever model with UHSS is 2.143. The safety factor of the UHSS model is higher than that of the ST52 model.

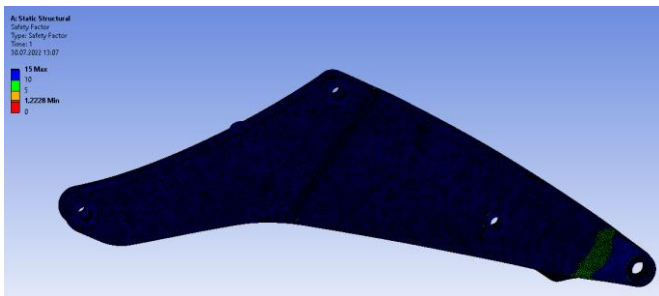

Fig. 20. Safety Factor analysis result of ST52 model

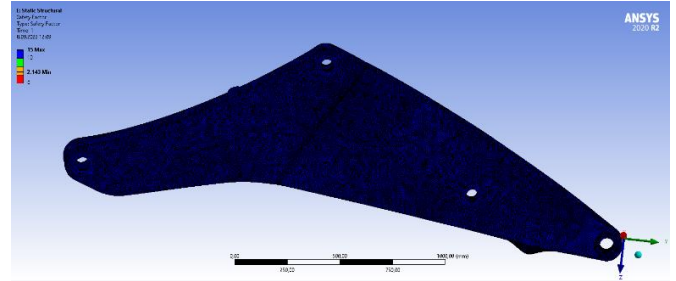

Fig. 21. Safety Factor analysis result of UHSS model

The analysis results show that weight reduction is possible if the stress values for the model used remain within safe limits. The weight of the boom model was reduced from 302.09 kg to 232.14 kg by using UHSS. The weight of the model was reduced by about 70.00 kg. In this study, a weight reduction of the model of 23.16% was achieved.

Considering the studies of Ghassemieh [14] and Karacor et al. [15], the savings that may occur in fuel consumption and the reduction that may occur in CO2 output have been determined approximately.

In their study, Karacor et al [15] analyzed the lorry chassis designed with mild steel (ST37) and UHSS material using Ansys Workbench software. In their study, the weight decreased from 1558.2 kg to 1335 kg when UHSS was used instead of ST37. It was observed that the deformation value decreased from 10,025 to 7,954, which is a weight reduction of 223 kg. With a weight reduction of 14.32%, the deformation decreased by 20.66%. In our study, the weight decreased from 302.09 kg to 232.14 kg and decreased by 69.95 kg. With a weight reduction of 23.16%, the deformation value increased from 0.40 to 0.57 and increased by 42.5%. Compared to Karacor's work, this is quite a high value. In his study, when the weight was reduced by 14.32%, the safety factor increased by 24.46%; the maximum stress value also increased by 84.85%. In our study, when the weight was reduced by 23.16%, the safety factor increased by 75.41%; the tension value increased by 76.81%. Compared to Karacor's study, the safety factor in our study increased more and tension increased less than in Karacor's study. Karacor et al. achieved a fuel saving of 10.02% with a weight reduction of 14.32%. If we make a calculation in our own study by taking this ratio as reference; Considering that the weight of the backhoe loader is approximately 8000 kg, the decrease of 69.95 kg in the boom model will correspond to a decrease of 0.87%. With a weight reduction of 0.87%, fuel savings of approximately 0.61% are expected.

Mahmud Khan F. et al [6] investigated the stresses of a dredger arm with different materials and different weight modifications. The results of Von Mises stresses and displacements were used for different materials to decide whether the designs were within safe limits. In this study, the finite element method was used for the calculations. The design was tested with 7 different materials and it was found that 4 of them were safe. When

alloy steel, 7050 t7651 aluminium alloy, ductile iron and titanium Ti8Mn (annealed) were used, the stresses studied were within safe limits. When Alloy Steel and 7050 t7651 Aluminium Alloy were used, the thicknesses in the model were first increased, then they were decreased twice and the weight reduction was investigated. When Alloy Steel was used, the weight decreased from 25.6 kg to 18 kg for an overall reduction of 7.6 kg. When using Aluminium Alloy 7050 t7651, the weight was reduced from 9.4 kg to 6.8 kg, a reduction of 2.6 kg. The stresses that occur with the weight reduction when using Alloy Steel are also investigated. The weight increased from an initial 25.6 kg to 29 kg when Alloy Steel was used; then it was reduced to 20.9 kg and finally to 18 kg. It can be seen that the weight reduction is 7.6 kg. In the reference study [16], the Von Mises stress, which was 229.39 MPa, decreased to 226.11 MPa when a weight reduction of 7.6 kg was achieved. While the displacement in the reference study [16] was 0.370 mm, it decreased to 0.218 mm when a weight reduction of 7.6 kg was achieved.

Choudhary A.K. et al [7] Finite element analysis of the dredge arm was carried out using CAE tools. CATIA software was used to create a three-dimensional (3-D) model of the working mechanism in the large arm of an excavator. After importing the file CAD into Hypermesh, geometry visualisation, geometry cleaning and symmetry checking were performed. The geometry was simplified and prepared for analysis, and meshing and quality control were completed. They used ANSYS finite element analysis (FEA) software to analysis the stiffness and strength of the dredge design. The FEA results obtained were compared with a similar study using ABAQUS on the CAD model. Separate comparisons were made for the excavation and pouring operations. For the excavation process, the obtained tensile value is 116.4 MPa, while the reference value obtained with Abaqus is less than 155.1 MPa. The resulting value for the displacement is 3.65 mm, which is significantly lower than the reference value of 6.9 mm. For the tilting process, the determined tensile value is 27.15 MPa, the reference value determined with Abaqus is below 64.8 MPa. The displacement value also determined is 0.8795 mm and the reference value remains below 1.2 mm. The analysis results show that the strength and stiffness of the arm are adequate and below the critical value.

Patill N. S. et al [9] studied the design and optimization of an excavator boom part. An FEA approach was used for the optimization. A 3D model of a boom was created in CATIA V5R19. The loads acting on the part were determined using various available sources, e.g. different reference documents, hand-made calculations and product catalogues. Meshing was done in Hyper mesh and Ansys was used for the solution. The deformations were studied and the maximum stress was checked. The resulting deformation is approximately 4.67 mm. The Von Mises stresses were found to be 248.47 MPa. Since the yield strength of the material is 1000 MPa, the stresses are within limits and hence the design is safe. Three different topology optimizations were performed using Opti struct. In the optimization results obtained, the stresses are below 1000 MPa, which is the

yield strength of the material. Therefore, the stresses are within the safe limit. After the optimization, a reduction of the total weight of about 120 kg was achieved, which reduces the performance of the boom and thus the costs.

4. Conclusions

In this study, the maximum stress, the distribution of total deformation and the factor of safety of the UHSS and ST52 boom models were investigated and a weight comparison of the booms was performed. As a result of the analysis, the following data was obtained:

- When UHSS material was used, a 69.95 kg lighter boom model was achieved.
- When UHSS is preferred, a significant weight reduction of 69.95 kg is achieved. This means a weight reduction of 23.16% compared to the ST52.
- When the calculation is made according to the reference studies, an estimated fuel saving of 0.61% is expected. This value is not an exact value, it is estimated as an approximation.
- With UHSS, the deformation value increased by 44.75% compared to ST52 steel.
- With UHSS, the equivalent stress value increases by 76.81% compared to ST52 steel.
- The safety factor of the boom model with ST52 is 1.2228. The safety factor of the model with UHSS is 2.143. With UHSS the value of the safety factor increases by 76.25% compared to ST52 steel.

Acknowledgment

This study was supported by the Cukurova University Scientific Research Projects Foundation with Project No: FYL-2022-14803. The 3D models used in the study were obtained from Cukurova Machinery Manufacturing and Trade Joint Stock Company. As researchers, we would like to thank Cukurova Machinery Manufacturing and Trade Joint Stock Company.

Nomenclature

<i>3D</i>	: 3 Dimension
<i>AHSS</i>	: Advanced High Strength Steel
<i>CAD</i>	: Computer Aided Design
<i>CAE</i>	: Computer Aided Engineering
<i>CM</i>	: Centimeter
<i>CO2</i>	: Carbon Dioxide
<i>CP</i>	: Complex Phase
<i>DP</i>	: Dual Phase
<i>DH</i>	: High Ductility Dual Phase
<i>FB</i>	: Ferritic Bainitic
<i>FEM</i>	: Finite Element Method
<i>FEA</i>	: Finite Element Analysis
<i>HE</i>	: High EdgeThouh
<i>M</i>	: Martensitic
<i>MM</i>	: Milimeter
<i>MPa</i>	: Mega Pascal

PHS : Press Hardened Steel
R&D : Research&Development
UHSS : Ultra High Strength Steel

Conflict of Interest Statement

The authors declare that there is no conflict of interest in the study.

CRedit Author Statement

Zelal Gurbet: Writing-original draft, Visualization

Ümit Karahan: Conceptualization, Validation,

Mustafa Özcanlı: Writing- review & editing, Supervision

References

- [1] Oyman OV. Ekskavator Kollarinin Tasarimi [thesis]. Yildiz Technical University; 2005.
- [2] Yu C, Bao Y, Li Q. Finite Element Analysis of Excavator Mechanical Behavior and Boom Structure Optimization. *Measurement*. 2021; 173: 108637. doi: 10.1016/j.measurement.2020.108637
- [3] Suryo SH, Bayuseno AP, Ramadhan JG. Simulation of Excavator Bucket Pressuring Through Finite Element Method. *Civil Engineering Journal*. 2018; 4(3): 478-487. doi: 10.28991/cej-0309107
- [4] Shaikh BP, Mulla AM. Analysis of Bucket Teeth of Backhoe Excavator Loader and its Weight Optimization. *International Journal of Engineering Research & Technology*. 2015; 4(05): 289-295. doi: 10.17577/ijertv4is050402
- [5] Suryo SH, Bayuseno AP, Jamari J, Wahyudi AI. Analysis of Rake Angle Effect to Stress Distribution on Excavator Bucket Teeth Using Finite Element Method. *Civil Engineering Journal*. 2017; 3(12): 1222-1234. doi: 10.28991/cej-030952
- [6] Khan FM, Islam MS, Hossain MZ. Design Aspects of an Excavator Arm. *International Review of Mechanical Engineering*. 2016; 10(6): 437-442. doi: 10.15866/ireme.v10i6.9395
- [7] Choudhary AK, Bhushan G. Finite Element Analysis of an Excavator Arm using CAE Tool. *International Journal of Scientific & Engineering Research*. 2017; 8(4): 1058-1063.
- [8] Patil NS, Malbhage VM. FEA Analysis and Optimization of Boom of Excavator. *International Conference on Ideas, Impact and Innovation in Mechanical Engineering*. 2017; 5 (6): 625-632.
- [9] Gurbet Z. Investigation of High-Strength Steel Usage in Cukurova 885 Model Backhoe Loader Boom and Stick [thesis]. Cukurova University; 2023.
- [10] Cheah LW. Cars on a Diet: The Material and Energy Impacts of Passenger Vehicle Weight Reduction in the U.S. [thesis]. Massachusetts Institute of Technology; 2010.
- [11] Taskaya S, Taskaya S. Investigation of Static Structure Effect According to Axial Coordinates by Using Finite Element Method in Ansys Workbench Software of AISI 310 Austenitic Stainless Cylindrical Model Steel. *International Journal of Scientific Engineering and Science*. 2018; 2(11): 65-70. doi: 10.5281/zenodo.2538535
- [12] Gurbet Z, Karacor B, Ozcanli M. Investigation of Bucket Teeth Stress-Deformation Distribution by Using Ultra High Strength Material. 6th International Mediterranean Science and Engineering Congress (IMSEC 2021); 2021; Antalya, Türkiye.
- [13] Guler MS, Sen S. Sonlu Elemanlar Yontemi Hakkinda Genel Bilgiler. *Ordu Universitesi Bilim ve Teknoloji Dergisi*. 2015; 5(1): 56-66.
- [14] Ghassemieh E. Materials in Automotive Application, State of the Art and Prospects. *New Trends and Developments in Automotive Industry*. 2011; 365-394. doi: 10.5772/13286
- [15] Karacor B, Hukumdar O, Akdagcık D, Ozcanli M. Evaluation of Ultra-High Strength Materials in Heavy Truck Chassis. 6th International Mediterranean Science and Engineering Congress (IMSEC 2021); 2021; Antalya, Türkiye.
- [16] Bhaveshkumar PP, Jagdish MP. Structural Optimization of Mini Hydraulic Backhoe Excavator Attachment Using FEA Approach. *Machine Design*. 2013; 5(1): 43-56.
- [17] Simsek A. Bir İş Makinesi Kabininin Modal Analizi [thesis]. Sakarya University; 2010.
- [18] Ozcan FA. Bir Kazici Yükleyici Makinenin Kazici Kolunun Yapısal Optimizasyonu [thesis]. Gazi University; 2023.
- [19] Katmer MC, Bicer SG. Yükleyici İş Makinelerinde Z-Bar Tasarımı ve Yapısal Analizi. *Orclever Proceedings of Research and Development*. 2022; 1(1): 120-129. doi: 10.56038/oprd.v1i1.147
- [20] Bhaveshkumar PP, Jagdish MP. A Review on FEA and Optimization of Backhoe Attachment in Hydraulic Excavator. *IACSIT International Journal of Engineering and Technology*. 2011; 3(5): 505-511. doi: 10.7763/IJET.2011.V3.277
- [21] Bicer G, Katmer MC. Study on the Flexible Dynamic Analysis of the Wheel Loader Under Working Conditions and Comparison with Static FEA Results. *Engineering Perspective*. 2023; 3: 57-62. doi: 10.29228/eng.pers.72736
- [22] Kocakulak T, Thallapalli V, Kiyakli AO. Modeling of an Electric Tractor and Determining Energy Consumption Values in Different Duties. *Engineering Perspective*. 2023; 3: 79-85. doi: 10.29228/eng.pers.51651
- [23] Livatyali H, Yel A. Modeling Simulation and Validation of a Tractor Wet Clutch Controlled by Proportional Valve. *International Journal of Automotive Science and Technology*. 2021; 5(1): 8-18. doi: 10.30939/ijastech..797276
- [24] Sen N, Civek T, Tongu E. Assessment of Conical Die Deep Drawing Ability of DP800 and MART1400 Advanced High Strength Steels. *International Journal of Automotive Science and Technology*. 2023; 7(2): 104-111. doi: 10.30939/ijastech..1278573