

Elliptic Filter Based Noninvasive Blood Pressure Analyze with LabVIEW

Duygu KAYA, Mustafa TÜRK, Turgay KAYA

Firat University, Department of Electrical and Electronics Engineering, Elazığ /Turkey
dgur@firat.edu.tr

(Geliş/Received: 20.02.2017; Kabul/Accepted: 18.04.2017)

Abstract

The blood in the vein is called blood pressure or tension. It depends on the amount of blood pumped by the heart and the resistance of the vessels to this flow and the flexibility of the arterial walls. Very low values than optimum blood pressure and very high values than normal blood pressure are important. With this aim, Noninvasive Blood Pressure Analyze with LabVIEW offers an insight into us. LabVIEW is a graphical programming language that uses a Dataflow model instead of sequential lines of text code. LabVIEW runs principle of Data flow programming that allows multiple operations to work in parallel. So, designers spend less time than a text based programming language. Application areas such as signal processing, image processing and Data analysis are available. In this paper, LabVIEW- based Noninvasive Blood Pressure Analyze (NIBP) using different Data and to obtain systolic/diastolic pressure. As a result of this, the current data are divided into optimum blood pressure, normal blood pressure and prehypertension

Key Words: Blood Pressure; Elliptic Filter; LabVIEW.

LabVIEW ile Eliptik Filtre Tabanlı Noninvaziv Kan Basıncı Analizi

Özet

Damarlardaki kan, kan basıncı ya da tansiyon olarak isimlendirilir. Kan basıncı, kalp tarafından pompalanan kan miktarına ve damarların bu akışa karşı göstermiş oldukları dirence ve arter duvarların esnekliğine bağlıdır. Optimal kan basıncından çok düşük değerler ve normal kan basıncından çok yüksek değerler önem arz etmektedir. Bu amaçla, LabVIEW ile noninvaziv kan basıncı analizi, bize bu konu hakkında fikir sunmaktadır. LabVIEW, ardışık metin kodları yerine veri akışı modelini kullanan bir grafik programlama dilidir. LabVIEW, çoklu işlemlerin paralel çalışmasına olanak tanıyan veri akışı programlama ilkesine göre çalışmaktadır. Bu nedenle, tasarımcılar metin tabanlı bir programlama dilinden daha az zaman harcamaktadırlar. Sinyal işleme, görüntü işleme ve veri analizi gibi uygulama alanlarında kullanılmaktadır. Bu çalışmada farklı veriler kullanarak sistolik / diyastolik basınç elde etmek için LabVIEW tabanlı non-invaziv kan basıncı analizi (NIBP) kullanılmıştır. Yapılan çalışma sonucunda mevcut veriler, optimum kan basıncı, normal kan basıncı ve prehipertansiyona bölünür.

1. Introduction

Blood Pressure (BP) is the pressure that the blood in the vein bed makes to the vein walls during the flow. It depends on the amount of blood pumped by the heart and the resistance of the vessels to this flow and the flexibility of the arterial walls [1]. As the heart contracts, blood is pumped into the arteries. This increases the pressure in the arteries, while the pressure decreases in the heartbeats. As a consequence of this, the BP is indicated by two values, namely systolic pressure and diastolic pressure and the unit is millimeters of mercury (mmHg) [2]. With

BP measurement, it is decided which characteristics the person exhibits from optimum, normal, hypertension, hypotension and prehypertension. The optimum BP is below 120/80 mmHg. The normal BP is below 130/85 mmHg. Hypertension is higher than normal accepted values and one of the most important health problems. The BP is above 140/90 mmHg. Hypertension can lead to headache, dizziness, and can lead to heart-kidney disorders, paralysis and visual disturbances if not noticed. Hypotension is abnormally low BP that is 90/60 mmHg below. It can occur due to

many reasons such as sadness, stress, long-term hunger and vitamin deficiency. But every low BP not indicate a health problem. Prehypertension is used to describe patients whose BP is elevated but still within normal limits. The BP is between 120-139 mmHg systolic and 80-89 mmHg diastolic [3]. BP monitors should be considered to prevent serious illnesses and situations that could cause life-threatening injuries. The aim of this paper to investigate LabVIEW- based Noninvasive Blood Pressure Analyze (NIBP) using different Data and to obtain systolic/diastolic pressure. As a result of this, the current Data are divided into optimum pressure, normal pressure and prehypertension.

The structure of this paper is as follows: Second section includes preprocessing of signals, database signals taken from LabVIEW. Third section includes evaluation of results. The last section includes conclusion and future works.

2. Material and Methods

A. Database

Signals required for paper are taken from the LabVIEW own Database. Signals of three Databases that are NIBP_Data_1, NIBP_Data_2, NIBP_Data_3 were used to examine. Each signal is sampled at intervals of 0.002 for 31, 32, 27 seconds, respectively. These signals correspond to prehypertension, normal and optimal respectively.

B. LabVIEW

LabVIEW is a graphical programming language that uses a Dataflow model instead of sequential lines of text code. Comparison of the other language, LabVIEW runs principle of Data flow programming that allows multiple operations to work in parallel [4,5]. It provides that acquires of

bioelectrical signal, preprocesses and analyzes them.

LabVIEW is a software based graphical programming language that consists of front panel and block diagram. The sections where the user interface prepares and the code is written correspond to front panel and block diagram, respectively. The block diagram of designed system is shown in Figure 1. LabVIEW is called a Virtual Instrument (VI) because it resembles the physical instruments used in the laboratory with the way it works [6]. The biomedical workbench toolkit in LabVIEW allows applications such as recording, by sensor with DAQ hardware, and viewing bioelectrical signal, heart rate variability (HRV) analysis, ECG Feature Extracture and Noninvasive Blood Pressure Analyze By file format converter, the files are converted into different types of file formats for the various applications. For instance, it supports .hea, .tdms, .mat, .rec extensions file [7]. In this paper, .tdms extensions file was used.

C. Preprocessing

Used signals are recorded with many low frequency undesired noise caused by the circulatory system. Filtering should be done to suppress them. For this, lowpass elliptic filter was chosen. An elliptic filter is a signal processing filter with equalized ripple behavior in both the passband and the stopband [8]. The level of ripple on each band is a configurable filter. As the ripple in the pass-band approaches zero, the filter becomes a Chebyshev type II filter, as the ripple in the stopband approaches zero, it becomes a Chebyshev type I filter and both band approaches zero, filter becomes a Butterworth filter. Although this filter has ripple both band, it has a rapid decline from the pass band to the stop band. With this filter, undesired signals removed then with BP analyzer systolic/diastolic and mean arterial pressure (MAP) were obtained.

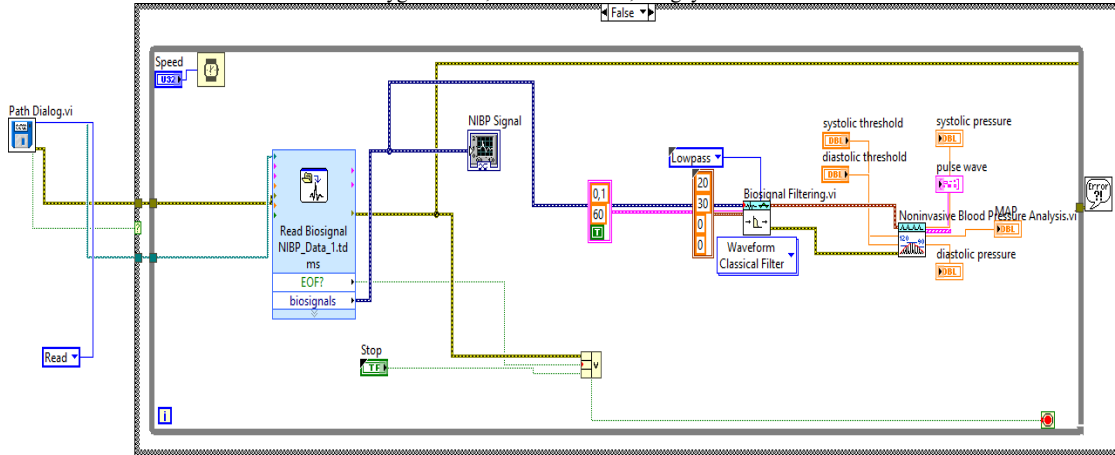

Fig.1 Block diagram of designed system

3. Results and Discussion

Mentioned techniques have been applied to BP signals to obtain systolic/diastolic BP and MAP value. In order to interpret the results obtained, the values that the World Health Organization (WHO) prescribes for BP limit values are taken as references. The classification of BP by the World Health Organization International Hypertension Committee is given in Table 1. Obtained BP results are shown in Table 2.

Figure 2 shows NIBP_Data_1, Figure 3 shows the result of the analysis, Figure 4 shows the NIBP_Data_2, Figure 5 shows the analysis result, Figure 6 shows the NIBP_Data_3, and Figure 7 shows the analysis results.

Obtained results show that NIBP_Data_1 corresponds to prehypertension, NIBP_Data_2 corresponds to normal BP and NIBP_Data_3 corresponds to optimal BP.

Table 1. Classification of BP

Category	systolic, mmHg	diastolic, mmHg
Hypotension	< 90	< 60
Normal	< 130	< 85
Optimal	< 120	< 80
Prehypertension	130-139	85-89
Stage 1 hypertension	140- 159	90-99
Stage 2 hypertension	160-169	100-109

Table 2. Obtained BP Results

Category	systolic, mmHg	diastolic, mmHg	MAP mmHg
NIBP_Data_1	131	86	93
NIBP_Data_2	122	72	83
NIBP_Data_3	107	64	72

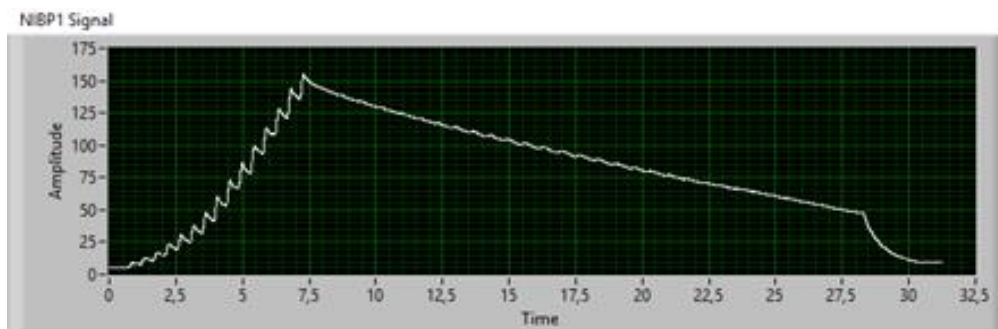

Fig.2 NIBP_Data_1 Signals

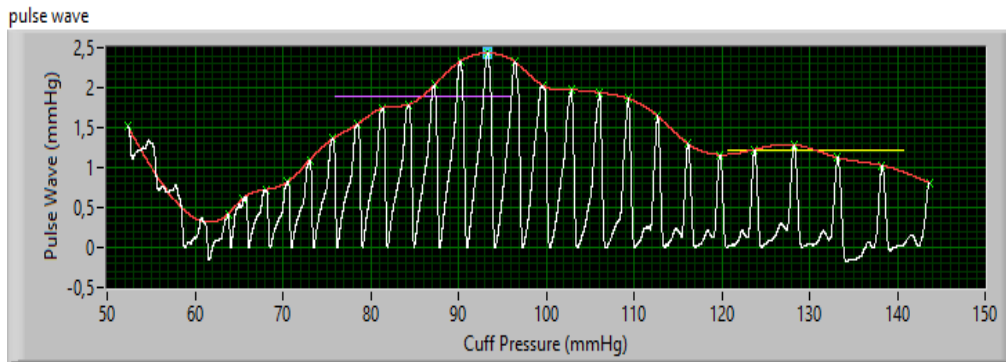

Fig.3 Analyze results of NIBP_Data_1 Signals

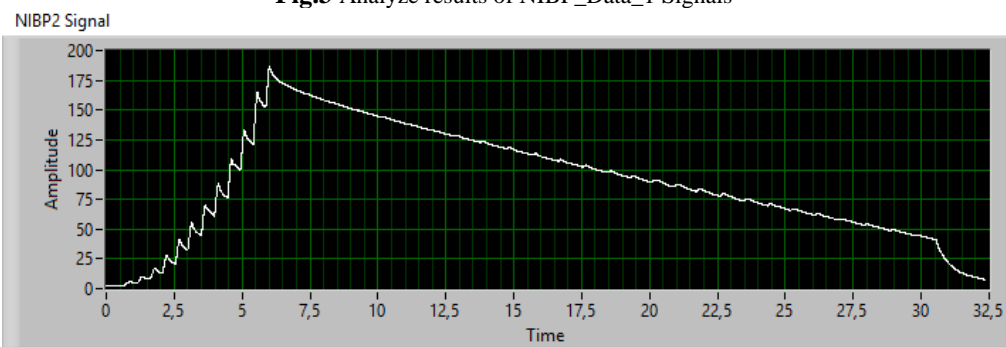

Fig.4 NIBP_Data_2 Signals

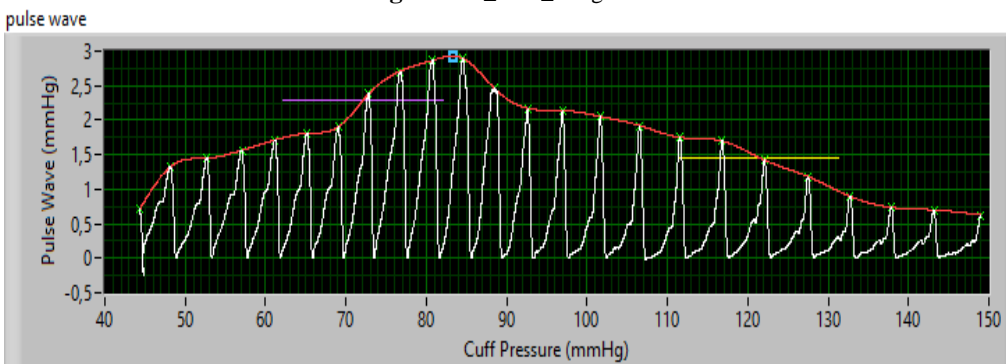

Fig.5 Analyze results of NIBP_Data_2 Signals

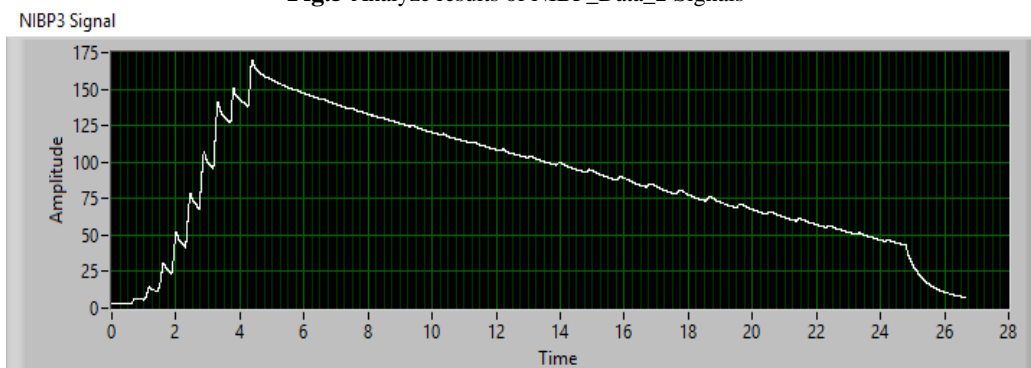

Fig.6 NIBP_Data_3 Signals

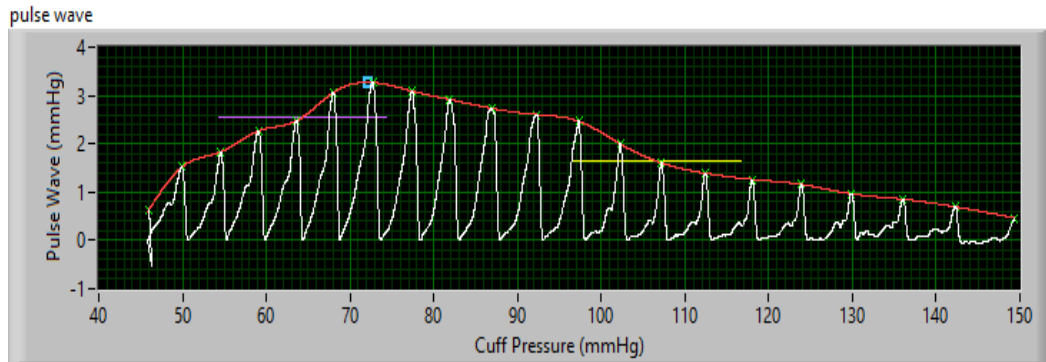

Fig. 7 Analyze results of NIBP_Data_3 Signal

4. Conclusions

Low BP and high BP are important health problems. Especially, hypertension is one of the most important health problems in the world that requires regular checking. Prehypertension is used to describe patients whose BP is elevated but still within normal limits. The optimum BP is below 120/80 mmHg. People with pre-hypertension are more likely to have a risk of myocardial infarction and fallacies than people with normal BP. The normal BP is below 130/85 mmHg. Hypotension is abnormally low BP that is 90/60 mmHg below. It can occur due to many reasons such as sadness, stress, long-term hunger and vitamin deficiency.

So, in this study, it is provided to measure BP level with the developed LabVIEW algorithm. Simple usage of graphical structure allows to observe BP level to the doctor or the patients. In future studies, classification models will be tried to be improved.

5. References

1. Ogedegbe, G., Pickering, T., (2010). Principles and techniques of blood pressure measurement. *Cardiology Clinics*. **28** (4), 571–586.
2. Obrien, E., (2001). Blood pressure measurement is changing *Heart*. **85** (1): 3–5. doi:10.
3. Materson, B.J., Garcia-Estrada, M., Degraff, S.B., Preston, R.A., (2017). Prehypertension is Real and Can be Associated with Target Organ Damage, *Journal of the American Society of Hypertension*, doi.org/10.1016/j.jash.2017.09.005
4. Kehtarnavaz, N, Mahotra, S., *Digital Signal Processing Laboratory: LabVIEW-Based FPGA Implementation*, pp.7.
5. Aydın, S.G., Kaya, T., Güler, H., Wavelet-based study of valence–arousal model of emotions on EEG signals with LabVIEW, *Brain Informatics*, (3), pp.1-9.
6. <http://www.ni.com/white-paper/4752/en/>
7. Deshmukh, A., Gandole, Y., (2015). ECG Feature Extraction Using NI Lab-View Biomedical Workbench. *International Journal of Recent Scientific Research* 6(8), pp.5603-5607.
8. Daniels, R.W., *Approximation Methods for Electronic Filter Design*. New York: McGraw-Hill.