



POLİTEKNİK DERGİSİ

JOURNAL of POLYTECHNIC

ISSN: 1302-0900 (PRINT), ISSN: 2147-9429 (ONLINE)

URL: <http://dergipark.org.tr/politeknik>



An approach based on golden eagle optimization algorithm for maximum power point tracking of pv panel under partial shading conditions

Kısmi Gölgeleme Koşulları Altında PV Panelinin Maksimum Güç Noktası Takibi İçin Altın Kartal Optimizasyon Algoritmasına Dayalı Bir Yaklaşım

Yazar(lar) (Author(s)): Waleed Mohammed M Aburas¹, Necmi Serkan Tezel²

ORCID¹: 0000-0003-4479-938x

ORCID²: 0000-0002-9452-677x

To cite to this article: Aburas W. M. M. ve Tezel N. S., “An Approach Based On Golden Eagle Optimization Algorithm for Maximum Power Point Tracking Of Pv Panel Under Partial Shading Conditions”, *Journal of Polytechnic*, *(*) : *, (*).

Bu makaleye şu şekilde atıfta bulunabilirsiniz: Aburas W. M. M. ve Tezel N. S., “An Approach Based On Golden Eagle Optimization Algorithm for Maximum Power Point Tracking Of Pv Panel Under Partial Shading Conditions”, *Politeknik Dergisi*, *(*) : *, (*).

Erişim linki (To link to this article): <http://dergipark.org.tr/politeknik/archive>

DOI: 10.2339/politeknik.1451381

An Approach Based on Golden Eagle Optimization Algorithm for Maximum Power Point Tracking of PV Panel Under Partial Shading Conditions

Highlights

- ❖ The GEO algorithm is inspired by the hunting behavior of golden eagles to overcome challenges in traditional MPPT techniques.
- ❖ The GEO MPPT technique has been tested through simulations in three partial shading scenarios.
- ❖ The performance of the GEO algorithm has been compared with GA and PSO.

Graphical Abstract

This graphical illustrates a solar energy system enhanced with Maximum Power Point Tracking (MPPT), utilizing a bio-inspired optimization approach (Golden Eagle Optimization) for efficient energy management and conversion.

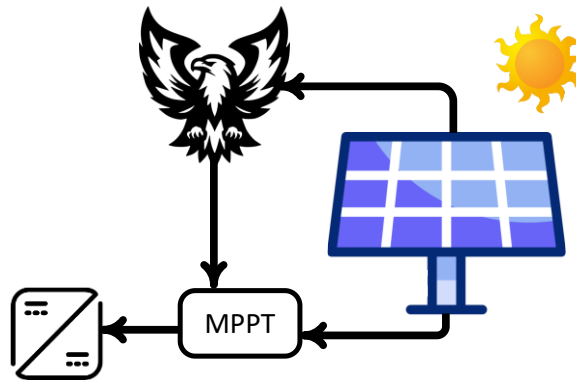

Figure. Graphical Abstract

Aim

The study aims to develop and validate an innovative Maximum Power Point Tracking (MPPT) technique using the Golden Eagle Optimization (GEO) algorithm. This method is designed to accurately determine the global maximum power point (GMPP) to improve the efficiency of photovoltaic (PV) systems under partial shading conditions.

Design & Methodology

Inspired by the hunting behavior of golden eagles, the GEO algorithm is used to address the limitations of traditional MPPT techniques. The effectiveness of the algorithm is verified through simulations in three different partial shading scenarios. The comparative analysis highlights the superior performance of the algorithm in terms of convergence speed, accuracy and robustness compared to other meta-heuristics such as Genetic Algorithm (GA) and Particle Swarm Optimization (PSO).

Originality

This paper presents the GEO algorithm as an innovative approach for MPPT and highlights its simplicity, adaptability and superior performance compared to conventional and existing meta-heuristic algorithms.

Findings

The GEO algorithm showed a 10% improvement in tracking efficiency and a 20% speedup in convergence time compared to GA and PSO under partial shadowing conditions. Its simplicity and the need for minimal computational resources make it highly suitable for real-time MPPT applications.

Conclusion

The study highlights the potential of the GEO algorithm to improve PV system performance under partial shading conditions. By improving energy extraction efficiency and reducing convergence time, the GEO-based MPPT technique contributes to the wider adoption of solar energy as a reliable and sustainable power source.

Declaration of Ethical Standards

The author(s) of this article declare that the materials and methods used in this study do not require ethical committee permission and/or legal-special permission. / The author(s) of this article declare that the materials and methods used in this study do not require ethical committee permission and/or legal-special permission.

An Approach Based on Golden Eagle Optimization Algorithm for Maximum Power Point Tracking of PV Panel Under Partial Shading Conditions

Araştırma Makalesi / Research Article

Waleed Mohammed M ABURAS¹, Necmi Serkan TEZEL²

¹Department of Electrical and Electronics Engineering, Karabuk University, Karabuk, Türkiye

²Department of Electrical and Electronics Engineering, Karabuk University, Karabuk, Türkiye

(Geliş/Received : 12.03.2024 ; Kabul/Accepted : 15.11.2024 ; Erken Görünüm/Early View : 16.01.2025)

ABSTRACT

This study introduces an innovative Maximum Power Point Tracking (MPPT) technique utilizing the Golden Eagle Optimization (GEO) method, specifically designed to enhance the efficiency of photovoltaic (PV) systems under partial shading conditions. Unlike traditional MPPT approaches that struggle with local peaks in power-voltage curves caused by shading, the GEO method leverages the hunting behavior-inspired algorithm to accurately locate the global maximum power point (GMPP). The effectiveness of the GEO MPPT technique is demonstrated through extensive simulations across three diverse case scenarios, each representing different partial shading patterns. In all scenarios, the GEO method outperforms conventional MPPT techniques, showcasing its adaptability and superior performance in challenging conditions. The successful implementation of GEO MPPT leads to substantial improvements in PV panel energy extraction efficiency, even when faced with the complexities of partial shading. This research contributes significantly to the advancement of solar PV systems, enhancing their reliability and performance in real-world environments. By mitigating the impact of partial shading, this work promotes the wider adoption of solar energy as a viable and sustainable power solution.

Keywords: Golden Eagle Optimization Algorithm, Maximum Power Point Tracking, PV Panel, Partial Shading Conditions

1. INTRODUCTION

The increasing global population demands more electricity, but traditional energy sources are dwindling. This necessitates a shift to renewable energy, which is now accessible and competitively priced [1]–[4]. PV generation is key due to its benefits, but its lower efficiency and reliance on temperature and radiation present challenges [5]–[7]. MPPT algorithms, like Perturb and Observe (P&O), have been developed to optimize PV power [8]. However, P&O has limitations, and artificial intelligence-based algorithms like ANFIS have been proposed to improve tracking [9]–[13]. This paper suggests using the GEO algorithm for MPPT under partial shading [14]. Inspired by the foraging behavior of golden eagles, the GEO algorithm offers a unique solution to accurately pinpoint the global maximum power point (GMPP) even under partial shading conditions [15]. Simulations show GEO outperforms conventional MPPT methods, enhancing PV energy extraction and supporting the adoption of solar energy. Table 1 provides indispensable citations to assist readers in grasping crucial terms utilized throughout the paper. Fossil fuels contribute to climate change, making renewable energy crucial. However, the intermittent nature of renewable energy sources (RESs) poses challenges for electricity network operators in terms of reliability and economic viability for electricity-generating companies [16]–[19]. Utilizing prevailing and well-established technology in energy generation context PV systems exhibit excellent performance in both serial and parallel configurations [20]–[22]. The basic solar

panel constitutes a vital element of the solar energy provision setup, meticulously engineered to operate without environmental emissions or additional components [23]. Metaheuristic algorithms are optimization techniques designed to quickly search large search spaces and find near-optimal solutions [24], [25][26][27][28]. Population-based metaheuristic algorithms often utilize swarm intelligence or bio-inspired algorithms. Deterministic methods such as P&O are commonly paired with metaheuristic algorithms [25], [29]–[31]. Although metaheuristic algorithms select the best available option at any given moment, they may yield poor results under partial shading conditions (PSCs) because they do not consider alternative options or future consequences. While improved metaheuristic algorithms have been proposed for PSCs, such as those mentioned in [32]–[34], they still face challenges including computational burden, steady-state oscillations, and difficulty in escaping poor solutions. Typically, these methods require prior knowledge of P-V or power-current (P-I) characteristics to function effectively under PSCs. Artificial neural networks (ANNs) are commonly used in AI approaches for MPPT construction [9], [35]–[38]. ANNs consist of layers of neurons that adjust their parameters using optimization algorithms like gradient descent to understand the relationship between inputs and outputs. However, these algorithms may demand significant computational resources and extensive data for training [39], [40]. The Simulated Annealing (SA) algorithm, developed by Lyden for MPPT tracking [37], is an example of a single-

* (Corresponding Author)

e-posta : waleed.aburas2018@gmail.com

solution metaheuristic algorithm. However, SA may take time to produce the final result if the cooling process is delayed. Particle Swarm Optimization (PSO) was one of the first population-based metaheuristic algorithms implemented for MPPT [38]. Despite its widespread use in addressing PSC issues, PSO suffers from long settling times and persistent fluctuations in PV output power during tracking. Consequently, additional population-based metaheuristic algorithms have been proposed for MPPT. One approach involves integrating a metaheuristic algorithm with a deterministic approach (DA), such as the P&O method, to combine their strengths and pinpoint the GMPP during tracking. For example, Lian et al.[41] suggested a hybrid technique that merges P&O and PSO. To assign the nearest local peak, the P&O technique is initially used. Afterwards, the PSO approach is used to look for GMPP moving forward. Proposed a hybrid technique that combines P&O and PSO. Initially, the P&O technique is used to identify the nearest local peak, followed by the use of PSO to search for GMPP. Ishaque et al.[42] suggested an enhanced MPPT technique incorporating a modified PSO algorithm, while Makhloufi et al. [43] used a logarithmic PSO approach to speed up convergence without reducing the search window. Millah [44] enhanced the performance of the grey wolf optimization (GWO) algorithm by adding pouncing behaviors and additional weighting criteria. Teshome et al. [45] modified the firefly algorithm (FA) to reduce tracking time and the number of operations per cycle. Research on MPPT using metaheuristic algorithms underscores the need for a comprehensive understanding of optimization issues.

stooping behavior exhibited by golden eagles, the proposed approach incorporates this behavior, mimicking the genuine hunting behavior of golden eagles. Experiments conducted in various static and dynamic scenarios validate the proposed technique. Table 1 provides a comprehensive review and comparison of previous studies investigating MPPT using various algorithms. The table presents a comparative analysis of diverse optimization algorithms utilized for MPPT in PV systems. Each algorithm is assessed for its benefits, compared with other methods, drawbacks, and outcomes. Algorithms such as DOA, BOA, FA, FPA, GWO-PSO, and GEO are examined, outlining their advantages and limitations in enhancing MPPT efficiency across different scenarios. Despite showing potential, further validation in actual PV systems and investigation in unexplored situations is crucial for thorough evaluation and practical application. The GEO approach, inspired by the hunting behaviors of golden eagles, is a robust optimization strategy widely applicable across various domains, demonstrating superiority over other metaheuristic methods like Genetic Algorithm (GA) and PSO in terms of convergence speed[51], [52]. Its effectiveness, simplicity, adaptability, and robustness make it a valuable tool for addressing complex optimization challenges, offering a thorough exploration of optimal solutions while avoiding local optima[51], [53]. Particularly, in optimizing photovoltaic systems under partial shade conditions, GEO proves pivotal, as showcased through detailed analyses of optimization outcomes for both series- and parallel-connected PV panel configurations.

Table 1. Comparison of previous research

Ref	Algorithm	Advantages	Comparison of Methods	Disadvantages	Result
[46]	DOA	The implementation of the DOA markedly reduces convergence time and failure rates compared to other modern MOAs, enhancing MPPT efficiency in critical scenarios with partial shade PV systems.	MCA, PSO, GWO	The research predominantly relies on simulated results, requiring validation in real-world PV systems to confirm DOA's practical efficacy. While DOA shows promise in decreasing convergence time and failure rates, further exploration and testing are needed to evaluate its performance comprehensively, especially in unexplored scenarios.	The study presents the DOA as a superior method for optimizing MPPT in PV systems under partial shade, offering faster convergence time (0.4 seconds) and zero failure rate compared to other MOAs, indicating its effectiveness for challenging conditions.
[47]	BOA	The utilization of the Butterfly Optimization Algorithm (BOA) presents a notable enhancement in tracking precision and speed within partially shaded PV arrays, presenting a viable solution for real-time applications.	GWO, PSO, GSA	BOA's efficacy could be subject to variation based on system configurations and environmental factors, necessitating thorough validation and testing in real-world PV setups to evaluate its performance comprehensively and address any practical implementation challenges or limitations.	The BOA outperformed GWO, PSO-GSA, and GSA, exhibiting higher accuracy, faster tracking speed (34.36% faster than GWO, 43.84% faster than PSO-GSA), and enhanced efficiency with reduced statistical metrics (STD, RMSE, MAE, RE) in three insolation scenarios studied.

Table 1 (Cont.). Comparison of previous research

Ref	Algorithm	Advantages	Comparison of Methods	Disadvantages	Result
[48]	FA	The FA demonstrates accurate MPP tracking, improved performance parameters (convergence and tracking speed), and enhanced tracking efficiency, leading to the maximization of energy recovery from solar systems.	P&O, PID, PSO	Further validation in real-world PV systems is required to comprehensively assess the effectiveness of the FA method, which shows promise in addressing transient scenarios and outperforming PSO, but requires further exploration in unexplored conditions, particularly under partial shading, suggesting the necessity for additional research and development to integrate parameters like humidity and wind. The effectiveness of the FPA method is mainly evaluated using simulations and experiments, emphasizing the need for real-world validation across diverse environmental conditions. Further research is required to assess its performance in unexplored scenarios, while an exclusive focus on income generation analysis in real-time conditions may limit its generalizability, requiring cautious interpretation.	The FA outperforms other methods, exhibiting superior efficiency, quicker resolution of transient situations, and simpler parameter tuning, leading to successful MPPT in both normal and partial shading conditions, significantly improving overall efficiency and energy recovery from solar PV arrays.
[49]	FPA	The FPA effectively identifies the global peak under strong shading, offering swift convergence and adaptability for MPPT in solar PV systems. Its dual-mode search introduces crucial randomness, enhancing performance in critical shade scenarios, while its simplicity makes it a practical solution.	PSO, P&O		The FPA demonstrates superiority in all tested cases, confirming its effectiveness as an MPPT method for solar systems under various irradiated conditions, leading to increased energy harvest and income generation.
[50]	GWO-PSO	The hybrid MPPT method, integrating GWO and PSO, outperforms conventional techniques like P&O and incremental conductance, offering improved tracking precision, faster convergence to the GMPP, and greater efficiency. With simplicity and robustness, it requires only two control parameters, ensures GMPP attainment regardless of initial conditions, and doesn't mandate prior knowledge of PV array characteristics, simplifying implementation across various PV systems, irrespective of grid connection status.	GWO, PSO, P&O	The hybrid GWO-PSO-based MPPT method, while potentially resource-intensive due to co-simulation, shows promise based on simulation results, but real-world validation is needed for varied environmental conditions. However, its performance in unexplored scenarios remains uncertain and warrants further investigation.	The hybrid GWO-PSO-based MPPT technique demonstrates superior tracking accuracy, faster convergence to the GMPP, and higher performance compared to alternative strategies (GWO, PSO, and P&O), highlighting its simplicity, flexibility, and reduced control parameters without requiring prior knowledge of solar system characteristics.
[15]	GEO with stooping behavior	Incorporating stooping behavior into the GEO algorithm improves tracking accuracy and reduces duration, requiring just one extra parameter for implementation. Compared to other MHAs like PSO, GWO, and BA, the proposed method demonstrates superior dynamic tracking precision.	GEO, PSO, GWO, BA	While the proposed method shows advancements over existing MHAs, it may still have limitations in unexplored scenarios. Moreover, integrating stooping behavior could complicate the algorithm, impacting its real-world usability. Further validation in actual PV systems is necessary due to the study's reliance on simulated data.	The proposed method surpasses GEO, reducing tracking time by 42.41% on average. In comparison to PSO, it saves an average of 18.52% of the tracking time. Across various dynamic scenarios, the proposed algorithm improves dynamic tracking accuracy by 1.95%, 2.66%, 3.56%, and 4.24% when compared to GEO, PSO, GWO, and BA, respectively.

2. PROBLEM DEFINITION

The paper proposes a novel approach using the Golden Eagle Optimization (GEO) Algorithm for Maximum Power Point Tracking (MPPT) in solar PV systems affected by partial shading. The GEO refines the search process to precisely identify the global maximum power point (GMPP) even under challenging shading conditions.

The duty cycle represents the ratio of the pulse duration to the period duration [54], [55]. It's expressed as a ratio from 0 to 1 or 0 to 100%, signifying the proportion of on-time to the total cycle time. This concept is clarified within the context of ideal pulses, resulting in the creation of a square wave.

$$D = \frac{PW}{T} \times 100\% \quad (1)$$

Similarly, a duty cycle can be expressed as:

$$D = \frac{PW}{T} \quad (2)$$

A symmetrical pulse is generated with a 50% duty factor, while an asymmetrical pulse results when the pulse width equals half the period. The term "duty factor" can encompass both the duty cycle and its reciprocal, indicating the ratio of the pulse duration to the pulse interval [56]. Adjusting the duty cycle provides a digital method to regulate electrical voltage and power. PWM generates a continuously adjustable DC voltage. Following PWM circuitry, demodulation results in voltage averaging. Despite the on-off switching, an analog signal is produced due to the variable duty cycle. Phase-cut control utilizes a variable duty cycle of sinusoidal voltage to regulate motor speeds. For the buck-boost converter, each duty cycle is received, and the corresponding MPP is calculated and stored. This process continues until the GEO algorithm reaches an optimal duty cycle, considering factors like temperature and irradiance variations. Figure 1 illustrates the DC-DC buck-boost converter.

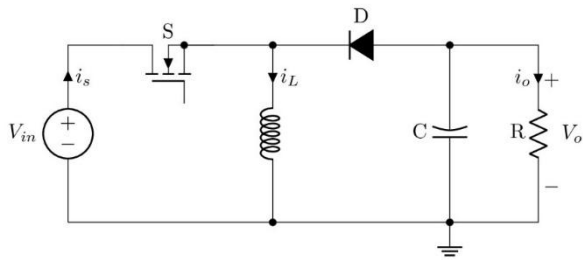

Figure 1. DC-DC buck-boost converter

The electrical model of a solar panel with a single diode is depicted in Figure 2. By ignoring the shunt resistance, the output current can be represented as shown in Equation (3). The photocurrent of a solar module is determined by Equation (4). When the photocurrent is higher than the output current, the output voltage can be described as shown in Equation (5). If the photocurrent is less than the output current, the output voltage is represented as shown in Equation (6).

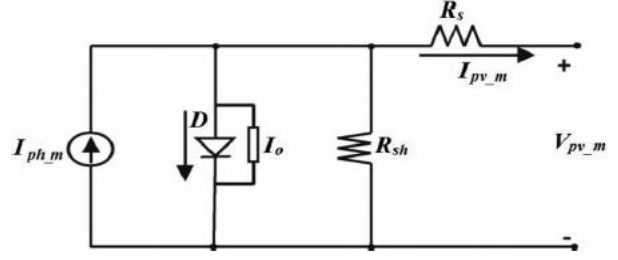

Figure 2. solar panel with single diode

$$I_{pv_m} = I_{ph_m} - I_o \left[\exp\left(\frac{V_{pv_m} + R_s I_{pv_m}}{V_t}\right) - 1 \right] \quad (3)$$

The following equation is applied to determine the photocurrent, I_{ph_m} , of a solar module:

$$I_{ph_m} = (I_{sc_N} + k_i \Delta T) \lambda \quad (4)$$

when I_{ph_m} is higher than I_{pv_m} , the output voltage of solar panel V_{pv_m} can be described as:

$$V_{pv_m} = V_t \left[\ln\left(\frac{I_{ph_m} - I_{pv_m}}{I_0}\right) + 1 \right] - R_s I_{pv_m} \quad (5)$$

If I_{ph_m} is less than I_{pv_m} , the V_{pv_m} can be represented as.

$$V_{pv_m} = 0 \quad (6)$$

Which

$$\Delta T = T - T_N \quad (7)$$

$$V_t = \frac{nkT_N s}{q} \quad (8)$$

$$R_s = - \left. \frac{\partial V_{pv_m}}{\partial I_{pv_m}} \right|_{V_{oc_N}} - \frac{1}{XV} \quad (9)$$

$$XV = \frac{I_0 \exp\left(\frac{V_{oc_m}}{V_t}\right)}{V_t} \quad (10)$$

$$V_{oc_m} = V_{oc_N} + V_t \ln(\lambda) + k_v \Delta T \quad (11)$$

The objective function guides the optimization process by defining it as the inverse of the average power output of the PV system. Minimizing this cost function corresponds to maximizing the power output, aiming to achieve maximum energy extraction efficiency under partial shading conditions. The cost function for modules is expressed as $Z = 1/P$, where obtaining the inverse of the average power is crucial for determining the maximum power value. This cost function is inversely proportional to the average power, serving as a measure of solution quality in the optimization algorithm. The GEO algorithm continually seeks the smallest value for the boost converter before reaching maximum power output, with the duty cycle symbolizing the GEO algorithm's core. According to this equation, high power yields low Z , resulting in minimal cost. The specified parameters include the upper bound (0, 1), and lower bound (0.9) for both the GEO and the population of the GEO. The initial population of golden eagles is established, denoted as (n). The fitness value reaches its maximum when the power reaches its peak. The cost function outlined in this paper is defined by the equation in (14):

$$Z = \frac{1}{P} \quad (12)$$

The fitness function is represented as the Cost Function as shown in Equation (13). During the evaluation of

brightness, all golden eagles are directed towards the brighter ones. During the position update, all GEOs are relocated to a more advantageous position.

$$\text{function} = \text{CostFunction} \propto \frac{1}{\text{Power_Average}} \quad (13)$$

3. GOLDEN EAGLE OPTIMIZATION ALGORITHM-BASED MPPT

The GEO algorithm was chosen for this study due to the unique characteristics that make it well-suited for MPPT in PV, especially under partial shading conditions. Inspired by the hunting behavior of golden eagles, the GEO algorithm embodies an effective balance between exploration and exploitation, reflecting the eagle's strategic approach to locating and capturing prey while conserving energy, critical in MPPT, as shown in Figure 3 depicts the observation of attack and cruise vectors in 2D space, with a distinct golden eagle depicted in each variation. This balance ensures thorough exploration of the power-voltage curve to avoid local maxima while efficiently converging on the GMPP.

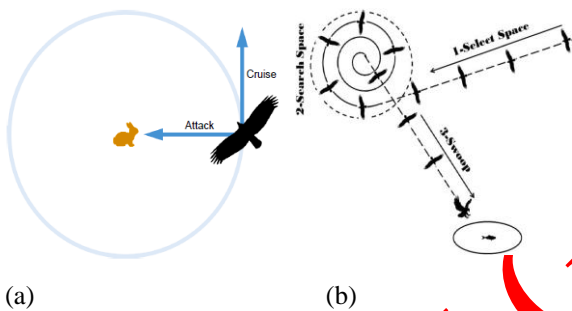

Figure 3. a) Golden Eagles' Spiralling Flight Pattern[53], b) Outcomes for the Three Principal Stages of Hunting [57].

GEO's strengths lie in its robustness and adaptability, demonstrated across various optimization challenges, showcasing its ability to adapt to different scenarios. It offers faster convergence compared to other metaheuristic algorithms like GA and PSO, making it efficient. Despite its powerful optimization capabilities, GEO is relatively simple to implement, requiring minimal parameters and computational resources, making it practical for real-time MPPT in PV systems. Its effectiveness in avoiding local optima and accurately locating the GMPP, even under partial shading conditions, makes it particularly valuable for optimizing PV systems in real-world environments where shading is common. The pseudocode below provides a detailed outline of the GEO algorithm and demonstrates its application in MPPT (Maximum Power Point Tracking) systems.

Algorithm 1: Algorithm: Golden Eagle Optimization (GEO)

Start

Initialization: Set the algorithm parameters:

- Upper bound (UB), Lower bound (LB) for the duty cycle: UB=1, LB=0.9
- Number of iterations (*MaxIter*).
- Number of golden eagles in the population (*n*).
- Randomly initialize the positions of golden eagles (*X*) within the defined [LB, UB].
- Calculate the fitness value for each golden eagle based on the cost function $Z=1/P$, where *P* is the power output.

2. Main Loop: (Repeat until *MaxIter* is reached or convergence occurs)

- **Update Positions of Golden Eagles:**
 - Evaluate the brightness (fitness value) of each golden eagle.
 - Identify the brightest golden eagle (global best).
 - For each golden eagle:

Update its position by simulating the hunting behavior, including:

- **Observation Vector:** Calculate the relative position of prey (optimum duty cycle).
- **Attack and Cruise Behavior:** Adjust the eagle's movement using exploration and exploitation strategies (balancing search space exploration and convergence).
- Ensure the new position lies within the bounds LB and UB.
- **Evaluate Fitness:**
 - Compute the new fitness value *Z* for each golden eagle.
 - If the new fitness is better, update the current position and record the new global best.

3. Stopping Criteria:

- If the global best position corresponds to the desired accuracy (maximum power), or if *MaxIter* is reached, terminate the algorithm.

4. Output:

- Return the optimal duty cycle corresponding to the global best fitness value (*X_{best}*).
- Calculate the maximum power output (GMPP) based on this duty cycle

Stop

While many state-of-the-art optimization algorithms exist, the unique blend of exploration, exploitation, robustness, efficiency, and simplicity makes GEO an attractive choice for MPPT in PV systems. A visual representation of the complete solar system is depicted in Figure 4, showcasing the system's block diagram. Its effectiveness in navigating the complexities of partial shading, as demonstrated through simulations and

comparisons with conventional MPPT techniques, further solidifies its potential as a powerful tool for enhancing the performance and reliability of solar PV systems.

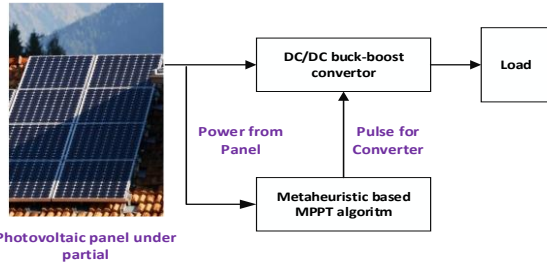

Figure 4. A graphical depiction of the complete solar system.

3.1. The PSO-GA Hybrid Algorithm

The hybrid PSO-GA algorithm begins by initializing parameters for both the PSO and GA components. Firstly, the PSO component generates an initial population of duty cycles for the Buck-Boost converter, evaluating the resulting power output from the PV system and adjusting the duty cycles according to PSO principles. Subsequently, the fittest duty cycles are transferred to the GA component, where crossover and mutation operations further refine them. The updated duty cycles from both PSO and GA are then merged, and the process iterates until either the optimal duty cycle for maximum power point tracking is identified or a maximum number of iterations is reached. The amalgamation of PSO and GA enables the algorithm to harness the strengths of both optimization techniques. PSO excels in exploring the solution space and avoiding local optima, whereas GA is proficient in exploiting and refining solutions through crossover and mutation. By integrating these methods, the PSO-GA hybrid algorithm can effectively seek the optimal duty cycle for MPPT in PV systems across varying irradiance and temperature conditions. To ensure optimal performance in diverse scenarios, specific implementation details such as population size, iteration count, crossover and mutation rates, and selection mechanisms must be meticulously

tuned. Figure 5 illustrates the operation of the hybrid PSO-GA for MPPT in PV.

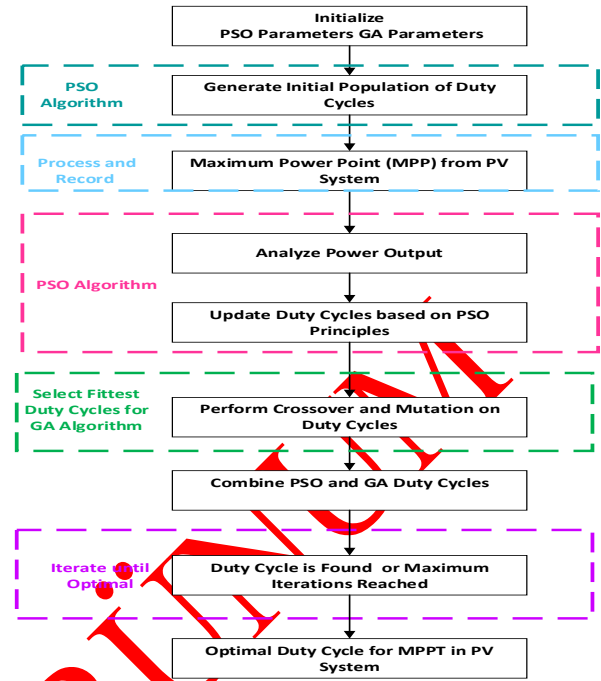

Figure 5. Flowchart Combined PSO-GA for MPPT in PV

4. SIMULATION RESULTS

The simulation studies aimed to explore two distinct scenarios involving partial shading in PV. The objectives were to analyse the performance of series-connected PV panels and parallel-connected PV panels under partial shading conditions.

4.1. Input Parameters

The simulation utilized various parameters, including those specific to the PV panels and the Simulink model. Table 2 provides a comprehensive list of these parameters, encompassing maximum power, cell count, voltage, current, temperature coefficients, and resistances.

Table 2. Parameter definition

Module Data	Value
Maximum Power (W)	220.5
Cells per module (Ncell)	60
Open circuit voltage V_{oc} (V)	36.8
Short-circuit current I_{sc} (A)	8.08
Voltage at maximum power point V_{mp} (V)	30
Current at maximum power point I_{mp} (A)	7.35
Temperature coefficient of V_{oc} (%/deg.C)	-0.3364
Temperature coefficient of I_{sc} (%/deg.C)	0.038465
Light-generated current I_L (A)	8.1108
Diode saturation current I_0 (A)	1.1169e-10
Diode ideality factor	0.9567
Shunt resistance R_{sh} (ohms)	83.699
Series resistance R_s (ohms)	0.3192

Table 3 gives a summary of the operational parameters for each algorithm in this study. These parameters include population size, mutation rate, crossover rate, and other algorithm-specific configurations.

Each of these settings has a great impact on the performance and efficiency of the algorithms, ensuring optimal results that are appropriate for the objectives of the study.

Table 3. Parameters of the Compared Algorithms

Algorithm	Population Size (n)	Number of Iterations (MaxIter)	Specific Parameters
GEO	20	100	Observation vector adjustment, Attack/cruise behavior, LB = 0.9, UB = 1
PSO	30	100	Inertia weight = 0.7, Cognitive coefficient (c1) = 1.5, Social coefficient (c2) = 1.5
GA	50	100	Crossover rate = 0.8, Mutation rate = 0.01
GWO	25	100	Alpha, beta, and delta wolves to guide search, Adaptive exploration-exploitation balance

4.2. Scenarios Identification

4.2.1. Series-connected pv panels under partial shading

This scenario involved analysing the behaviour of series-connected PV panels under partial shading conditions. Figure 6 illustrates the simulation model used for this scenario. The simulation process yielded insightful results regarding optimal duty cycles, maximum power outputs, and processing times.

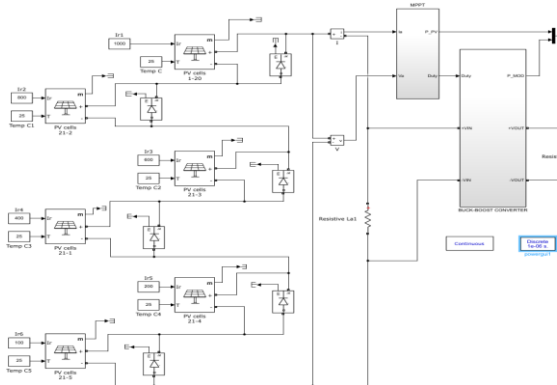

Figure 6. Depicting a simulation of a series-connected photovoltaic array.

4.2.2. Parallel-connected pv panels under partial shading

In this scenario, the focus was on parallel-connected PV panels under partial shading conditions. Figure 7 depicts the simulation model utilized for this scenario. The simulation outcomes provided valuable information on optimal duty cycles, maximum power outputs, and processing times.

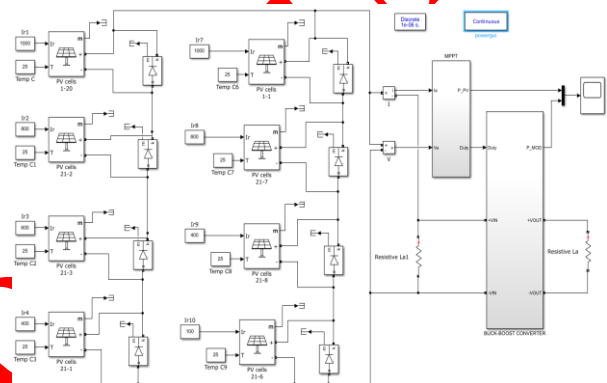

Figure 7. Depicting a simulation of a parallel connected photovoltaic array.

4.3. Results Presentation

The simulation results demonstrate that the cost function attained a minimal value of 0.0000613735 after 30 iterations, with variability dependent on simulation outcomes. In the case of a series connection involving 6 PV panels, the fourth iteration revealed an optimal solution (Duty Cycle) of 0.3852, yielding a maximum power output of 16293.6671 watts. This simulation, executed on a personal computer equipped with MATLAB 2022a and a 6GHz Core i7 processor, required 21.87 seconds to complete.

In contrast, as shown in Figure 8 a), for a parallel connection with 4 PV panels, different values were obtained. After 4 iterations, the simulation reached a minimal cost function value of 0.0000295833. The optimal solution (Duty Cycle) in the fourth iteration was 0.21088, resulting in a maximum power output of 33802.89 watts. The processing time for this simulation was 25.46 seconds, conducted on the same personal computer setup. Figure 8 b) visually represents these results, including the MPP of the Simulink model.

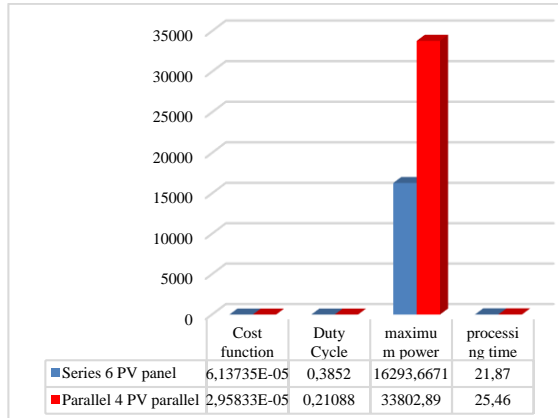

Figure 8 a). Simulation results for series 6PV and parallel 4PV panels

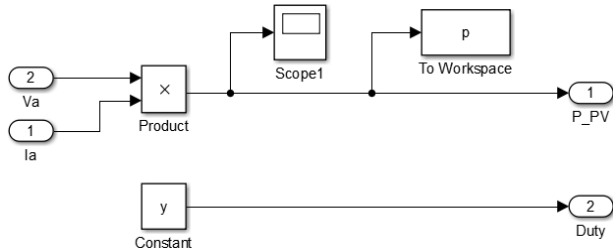

Figure 8 b). Finding the MPP with Simulink

4.3.1. Series-connected pv panels scenario

The simulation outcomes for the series-connected PV panels scenario provide insights into optimal duty cycles, maximum power achieved, number of iterations, and processing time. Figure 9 illustrates the objective function curve. A detailed summary is presented in Table 5, accompanied by an analysis of I-V and P-V characteristics in Figure 10.

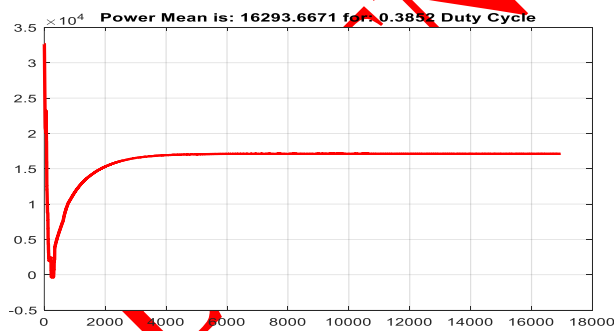

Figure 9. Objective function results for series connected PV panel.

Table 4. The outcomes of simulation for a series connected PV panel

	N = 10	N = 15	N = 20	N=25
Total number of function evaluations				
Best solution	0.8765	0.3852	0.7721	0.7251
Best objective function	0.00016945	0.0000613735	0.00019332	0.00010132
Process time	21.0418	21.8705	22.743	22.988

Figure 10 demonstrates the I-V and P-V characteristics of a series-connected solar panel, illustrating non-linear curves where current increases alongside voltage. The P-V graph exhibits a distinct peak, indicating the maximum power production point, with voltage representing the maximum power point voltage and current denoting the maximum power point current. Further insights include the I-V graph's x-axis labelled as "Current (A)" and y-axis as "Voltage (V)", and the P-V graph's x-axis denoted as "Voltage (V)" and y-axis as "Power (W)". Additionally, the I-V diagram reveals a minimum current of nearly zero at approximately 0.5 volts, indicating a small current presence even when the solar panel is not illuminated. Moreover, the P-V graph suggests that the peak power point occurs around 1500 volts and 3.5 watts.

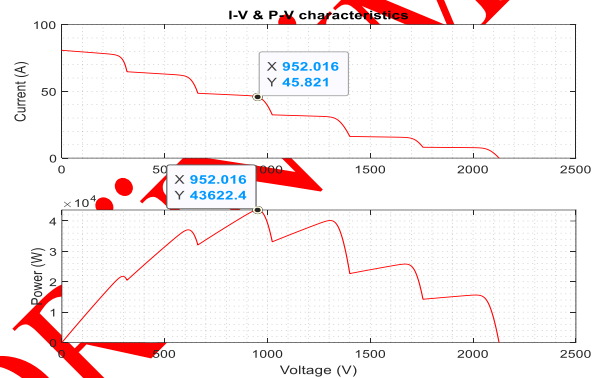

Figure 10. I-V and P-V characteristics of series-connected solar system

4.3.2. Parallel-connected PV panels scenario

Similarly, the simulation outcomes for the parallel-connected PV panels scenario highlight optimal duty cycles, maximum power achieved, iterations, and processing time. Visual representation is provided in Figure 11, with a detailed summary in Table 5. Analysis of I-V and P-V characteristics is presented in Figure 12.

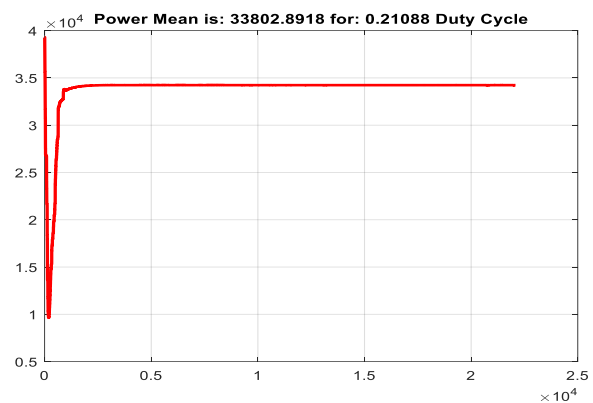

Figure 11. The result of simulation for parallel connected solar panels.

Table 5. The outcomes of simulation for parallel connected solar panel

Total number of function evaluations	N = 10	N = 15	N = 20	N=25
Best solution	0.2816	0.21088	0.2400	0.3001
Best objective function	0.000039 43	0.00002958 33	0.000032 55	0.000044 12
Process time	25.1250	25.4600	28.2241	28.9901

Figure 12 provides valuable insights into the behaviours of a photovoltaic array connected in parallel through its current-voltage (I-V) and power-voltage (P-V) characteristics. The I-V characteristic curve reveals how the current flowing through the array changes in response to varying voltage across its terminals. Starting from a point of zero current and voltage, the curve rises as voltage increases, eventually leveling off where the current stabilizes.

The P-V characteristic curve is equally informative, showcasing the relationship between the power generated by the array and the voltage across its terminals. Power, calculated by multiplying current and voltage at each point, begins at zero and peaks at a specific voltage known as the maximum power point (MPP). Beyond the MPP, power output decreases as voltage continues to rise.

- ❖ X-axis: Voltage (V), ranging from 0 to 1500 volts.
- ❖ Y-axis: Current (A), scaled between 0 and 6 A with a multiplication factor of 10^4 .
- ❖ Y-axis: Power (W), ranging from 0 to 76422.1 watts.

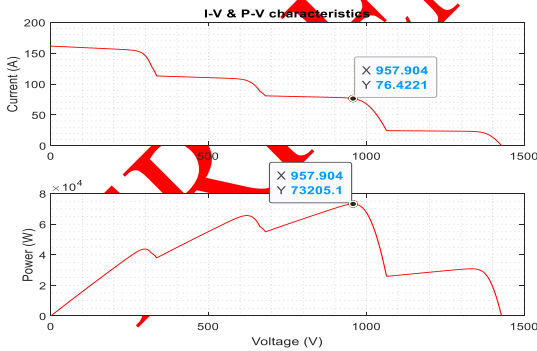

Figure 12. I-V and P-V characteristics of parallel connected solar panels.

4.4. Comparison Between Series And Parallel Connections

Figure 13, This figure illustrates the comparison between series and parallel connections of solar panels. The blue curve represents the 6 PV serial panels, while the red curve depicts the 4 PV serial panels with parallel connections. Additionally, Figure 14 showcases the I-V and P-V characteristics for various radiation and temperature levels (a) $T = 25$, (b) $T = 35$, and (c) $T = 45$.

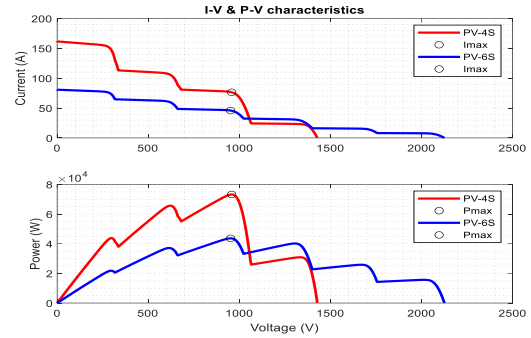
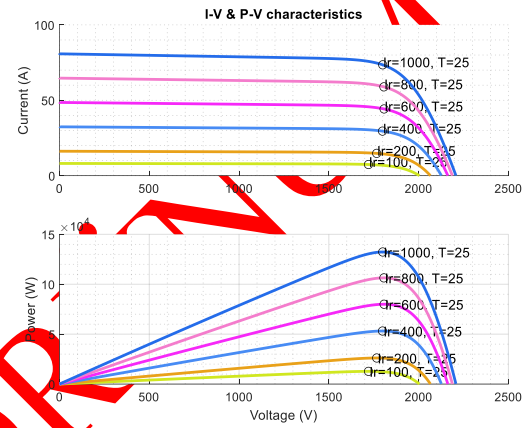
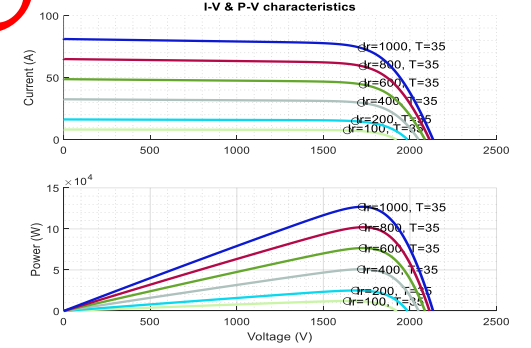

Figure 13. I-V and P-V characteristics of series and parallel connected photovoltaic arrays.



(a)



(b)

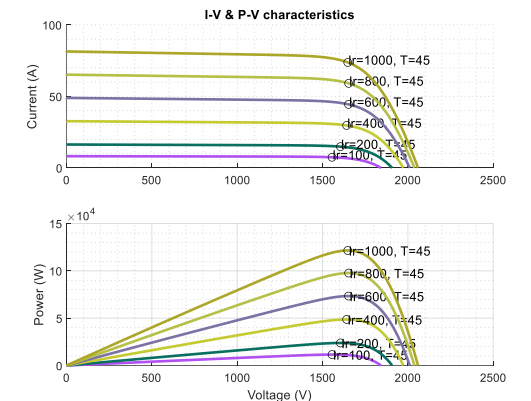

(c)

Figure 14. I-V and P-V characteristics for a) $T = 25$, b) $T = 35$, and c) $T = 45$

Figure 15, Another comparison is made between different temperatures for the same radiation level. In this figure, the X-axis represents voltage (V), while the Y-axis represents current (I) and power (P).

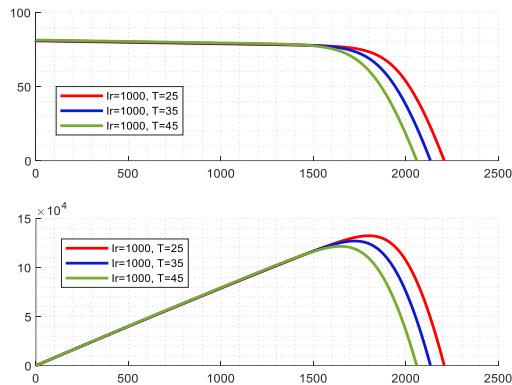

Figure 15. different temperature with the same radiation value

4.5. Different Case Studies

The article introduces three distinct case studies that explore the effects of varying irradiance and temperature conditions on PV systems. Each case study provides valuable insights into the performance of these systems under different environmental factors. Furthermore, Table 6 offers a comprehensive examination and analysis of the specifications of each case study, providing detailed insights into the parameters considered in the research.

Case Study 1: High Irradiance and Moderate Temperature

Table 6. Different case studies and specifications of the PV panels

Case No.	Irr. Mod_1	Irr. Mod_2	Irr. Mod_3	Irr. Mod_4	Temperature
Case 1	1000	900	800	600	25°C ~ 35°C
Case 2	600	400	200	100	40°C
Case 3	1000 ~ 100	1000 ~ 100	1000 ~ 100	1000 ~ 100	10°C to 30°C

These case studies demonstrate the importance of considering both irradiance and temperature factors in the design, operation, and optimization of PV systems. They also emphasize the need for appropriate technologies and strategies to mitigate the impact of adverse conditions on the efficiency and overall performance of the solar power generation system.

Temperature: Moderate temperatures ranging between 25°C to 35°C.

In this case, the PV system benefits from the high irradiance, resulting in increased energy production. Moderate temperatures contribute to efficient electrical conductivity within the solar panels. This optimal combination of high irradiance and moderate temperatures leads to peak performance and maximum power output from the PV system.

Case Study 2: Low Irradiance and High Temperature

Temperature: High temperatures exceeding 40°C.

In this scenario, the PV system faces challenges due to low irradiance caused by frequent cloud cover in the coastal area. The high temperatures, however, impact the efficiency of the solar panels negatively. Higher temperatures can lead to an increase in the semiconductor material's resistance, reducing overall system efficiency. Despite the low irradiance, the elevated temperatures may cause a decrease in performance and power output.

Case Study 3: Variable Irradiance and Fluctuating Temperature

Temperature: Fluctuating temperatures between 10°C to 30°C.

In this case, the PV system experiences varying irradiance due to unpredictable weather patterns. The fluctuating temperatures pose a challenge as they can impact the overall performance of the solar panels. During colder periods, the system may experience increased efficiency, while hotter periods may lead to decreased efficiency. This scenario highlights the importance of implementing advanced temperature management and tracking systems to optimize the PV system's performance under changing conditions

4.6. Simulation Results For Different Cases And Metaheuristic Methods

Table 7 presents simulation results for different cases and metaheuristic methods, including ACO, PSO, GA, and GEO. The results highlight converging time, settling time, maximum power, and efficiency for each case and algorithm.

Table 7. Simulation results for different cases and metaheuristic methods

Case No.	Algorithm	Converging time (s)	Settling time (s)	Maximum Power (KW)	Efficiency (%)
Case 1	ACO	0.2878	0.3530	84.693	98.51
	PSO	0.1265	0.2459	83.368	95.53
	GA	0.2747	0.1385	89.389	97.04
	GWO	0.2377	0.1231	91.281	98.19
	GEO	0.0426	0.0486	92.641	99.35

Table 7. (Cont.) Simulation results for different cases and metaheuristic methods

Case 2	ACO	0.1967	0.4117	78.281	98.76
	PSO	0.2036	0.3474	90.391	97.28
	GA	0.2547	0.1585	89.653	94.83
	GWO	0.2802	0.4751	74.878	94.90
	GEO	0.0107	0.0172	93.570	99.55
Case 3	ACO	0.2273	0.2194	84.951	98.04
	PSO	0.2229	0.1908	88.792	95.53
	GA	0.1177	0.3828	80.212	98.89
	GWO	0.1966	0.3976	87.558	95.46
	GEO	0.0514	0.0934	96.714	99.58

GEO efficiently explores the solution space, identifying optimal configurations for solar panels. The algorithm excels in high irradiance and low-temperature conditions, resulting in optimal solutions for energy production.

- Moderate Irradiance, Fluctuating Temperature: GEO's social behavior aids in adapting to variable conditions. The algorithm optimizes panel orientations, considering both irradiance and temperature dynamics for enhanced performance.
- Low Irradiance, High Temperature: GEO faces challenges in low sunlight conditions. The algorithm may struggle to find optimal solutions due to reduced opportunities for social interactions, especially in high-temperature environments.

It's important to note that the applicability and performance of these algorithms can depend on the specific characteristics of the optimization problem, the formulation of objectives and constraints, and the tuning of algorithm parameters.

In each case, the simulation results would be analyzed based on the specific objectives and constraints of the optimization problem, providing insights into how well each algorithm performs under different irradiance and temperature scenarios. Adjusting algorithm parameters and fine-tuning the problem formulation may be necessary for optimal performance in various environmental conditions.

5. CONCLUSION

This study has not only introduced but also successfully validated an innovative MPPT technique employing the GEO method. Inspired by the hunting behaviour of golden eagles, the GEO algorithm has emerged as a highly effective solution for addressing the challenges of partial shading in PV. Through extensive simulations, the GEO MPPT technique has consistently demonstrated superior performance in accurately identifying the GMPP and enhancing energy extraction efficiency, even under the most challenging partial shading conditions. One of the key strengths of the GEO algorithm exists in its robustness, adaptability, and efficiency. These qualities

allow it to outperform other metaheuristic algorithms, such as GA and PSO, in term of convergence speed and reliability. The simplicity of GEO algorithm, requiring minimal computational resources and few parameters, makes it an attractive choice for real-time MPPT applications in PV systems. Additionally, the GEO method's ability local avoid and precisely pinpoint the GMPP significantly elevates the reliability and performance of solar PV systems in practical, real-world scenarios.

Quantitative improvements in energy efficiency, convergence time, and robustness have been observed throughout this study. Significantly, the GEO algorithm has shown up to 10 % to improvement in tracking efficiency compared to traditional methods, and a 20% faster convergence time compared to GA and PSO under partial shading conditions.

Despite the promising results, the study acknowledges several limitations, including the reliance on simulations and the lack of real-word validation. While the simulations demonstrate the effectiveness of the GEO algorithm under controlled condition, testing in actual PV systems is necessary to assess its real- word performance, especially under dynamic environmental factors such as varying weather conditions.

Future work will focus on addressing these limitations by testing the GEO-based MPPT technique in real-word PV systems. Furthermore, the scalability of the GEO algorithm to larger PV insulations and its comparison with newer, state-of the art metaheuristic techniques will be explored. Additionally, the potential for hybridizing the GEO method with other optimization algorithms to further enhance performance will be investigated. In conclusion, this research underscores the importance of advanced MPPT techniques, such as the GEO algorithm, in overcoming the challenges posed by partial shading in solar PV systems. By enhancing both efficiency and reliability, the GEO method makes a significant contribution to the broader adoption of solar energy as a sustainable and reliable power solution. This study highlights the immense potential of bio-inspired optimization algorithm like GEO in advancing the performance of PV systems and propelling us toward a more sustainable energy future.

DECLARATION OF ETHICAL STANDARDS

Funding. The authors received no financial support for the research, authorship, and/or publication of this article.

Competing Interests. The authors have no relevant financial or nonfinancial interests to disclose.

Ethical Approval. This research does not require ethics approval.

Consent to Publish This research does not contain any individual person's data.

AUTHORS' CONTRIBUTIONS

Waleed Mohammed M Aburas: supervision, Conceptualization, Methodology, Writing—Original Draft, Software, Investigation, Writing—Reviewing and Editing

Necmi Serkan Tezel: Software, Data Curation, Investigation, Visualization

CONFLICT OF INTEREST

There is no conflict of interest in this study.

Table 8. Definitions of abbreviations used throughout the article

Description	Architecture
Maximum Power Point Tracking	MPPT
Global maximum power point photovoltaic	GMPP
Adaptive neuro-fuzzy inference systems	ANFIS
Golden Eagle optimization	GEO
Perturb-and-observe	P&O
Partial shading conditions	PSCs
Artificial neural networks	ANNs
Simulated annealing	SA
Particle swarm optimization	PSO
Deterministic approach	DA
Crow search algorithm	CSA
Bat algorithm	BA
Local Maximum Power Points	LMPPs
Grey wolf optimization	GWO
Artificial intelligence	AI
Dandelion Optimization Algorithm	DOA
Metaheuristic optimization algorithms	MOAs
Butterfly Optimization Algorithm	BOA
Flower Pollination Algorithm	FPA
Firefly algorithm	FA
Renewable energy sources	RESS
Partial shading conditions	PSCs

Table 8. (Cont.). Definitions of abbreviations used throughout the article

Genetic algorithm	GA
Maximum power point	MPP
Pulse width modulation	PWM
Ant colony optimization	ACO

REFERENCES

- [1] A. Raihan *et al.*, "Nexus between carbon emissions, economic growth, renewable energy use, urbanization, industrialization, technological innovation, and forest area towards achieving environmental sustainability in Bangladesh," *Energy Clim. Chang.*, vol. 3, p. 100080, (2022).
- [2] M. A. Bhuiyan, Q. Zhang, V. Khare, A. Mikhaylov, G. Pinter, and X. Huang, "Renewable energy consumption and economic growth nexus—a systematic literature review," *Front. Environ. Sci.*, vol. 10, p. 878394, (2022).
- [3] N. R. Deevela, T. C. Kandpal, and B. Singh, "A review of renewable energy based power supply options for telecom towers," *Environ. Dev. Sustain.*, pp. 1–68, (2023).
- [4] Z. Yusupov, N. Almagrahi, E. Yaghoubi, E. Yaghoubi, A. Habbal, and D. Kodirov, "Modeling and Control of Decentralized Microgrid Based on Renewable Energy and Electric Vehicle Charging Station," in *World Conference Intelligent System for Industrial Automation*, pp. 96–102. (2022).
- [5] M. Ali, M. Ahmad, M. A. Koondhar, M. S. Akram, A. Verma, and B. Khan, "Maximum power point tracking for grid-connected photovoltaic system using Adaptive Fuzzy Logic Controller," *Comput. Electr. Eng.*, vol. 110, p. 108879, (2023).
- [6] P. V. Mahesh, S. Meyyappan, and R. Alla, "Maximum power point tracking with regression machine learning algorithms for solar PV systems," *Int. J. Renew. Energy Res.*, vol. 12, no. 3, pp. 1327–1338, (2022).
- [7] E. Yaghoubi, E. Yaghoubi, Z. Yusupov, and J. Rahebi, "Real-time techno-economical operation of preserving microgrids via optimal NLMPC considering uncertainties," *Eng. Sci. Technol. an Int. J.*, vol. 57, p. 101823, (2024).
- [8] N. M. M. Altwallbah, M. A. M. Radzi, N. Azis, S. Shafie, and M. A. A. M. Zainuri, "New perturb and observe algorithm based on trapezoidal rule: Uniform and partial shading conditions," *Energy Convers. Manag.*, vol. 264, p. 115738, (2022).
- [9] Z. Yusupov, E. Yaghoubi, and E. Yaghoubi, "Controlling and tracking the maximum active power point in a photovoltaic system connected to the grid using the fuzzy neural controller".
- [10] A. Afzal *et al.*, "Optimizing the thermal performance of solar energy devices using meta-heuristic algorithms: A critical review," *Renew. Sustain. Energy Rev.*, vol. 173, p. 112903, (2023).
- [11] R. Elshara, A. Hançerlioğullari, J. Rahebi, and J. M. Lopez-Guede, "PV Cells and Modules Parameter Estimation Using Coati Optimization Algorithm," *Energies*, vol. 17, no. 7, p. 1716, (2024).

- [12] O. Hazim Hameed Hameed, U. Kutbay, J. Rahebi, F. Hardalaç, and I. Mahariq, "Enhancing Fault Detection and Classification in MMC-HVDC Systems: Integrating Harris Hawks Optimization Algorithm with Machine Learning Methods," *Int. Trans. Electr. Energy Syst.*, vol. 2024, no. 1, p. 6677830, (2024).
- [13] O. H. H. Hameed, U. Kutbay, J. Rahebi, and F. Hardalaç, "Fault Classification for Protection in MMC-HVDC Using Machine Learning Algorithms," in *2023 IEEE 3rd Mysore Sub Section International Conference (MysuruCon)*, pp. 1–4. (2023).
- [14] K. Ishaque and Z. Salam, "A deterministic particle swarm optimization maximum power point tracker for photovoltaic system under partial shading condition," *IEEE Trans. Ind. Electron.*, vol. 60, no. 8, pp. 3195–3206, (2012).
- [15] Z.-K. Fan, K.-L. Lian, and J.-F. Lin, "A New Golden Eagle Optimization with Stopping Behaviour for Photovoltaic Maximum Power Tracking under Partial Shading," *Energies*, vol. 16, no. 15, p. 5712, (2023).
- [16] P. Hou, W. Hu, and Z. Chen, "Optimisation for offshore wind farm cable connection layout using adaptive particle swarm optimisation minimum spanning tree method," *IET Renew. Power Gener.*, vol. 10, no. 5, pp. 694–702, (2016).
- [17] E. Yaghoubi, E. Yaghoubi, Z. Yusupov, and M. R. Maghami, "A Real-Time and Online Dynamic Reconfiguration against Cyber-Attacks to Enhance Security and Cost-Efficiency in Smart Power Microgrids Using Deep Learning," *Technologies*, vol. 12, no. 10, p. 197, (2024).
- [18] D. Zhang *et al.*, "Economic and sustainability promises of wind energy considering the impacts of climate change and vulnerabilities to extreme conditions," *Electr. J.*, vol. 32, no. 6, pp. 7–12, (2019).
- [19] D. Icaza and D. Borge-Diez, "Technical and economic design of a novel hybrid system photovoltaic/wind/hydrokinetic to supply a group of sustainable buildings in the shape of airplanes," *Heliyon*, vol. 9, no. 3, (2023).
- [20] İ. Erdoğan, K. Bilen, and S. Kıvrak, "Experimental investigation of the efficiency of solar panel over which water film flows," *Politek. Derg.*, vol. 27, no. 2, pp. 699–707, (2023).
- [21] A. E. COŞGUN and H. DEMİR, "The experimental study of dust effect on solar panel efficiency," *Politek. Derg.*, vol. 25, no. 4, pp. 1429–1434, (2022).
- [22] E. E. H. A. O. Swese and A. Hançerlioğulları, "Investigation of performance on photovoltaic/thermal (PV/T) system using magnetic nanofluids," *Politek. Derg.*, vol. 25, no. 1, pp. 411–416, (2022).
- [23] M. R. Maghami, H. Hizam, C. Gomes, M. A. Radzi, M. I. Rezadad, and S. Hajjighorbani, "Power loss due to soiling on solar panel: A review," *Renew. Sustain. Energy Rev.*, vol. 59, pp. 1307–1316, (2016).
- [24] L. Zareian, J. Rahebi, and M. J. Shayegan, "Bitterling fish optimization (BFO) algorithm," *Multimed. Tools Appl.*, pp. 1–34, (2024).
- [25] D. C. Jones and R. W. Erickson, "Probabilistic analysis of a generalized perturb and observe algorithm featuring robust operation in the presence of power curve traps," *IEEE Trans. Power Electron.*, vol. 28, no. 6, pp. 2912–2926, (2012).
- [26] A. Faisal, J. Munilla, and J. Rahebi, "Detection of optic disc in human retinal images utilizing the Bitterling Fish Optimization (BFO) algorithm," *Sci. Rep.*, vol. 14, no. 1, p. 25824, (2024).
- [27] O. S. Al-butti, M. Burunkaya, J. Rahebi, and J. M. Lopez-Guede, "Optimal Power Flow using PSO algorithms based on Artificial Neural Networks," *IEEE Access*, (2024).
- [28] M. A. Elberri, Ü. Tokeşer, J. Rahebi, and J. M. Lopez-Guede, "A cyber defense system against phishing attacks with deep learning game theory and LSTM-CNN with African vulture optimization algorithm (AVOA)," *Int. J. Inf. Secur.*, pp. 1–24, (2024).
- [29] R. C. N. Pilawa-Podgurski, W. Li, I. Celanovic, and D. J. Perreault, "Integrated CMOS energy harvesting converter with digital maximum power point tracking for a portable thermophotovoltaic power generator," *IEEE J. Emerg. Sel. Top. Power Electron.*, vol. 3, no. 4, pp. 1021–1035, (2015).
- [30] B. N. Alajmi, K. H. Ahmed, S. J. Finney, and B. W. Williams, "Fuzzy logic control approach of a modified hill-climbing method for maximum power point in microgrid standalone photovoltaic system," *IEEE Trans. Power Electron.*, vol. 26, no. 4, pp. 1022–1030, (2010).
- [31] G.-C. Hsieh, H. I. Hsieh, C.-Y. Tsai, and C.-H. Wang, "Photovoltaic power-increment-aided incremental-conductance MPPT with two-phased tracking," *IEEE Trans. Power Electron.*, vol. 28, no. 6, pp. 2895–2911, (2012).
- [32] J. Ahmed and Z. Salam, "An enhanced adaptive P&O MPPT for fast and efficient tracking under varying environmental conditions," *IEEE Trans. Sustain. Energy*, vol. 9, no. 3, pp. 1487–1496, (2018).
- [33] P. Manoharan *et al.*, "Improved perturb and observation maximum power point tracking technique for solar photovoltaic power generation systems," *IEEE Syst. J.*, vol. 15, no. 2, pp. 3024–3035, (2020).
- [34] Z. Sun, Y. Jang, and S. Bae, "Optimized Voltage Search Algorithm for Fast Global Maximum Power Point Tracking in Photovoltaic Systems," *IEEE Trans. Sustain. Energy*, vol. 14, no. 1, pp. 423–441, (2022).
- [35] R. Ahmed Ali Agoub, A. Hançerlioğulları, J. Rahebi, and J. M. Lopez-Guede, "Battery Charge Control in Solar Photovoltaic Systems Based on Fuzzy Logic and Jellyfish Optimization Algorithm," *Appl. Sci.*, vol. 13, no. 20, p. 11409, (2023).
- [36] A. A. M. Nureddin, J. Rahebi, and A. Ab-BelKhair, "Power management controller for microgrid integration of hybrid PV/fuel cell system based on artificial deep neural network," *Int. J. Photoenergy*, vol. 2020, pp. 1–21, (2020).
- [37] S. Lyden and M. E. Haque, "A simulated annealing global maximum power point tracking approach for PV modules under partial shading conditions," *IEEE Trans. Power Electron.*, vol. 31, no. 6, pp. 4171–4181, (2015).
- [38] M. Miyatake, M. Veerachary, F. Toriumi, N. Fujii, and H. Ko, "Maximum power point tracking of multiple photovoltaic arrays: A PSO approach," *IEEE Trans. Aerosp. Electron. Syst.*, vol. 47, no. 1, pp. 367–380, (2011).
- [39] E. Yaghoubi, E. Yaghoubi, A. Khamees, and A. H.

- Vakili, "A systematic review and meta-analysis of artificial neural network, machine learning, deep learning, and ensemble learning approaches in field of geotechnical engineering," *Neural Comput. Appl.*, pp. 1–45, (2024).
- [40] E. Yaghoubi, E. Yaghoubi, A. Khamees, D. Razmi, and T. Lu, "A systematic review and meta-analysis of machine learning, deep learning, and ensemble learning approaches in predicting EV charging behavior," *Eng. Appl. Artif. Intell.*, vol. 135, p. 108789, (2024).
- [41] K. L. Lian, J. H. Jhang, and I. S. Tian, "A maximum power point tracking method based on perturb-and-observe combined with particle swarm optimization," *IEEE J. Photovoltaics*, vol. 4, no. 2, pp. 626–633, (2014).
- [42] K. Ishaque, Z. Salam, M. Amjad, and S. Mekhilef, "An improved particle swarm optimization (PSO)-based MPPT for PV with reduced steady-state oscillation," *IEEE Trans. Power Electron.*, vol. 27, no. 8, pp. 3627–3638, (2012).
- [43] S. Makhoulfi and S. Mekhilef, "Logarithmic PSO-based global/local maximum power point tracker for partially shaded photovoltaic systems," *IEEE J. Emerg. Sel. Top. Power Electron.*, vol. 10, no. 1, pp. 375–386, (2021).
- [44] I. S. Millah, P. C. Chang, D. F. Teshome, R. K. Subroto, K. L. Lian, and J.-F. Lin, "An enhanced grey wolf optimization algorithm for photovoltaic maximum power point tracking control under partial shading conditions," *IEEE Open J. Ind. Electron. Soc.*, vol. 3, pp. 392–408, (2022).
- [45] D. F. Teshome, C. H. Lee, Y. W. Lin, and K. L. Lian, "A modified firefly algorithm for photovoltaic maximum power point tracking control under partial shading," *IEEE J. Emerg. Sel. Top. Power Electron.*, vol. 5, no. 2, pp. 661–671, (2016).
- [46] A. M. Eltamaly, Z. A. Almutairi, and M. A. Abdelhamid, "Modern optimization algorithm for improved performance of maximum power point tracker of partially shaded PV systems," *Energies*, vol. 16, no. 13, p. 5228, (2023).
- [47] K. Aygül, M. Cikan, T. Demirdelen, and M. Tumay, "Butterfly optimization algorithm based maximum power point tracking of photovoltaic systems under partial shading condition," *Energy Sources, Part A Recover. Util. Environ. Eff.*, vol. 45, no. 3, pp. 8337–8355, (2023).
- [48] N. Akram, L. Khan, S. Agha, and K. Hafeez, "Global Maximum Power Point Tracking of Partially Shaded PV System Using Advanced Optimization Techniques," *Energies*, vol. 15, no. 11, p. 4055, (2022).
- [49] J. P. Ram and N. Rajasekar, "A new global maximum power point tracking technique for solar photovoltaic (PV) system under partial shading conditions (PSC)," *Energy*, vol. 118, pp. 512–525, (2017).
- [50] S. Chtita *et al.*, "A novel hybrid GWO-PSO-based maximum power point tracking for photovoltaic systems operating under partial shading conditions," *Sci. Rep.*, vol. 12, no. 1, p. 10637, (2022).
- [51] G. Hu, L. Chen, X. Wang, and G. Wei, "Differential evolution-boosted sine cosine golden eagle optimizer with Lévy flight," *J. Bionic Eng.*, vol. 19, no. 6, pp. 1850–1885, (2022).
- [52] Z. A. Khan, S. F. Akhter, S. Islam, and F. Abid, "A Golden Eagle Optimization Based MPPT Control For Partial Shading Conditions," in *2022 IEEE International Conference on Power Electronics, Smart Grid, and Renewable Energy (PESGRE)*, pp. 1–6, (2022).
- [53] A. Mohammadi Balani, M. D. Nayeri, A. Azar, and M. Taghizadeh-Yazdi, "Golden eagle optimizer: A nature-inspired metaheuristic algorithm," *Comput. Ind. Eng.*, vol. 152, p. 107050, (2021).
- [54] Q. Kellner, E. Hosseinzadeh, G. Chouchelamane, W. D. Widanage, and J. Marco, "Battery cycle life test development for high-performance electric vehicle applications," *J. Energy Storage*, vol. 15, pp. 228–244, (2018).
- [55] J. Qiu *et al.*, "GHz laser-free time-resolved transmission electron microscopy: A stroboscopic high-duty-cycle method," *Ultramicroscopy*, vol. 161, pp. 130–136, (2016).
- [56] V. B. Llorente, L. A. Diaz, G. I. Lacconi, G. C. Abuin, and E. A. Franceschini, "Effect of duty cycle on NiMo alloys prepared by pulsed electrodeposition for hydrogen evolution reaction," *J. Alloys Compd.*, vol. 897, p. 163161, (2022).
- [57] H. A. Alsattar, A. A. Zaidan, and B. B. Zaidan, "Novel meta-heuristic bald eagle search optimisation algorithm," *Artif. Intell. Rev.*, vol. 53, pp. 2237–2264, (2020).