



## Design and Fabrication of Multi-Magnetron Microwave Oven for High-Temperature Applications

Ahmet Özmen <sup>1</sup>, Aykut Coşkun <sup>2</sup>, Mehmet Ertuğrul <sup>3</sup>

<sup>1</sup>Agri Ibrahim Cecen University, Department of Electronics and Automation, Agri, ahmet25440@gmail.com

<sup>2</sup>Bayburt University, Department of Electrical and Electronics Engineering, Bayburt, aykut25coskun@gmail.com

<sup>3</sup>Karadeniz Technical University, Metallurgy and Materials Engineering, Trabzon, ertugrul@ktu.edu.tr

Cite this study:

Özmen, A., Coşkun, A., & Ertugrul, M. (2025). Design and Fabrication of Multi-Magnetron Microwave Oven for High-Temperature Applications. Turkish Journal of Engineering. 9 (1), 95-102

<https://doi.org/10.31127/tuje.1520661>

### Keywords

Multi-Magnetron  
High-Temperature Oven  
Power Density  
Microwave Oven

### Abstract

This article examines the design, manufacture, and performance of multi-magnetron ovens capable of reaching high temperatures. Firstly, an appropriate waveguide was simulated, and the production process was completed. Then, the proposed designs for multi-magnetron ovens were simulated, and appropriate dimensions were suggested. It was reported that the average power density (PD) value of the produced multi-magnetron oven was 0.37 mW/cm<sup>2</sup>, which indicates its performance and efficiency. This value was found to be compliant with standards and safe for human use. The main objective of our study was to demonstrate that waveguides can reach high temperatures at the center of the oven without affecting each other. In this context, it was observed that the temperature created by magnetrons operating in single, double, triple, and quadruple modes gradually increased at the center of the oven. The simulation results supporting this showed that the S<sub>21</sub> parameter was -177 dB. The design proposed and applied in our study was efficient, easy to produce, safe for human use, low cost, and usable in commercial and academic studies for reaching high temperatures. Overall, the multi-magnetron oven design proved to be a successful and practical solution for applications requiring high temperatures, showcasing its potential for both industrial and research purposes. The findings of this study contribute valuable insights into the development of advanced heating technologies, demonstrating significant improvements in efficiency and safety for high-temperature applications.

### Research Article

Received:22.07.2024

Revised:25.08.2024

Accepted:28.08.2024

Published:20.01.2025



## 1. Introduction

Microwave ovens have become increasingly prevalent in various fields such as household, industry, agriculture, and academia. In industrial settings, where glass, metal, and ceramics require high temperatures for processing, microwave ovens have been extensively adopted due to their ability to reach high temperatures. Likewise, in agriculture, microwave ovens are utilized in drying systems [1–3] to reduce drying time and energy consumption [4]. The unique features of microwave ovens, such as the ability to shorten chemical reaction times, increase efficiency, and enhance product purity, have made them a popular choice in a wide range of applications. As a result, researchers in organic chemistry [5], polymer chemistry, biochemistry, materials science, and nanotechnology have shown

increasing interest in this technology. To meet these growing demands, the development of microwave ovens has been accelerated [6].

Upon reviewing the literature, it is evident that microwave ovens have emerged as a new and innovative approach for Carbon Nanotube (CNT) synthesis, which is the subject of numerous studies in addition to the aforementioned fields of application [7–12]. Moreover, the utilization of microwave ovens in graphene synthesis, another crucial area of research, has been documented [13–15]. Likewise, microwave ovens have found applications in Yttrium barium copper oxide (YBCO), nanostructures, and organic synthesis [16–21]. Notably, microwave technology for plastic waste recycling is another significant application that has garnered attention [22]. However, the disadvantage of household ovens used in such studies is their limited temperature

range. Consequently, there is a growing interest in ovens that can attain high temperatures to address this limitation.

Various heating technologies have been developed for high-temperature material processing, which can be classified into contact and non-contact methods. The contact method employs heat transfer to materials, hot air convection, or infrared irradiation to cause direct heating of materials. Conversely, the non-contact method employs microwave or radio frequency (RF) waves as a heat source. These waves convert into thermal energy within the materials and heat the material through interactions between the material and the electromagnetic field [23].

In the non-contact method, the microwave wave can reflect, absorb, or do both in certain amounts, depending on the material's properties. Materials with high insulating properties transmit microwaves without absorption and hence do not heat up. In contrast, microwaves reflected from the surface of conductive materials do not heat the material. However, microwaves absorbed in materials with dielectric properties heat the material effectively. Therefore, materials with dielectric properties are more suitable for heating in microwave ovens.

The heating mechanics of microwave ovens differ from conventional heating systems. In conventional heating, heating occurs from the surface to the inside, which results in slow and non-uniform heating. In contrast, microwave ovens employ direct energy transfer, leading to molecular or even nanoscale heating [24].

Microwave ovens utilize magnetrons as microwave generators which emit electromagnetic waves with a frequency of 2.45 GHz. Based on the number of these magnetrons, microwave ovens can be categorized into single-magnetron and multi-magnetron ovens. Single magnetron ovens are typically used for low-temperature applications, while multi-magnetron ovens are preferred for medium and high temperatures. Recent studies have shown that multi-magnetron ovens are designed to reach high temperatures [23, 25–34]. However, in multi-magnetron ovens, the magnetrons must focus on heating the material inside the oven to avoid the damping of EM waves by hitting the oven surfaces and other parts. To achieve this, some designs have been proposed in the literature, such as a two-input multi-magnetron oven design which has been shown to achieve efficient microwave heating with a minimum port-to-port interaction of -52 dB [29]. Another design used a multi-magnetron oven to heat a SiC crucible up to 1000°C in just a few minutes for material processing [23]. These designs have shown that the proper design of multi-magnetron ovens can enable the attainment of very high temperatures, making them advantageous for industrial applications.

It is important to note that ensuring safety in using microwave ovens is crucial. As microwave ovens generate EM waves that can harm health, it is essential to minimize the leakage of microwaves outside the oven cavity. International standards have been set for microwave ovens to ensure their safe use. The specific absorption rate (SAR) value is used to measure the

amount of EM energy absorbed by the body. According to international standards, the SAR value of microwave ovens should not exceed the limit of 5 W/kg. It is also important to measure and minimize the PD value and power amount per unit area to ensure safe use.

In conclusion, microwave ovens have become widespread in various fields due to their advantages, such as fast and efficient heating, shortening the duration of chemical reactions, and increasing the purity of the product. In particular, the use of multi-magnetron ovens has become more popular in recent years as they can reach high temperatures in a short time. However, ensuring the safety of microwave ovens is crucial, and measures should be taken to minimize microwave leaks and comply with international standards.

The overall aim of this study is to produce a microwave oven that can withstand high temperatures. To achieve this goal, the suitability of a multi-magnetron (4 magnetrons) oven for high temperatures was investigated. Suitable waveguides were proposed for the installation of the magnetrons in the oven. These waveguides were designed and introduced into the literature to transmit the electromagnetic waves from the magnetrons to the oven without reflection while minimizing the effect of other magnetrons installed in the oven. In addition, the effect of the positions of the waveguides relative to each other was investigated. Precautions were taken to ensure that the PD value of the produced oven met the standards, and the PD value in the environment was measured throughout the process. A programmable power circuit was prepared for the four magnetrons installed in the oven. The power circuit reached the desired temperature and time. Errors that may occur during temperature measurement were prevented during this process. As a result, new approaches were proposed for multi-magnetron systems that are difficult to control and measure temperature.

## 2. Method

The properties of both the material and the EM wave influence the heating of a material with microwaves. These properties include permittivity, conductivity, permeability, dipole moment, mass, boundary conditions, and intermolecular forces. Additionally, parameters such as the electric and magnetic fields and the frequency of the EM wave also play a role in heating. There are three primary methods for heating a material with microwaves: magnetic loss heating, conduction loss heating, and dielectric heating.

$$P_t = \frac{1}{2}\sigma|E|^2 + \pi f \epsilon_0 \epsilon_r''|E|^2 + \pi f \mu_0 \mu_r''|H|^2 \quad (1)$$

The thermal energy produced by the EM source per unit volume is given by Equation (1) [35], where  $|E|$  and  $|H|$  represent the electric and magnetic field strengths of the microwave,  $\sigma$  is the electrical conductivity,  $\epsilon_0$  and  $\mu_0$  are the dielectric constant of vacuum and magnetic permeability of vacuum, respectively,  $\epsilon_r''$  and  $\mu_r''$  are the relative dielectric and magnetic loss, respectively, and  $f$  is the frequency. Equation (1) represents the sum of the three types of heating, namely conduction loss, dielectric heating, and magnetic loss heating.

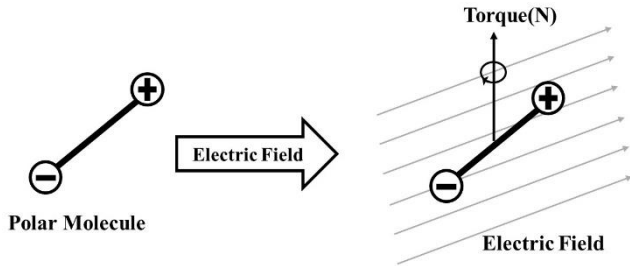

**Figure 1.** Dipole rotation of the polar molecule in the electric field.

In microwave ovens, two important heating mechanisms occur due to the dipolar and ionic properties of the materials: dipolar polarization and ionic conduction. Dipolar polarization involves the interaction between the electric field component of the magnetic field and the material, leading to the heating of materials with dipole moment when exposed to microwave radiation. As shown in Figure 1, dipoles exposed to the electric field experience a torque (N) and attempt to align with the electric field, resulting in a change in the direction of the dipoles as the electric field direction changes. This mobility causes the dipoles to collide and rub against each other, generating heat in the material. The applied frequency ability to direct the dipole is one of the effective factors in this warming. The heating is minimal at low frequencies since the dipoles rotate slowly, while at high frequencies, the dipoles cannot respond to the rapid electric field changes and do not rotate, leading to no heating. Good heating occurs at frequencies between these two limits. Microwave devices commonly use a 2.45 GHz frequency is suitable for achieving good heating. On the other hand, the heating of solids with a magnetic dipole moment occurs due to the magnetic field component of microwaves [36].

Conduction losses in solids are typically low at room temperature but can increase significantly with temperature. For instance, alumina ( $\text{Al}_2\text{O}_3$ ) can reach its melting point in a microwave oven within minutes, even though its dielectric loss is negligible ( $10^{-3}$ ) at ambient temperature. Defects in materials can often increase the conduction losses in solids. Another heating mechanism, ionic conduction, involves the movement of ions in a solution environment that collides with other atoms and molecules, resulting in heating from microwave radiation [24].

To better understand the heating mechanisms of materials, it is necessary to consider the loss tangent ( $\tan \delta = \frac{\epsilon''}{\epsilon'}$  value. This value takes into account the relative dielectric constant ( $\epsilon'$ ) and the dielectric loss factor ( $\epsilon''$ ), which represent the efficiency of electromagnetic radiation conversion into heat [37]. These two properties ( $\epsilon'$  and  $\epsilon''$ ) together determine the dielectric capability of the material, and the loss tangent provides information on how much of the electric field is converted into heat in the material.

## 2.1. Waveguide Design

Rectangular waveguides are commonly used in microwave oven designs because they can emit both TM and TE modes. However, for efficient power transmission, the waveguide should be designed to operate at the frequency of interest, with the dominant mode being TE<sub>10</sub>. The cut-off frequency, which is the lowest frequency at which a mode can propagate in the waveguide, is calculated using the formula:

$$f_{c,mn} = \frac{1}{2\pi\sqrt{\mu\epsilon}} \sqrt{\left(\frac{m\pi}{a}\right)^2 + \left(\frac{n\pi}{b}\right)^2} \quad (2)$$

where  $c$  is the speed of light and  $m$  and  $n$  are integers representing the possible modes of the EM wave. The TM<sub>11</sub> and TE<sub>10</sub> modes have the lowest cut-off frequency in rectangular waveguides.

For the waveguide to be used in a microwave oven, the operating frequency should be  $1.25 f_c < f < 1.89 f_c$ , and the cut-off frequency should be higher than the operating frequency to act as a high-pass filter. To ensure the dominant mode is TE<sub>10</sub>, the aspect ratio  $a:b$  of the rectangular waveguide should be such that  $a > b$ .

Finally, S parameters can be obtained by simulating the waveguide design in software such as CST. By drawing the waveguide with the appropriate dimensions (75-105 mm and  $b=2a$ ), the simulation can provide data on how the waveguide will behave in terms of transmission, reflection, and attenuation.

## 2.2. Oven Design and Manufacturing

The oven design (with dimensions of 28x28x28 cm) was based on the positioning and assembly of the waveguides, and two main designs were emphasized. In the first design, the waveguides were placed opposite each other at the same angle, as shown in Figure 2a. In the second design, the waveguides were placed opposite each other, with one waveguide rotated 90 degrees, as shown in Figure 2b. Both designs were simulated using the CST program, and reflection and transmission parameters were analyzed. Stainless steel was used on the outer surface of the oven for heat resistance, while the waveguides were made of aluminum. The oven design shown in Figure 2c was then manufactured as shown in Figure 2d.

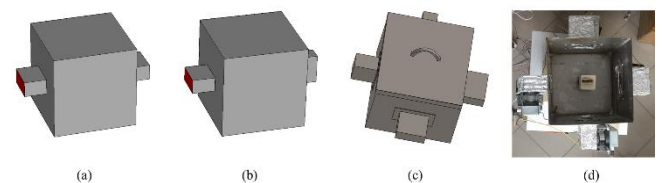

**Figure 2.** (a) Design-1 placed opposite the waveguides, (b) design-2 rotated 90 degrees, (c) SolidWorks design, (d) manufacture of the microwave oven.

## 2.3. Power Control of Microwave Oven

Commercial microwave ovens typically use magnetrons that operate at 4kV. The power circuit of these ovens typically includes a single high-voltage transformer, which has two secondary outputs classified as class 220. The voltage at the end of the transformer that is connected to the magnetron filament, which has a

primary voltage of about 220V, is referred to as the filament voltage and is approximately 3.3V. The other secondary output has a voltage of around 2100V.

There is a Villard voltage doubler circuit at the output of the transformer. This is the basic voltage doubler circuit and consists of a capacitor and diode. The diode works as a half-wave rectifier and charges the capacitor in positive polarity. On the other hand, negative polarity ensures that the voltage accumulated in the capacitor with the secondary output of the transformer is collected and transmitted to the magnetron as an open circuit. In this way, twice the secondary voltage occurs in the magnetron.

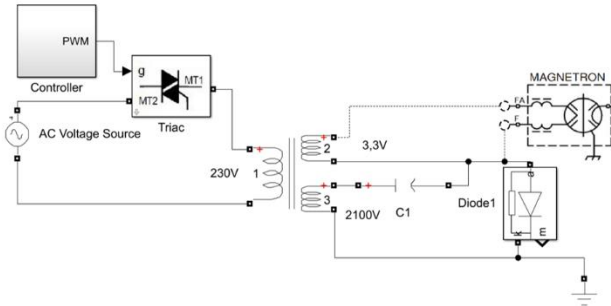

Figure 3. Microwave oven control diagram.

The power output of magnetrons in microwave ovens can be controlled using various methods such as variable voltage source, resistive, capacitive, ON-OFF (duty cycle), and phase controls [38, 39]. This study achieves duty cycle control using a zero-crossing Solid State Relay (SSR). The output of the SSR is activated after the zero crossing of the input signal when the drive signal is at a logic high level. Similarly, the SSR stays open until the zero crossing of the input when the driver signal is at a logic-low level and closes with the zero crossing. Figure 3 illustrates the microwave oven control diagram.

2.4. Temperature Measurement Method

Accurate temperature measurement is crucial in microwave systems, but several important factors must be considered. Figure 4a shows that microwave leaks occur at the entrance points of the thermocouple, which can affect the accuracy of the measurement. To mitigate this problem, the thermocouple should be electrically grounded to the surface of the microwave oven, as shown in Figure 4b. Additionally, microwave radiation can also impact thermocouple measurements and lead to errors. Coating the thermocouple is one solution to this issue, and Figure 4 illustrates three basic types of coatings. Figure 4c shows a coating that can withstand microwave radiation. In contrast, the coating in Figure 4d grounds the tip of the thermocouple to the body, and Figure 4e features an open that can be affected by radiation [24]. Therefore, the coating in Figure 4c is recommended to ensure accurate temperature measurements.

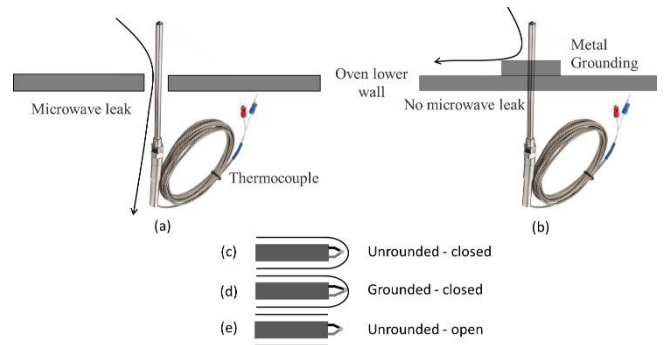

Figure 4. (a) Grounded, (b) ungrounded, (c,d,e) thermocouple coating of temperature measurement system.

2.5. Microwave Leakage Measurement

Microwave sources can cause health issues if not properly controlled, as they are absorbed by the human body and converted into heat energy. While this heat is often invisible at low levels, it can still lead to health problems, particularly in sensitive areas such as the brain, eyes, and genitals. To prevent such health risks, it is crucial to implement necessary safety measures and adhere to established standards in microwave systems [40].

The standards related to this subject specify the amount of power converted into heat in the unit tissue of the human body. This quantity is defined in terms of Specific Absorption Rate (SAR) as shown in the following Equation (3) [41]:

$$SAR = \frac{\sigma}{2\rho} |\vec{E}|^2 \frac{W}{kg} \tag{3}$$

Here,  $\sigma$  is tissue conductivity (S/m),  $\rho$  is tissue density (kg/m<sup>3</sup>), and  $E$  is the electric field in the tissue sample. This effect decreases rapidly with increasing distance and depends on the duration of exposure to the activity. As a result, the standards were determined according to 30 minutes for general exposure and 6 minutes for controlled workers (occupational). These values can also be given as PD (mW/cm<sup>2</sup>). The conversion between these two units is expressed in the following formula [42]:

$$SAR = \frac{d}{dt} \frac{dw}{dm} = \frac{d}{dt} \left( \frac{dw}{d(\rho \cdot V)} \right) = \frac{P}{\rho \cdot l \cdot dS} = \frac{P}{\rho \cdot l} \tag{4}$$

where  $V$  is the tissue volume,  $l$  is the tissue length,  $S$  is the tissue section,  $\rho$  is the tissue density, and  $P$  is the power density. Many countries have safety standards depending on the frequency. In the International Commission on Non-Ionizing Radiation Protection (ICNIRP) standard [43], PD reference levels for an average exposure time of 6 and 30 minutes to EM fields are given in Table 1. This study's PD value is expected to be lower than 50 W/m<sup>2</sup> since more than 6 minutes of exposure will be required for controlled use.

**Table 1.** ICNIRP (2020) PD limit values.

Effect Duration	Impact Type	Frequency Range	PD(W/cm <sup>2</sup> )
30 minutes	Controlled	2-300 GHz	50
30 minutes	General use	2-300 GHz	10
6 minutes	Controlled	2-6 GHz	200
6 minutes	General use	2-6 GHz	40

**3. Results and Discussion**

We performed a simulation to analyze the waveguide that would be produced with a value between 75 mm and 105 mm. Afterward, similar to design-1 and design-2, waveguides were installed in the oven and simulations were carried out for the same "a" value. Upon examination of the results of S<sub>21</sub> presented in Figure 5a, it was observed that the cut-off frequency of the waveguide was below 2.45 GHz when the "a" value ranged from 75 mm to 105 mm. When analyzing the S<sub>11</sub> graphs depicted in Figure 5a, it was noted that the back reflection was around -90 dB.

Designing microwave ovens with four magnetrons requires special attention to ensure that electromagnetic waves do not interfere with each other. An EM wave from one magnetron can cause others to heat up. To prevent this, simulation studies were conducted to determine the appropriate dimensions for the waveguide. As a result of the analyses, it was found that the long edge of the waveguide (short edge a, long edge b=2a) should be 101 mm. The S<sub>11</sub> reflection parameter was around -100 dB at the operating frequency of 2.45 GHz, as shown in Figure 5a. Additionally, the S<sub>21</sub> transmission parameter was found to be around 0 dB. These two parameters indicate that the waveguide is appropriately designed for the specified values.

**Table 2.** Comparison of multi-magnetron ovens.

Reference Number	Number of Magnetrons	PD (mW/cm <sup>2</sup> )	S <sub>21</sub> (dB)
Our work	4	0.37	-177
[26]	6	-	-
[27]	2	-	~45
[22]	4	2	-
[28]	2	-	-52
[24]	4	-	~25
[25]	4	-	~14

After determining the dimensions of the waveguide, the effect of their positioning relative to each other as in design-1 and design-2 was analysed. The results of these analyses are presented in Figure 5b. It was observed that for design-1, where the waveguides are positioned facing each other without making an angle, the S<sub>21</sub> parameter was relatively high at around -5 dB. This indicates that energy from one waveguide is reaching the other. On the other hand, for design-2, where the waveguides are positioned at 90° to each other, the S<sub>21</sub> parameter was found to be very low at around -177 dB, indicating very little electromagnetic energy from one waveguide is reaching the other. When examining other studies in the literature in Table 2, the closest S<sub>21</sub> value to our design is -52 dB. As can be understood from the table, it is seen that the proposed oven design eliminates the focusing problem and minimizes port-port interaction.

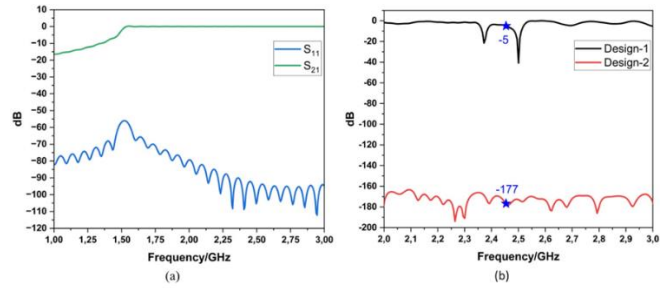

**Figure 5.** (a) Waveguide S parameters for a=101mm, (b) S<sub>21</sub> parameters for design-1 and design-2

Figure 6 shows the electric field distribution simulation results, which indicate that the waveguides are positioned correctly to prevent interference between the magnetrons. The effect of the EM waves from waveguides WG2, WG3, and WG4 on WG1 is approximately 1600 V/m. Similar results were obtained for the other waveguides. Therefore, the maximum electric field values created by the waveguides in the oven cavity are around 1748 V/m on average. It is seen that similar results were obtained in the study of Yi et al. [44].

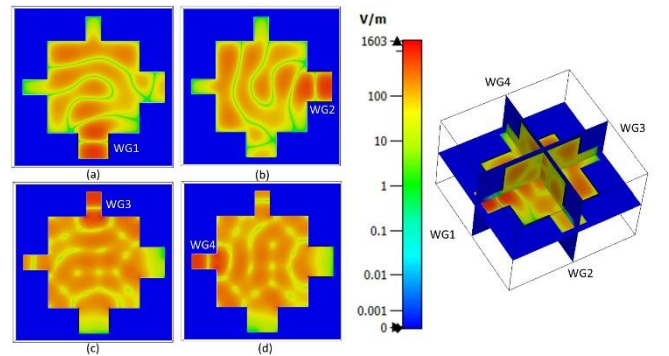
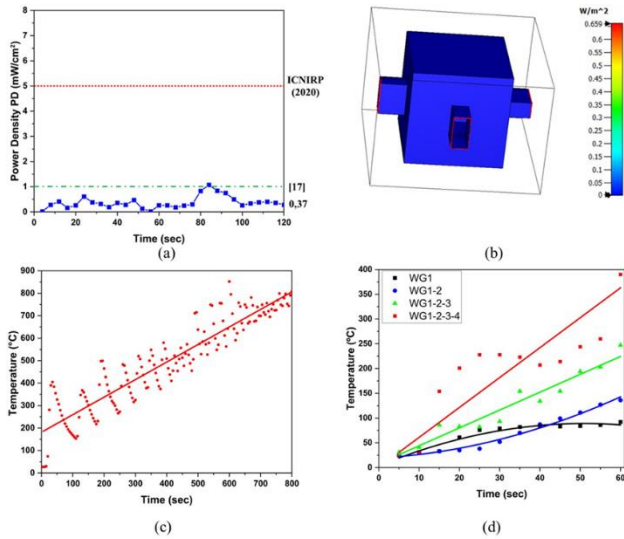

**Figure 6.** Electric field simulation results (WG shows which waveguide the EM wave entered)

The PD values obtained from CST analysis are presented in Figure 7a. Upon examination, it is observed that the maximum PD value is 0.066 mW/cm<sup>2</sup>. On the other hand, the measured PD values obtained from the measurements conducted at a distance of 5 cm from the produced oven are shown in Figure 7b. According to the figure, the maximum PD value measured was 1.07 mW/cm<sup>2</sup>, while the average PD value was 0.37 mW/cm<sup>2</sup>. As seen in Table 2, compared with other studies in the literature, our proposal has more suitable PD values for human health. Also, it complies with the ICNIRP (2020) standard provided in Table 1.

The microwave oven was programmed to reach a temperature of 800°C within 800 seconds. Temperature measurements were conducted using the system depicted in Figure 3. Figure 7c shows that the microwave oven can reach the desired high temperature values within the expected time frame. The peaks observed in the graph are because the measurements were taken at 5-second intervals, and the magnetrons suddenly generate a lot of heat. Figure 7d displays the temperature measurements obtained by gradually increasing the number of operating magnetrons. As the figure shows,

while a single magnetron heats up to about 90°C, two magnetrons heat up to 130°C, three magnetrons heat up to about 200°C, and four magnetrons heat up to about 390°C.



**Figure 7.** a) PD measurement result, b) PD simulation result, c) temperature measurement result, d) temperature measurement result according to the number of magnetrons

#### 4. Conclusion

This study has examined the design, manufacture, and performance of multi-magnetron ovens capable of reaching high temperatures. Firstly, an appropriate waveguide was simulated, and the production process was completed. Then, the proposed designs for multi-magnetron ovens were simulated, and appropriate dimensions were suggested. It was reported that the average power density (PD) value of the produced multi-magnetron oven was 0.37 mW/cm<sup>2</sup>, which indicates its performance and efficiency. This value was found to be compliant with standards and safe for human use. The main objective of our study was to demonstrate that waveguides can reach high temperatures at the center of the oven without affecting each other. In this context, it was observed that the temperature created by magnetrons operating in single, double, triple, and quadruple modes gradually increased at the center of the oven. The simulation results supporting this showed that the S<sub>21</sub> parameter was -177dB. The design proposed and applied in our study was efficient, easy to produce, safe for human use, low cost, and usable in commercial and academic studies for reaching high temperatures.

#### Author contributions

**Ahmet Özmen:** Conceptualization, Methodology, Visualization, Validation, Writing. **Aykut Coşkun:** Data curation, Writing-Reviewing and Editing Software, Validation. **Mehmet Ertuğrul:** Visualization, Investigation, Writing-Reviewing and Editing.

#### Conflicts of interest

The authors declare no conflicts of interest.

#### References

1. Yoğurtçu, H. (2019). Optimization of microwave apple drying using response surface method. *Journal of the Faculty of Engineering and Architecture of Gazi University*, 34(3), 1365–1376. <https://doi.org/10.17341/gazimmfd.460532>
2. Zhou, X., Zhang, S., Tang, Z., Tang, J., & Takhar, P. S. (2022). Microwave frying and post-frying of French fries. *Food Research International*, 159(May), 111663. <https://doi.org/10.1016/j.foodres.2022.111663>
3. Shen, L., Gao, M., Feng, S., Ma, W., Zhang, Y., Liu, C., Liu, C., & Zheng, X. (2022). Analysis of heating uniformity considering microwave transmission in stacked bulk of granular materials on a turntable in microwave ovens. *Journal of Food Engineering*, 319(600), 110903. <https://doi.org/10.1016/j.jfoodeng.2021.110903>
4. Du, M., Zhang, Z., Huang, J., Zhu, H., & Yang, Y. (2023). Study of multi-frequency heating based on the nonlinear response characteristics of magnetron to improve uniformity. *Journal of Microwave Power and Electromagnetic Energy*, 57(1), 71–88. <https://doi.org/10.1080/08327823.2023.2166003>
5. Receptoğlu, Y. K., Gümüşbulut, G., & Özşen, A. Y. (2023). A comparative assessment for efficient oleuropein extraction from olive leaf (*Olea europaea L. folium*). *Turkish Journal of Engineering*, 7(2), 116–124. <https://doi.org/10.31127/tuje.1058500>
6. Detz, R. J., & Zwaan, B. van der. (2020). Surfing the microwave oven learning curve. *Journal of Cleaner Production*, 271, 122278. <https://doi.org/10.1016/j.jclepro.2020.122278>
7. Liu, Y., Guo, N., Yin, P., & Zhang, C. (2019). Facile growth of carbon nanotubes using microwave ovens: The emerging application of highly efficient domestic plasma reactors. In *Nanoscale Advances*, 1(12), 4546–4559. <https://doi.org/10.1039/c9na00538b>
8. Liew, K. M., & Yuan, J. (2011). High-temperature thermal stability and axial compressive properties of a coaxial carbon nanotube inside a boron nitride nanotube. *Nanotechnology*, 22(8), 085701. <https://doi.org/10.1088/0957-484/22/8/085701>
9. Fazzolari, F. A. (2018). Thermoelastic vibration and stability of temperature-dependent carbon nanotube-reinforced composite plates. *Composite Structures*, 196(April), 199–214. <https://doi.org/10.1016/j.compstruct.2018.04.026>
10. Asnawi, M., Azhari, S., Hamidon, M. N., Ismail, I., & Helina, I. (2018). Synthesis of Carbon Nanomaterials from Rice Husk via Microwave Oven. *Journal of Nanomaterials*, 2018(1), 1–5. <https://doi.org/10.1155/2018/2898326>
11. Liu, Z., Wang, J., Kushvaha, V., Poyraz, S., Tippur, H., Park, S., Kim, M., Liu, Y., Bar, J., Chen, H., & Zhang, X. (2011). Poptube approach for ultrafast carbon nanotube growth. *Chemical Communications*, 47(35), 9912. <https://doi.org/10.1039/c1cc13359d>
12. Bajpai, R., & Wagner, H. D. (2015). Fast growth of carbon nanotubes using a microwave oven. *Carbon*,

- 82(C),327–336.  
<https://doi.org/10.1016/j.carbon.2014.10.077>
13. Barman, B. K., & Nanda, K. K. (2018). Ultrafast-Versatile-Domestic-Microwave-Oven Based Graphene Oxide Reactor for the Synthesis of Highly Efficient Graphene Based Hybrid Electrocatalysts. *ACS Sustainable Chemistry and Engineering*, 6(3), 4037–4045.  
<https://doi.org/10.1021/acssuschemeng.7b04398>
  14. Pang, F. (2018). Note: A compact microwave plasma enhanced chemical vapor deposition based on a household microwave oven. *Review of Scientific Instruments*, 89(8), 086104.  
<https://doi.org/10.1063/1.5040699>
  15. Sun, Y., Yang, L., Xia, K., Liu, H., Han, D., Zhang, Y., & Zhang, J. (2018). “Snowing” Graphene using Microwave Ovens. *Advanced Materials*, 30(40), 1803189.  
<https://doi.org/10.1002/adma.201803189>
  16. Nadkarni, R. A. (1984). Applications of Microwave Oven Samole Dissolution in Analysis. 2233–2237.
  17. Dadras, S., & Ghavamipour, M. (2018). Properties of YBCO high temperature superconductor synthesized by microwave oven. *Materials Research Express*, 5(1). <https://doi.org/10.1088/2053-1591/aaa5eb>
  18. Gray, R. J., Jaafar, A. H., Verrelli, E., & Kemp, N. T. (2018). Method to reduce the formation of crystallites in ZnO nanorod thin-films grown via ultra-fast microwave heating. *Thin Solid Films*, 662, 116–122.  
<https://doi.org/10.1016/j.tsf.2018.07.034>
  19. Shahiduzzaman, M., Yamada, R., Chikamatsu, T., Ono, T., Tanaka, Y., Uesugi, Y., Karakawa, M., Kuwabara, T., Takahashi, K., Ishijima, T., & Taima, T. (2019). Thin film deposition method for ZnO nanosheets using low-temperature microwave-excited atmospheric pressure plasma jet. *Thin Solid Films*, 674, 58–63.  
<https://doi.org/10.1016/j.tsf.2019.01.053>
  20. Nirmal Peiris, T. A., Sagu, J. S., Hazim Yusof, Y., & Upul Wijayantha, K. G. (2015). Microwave-assisted low temperature fabrication of ZnO thin film electrodes for solar energy harvesting. *Thin Solid Films*, 590, 293–298.  
<https://doi.org/10.1016/j.tsf.2015.08.008>
  21. Pérez-Conesa, I., Fayos-Fernández, J., Aguilar Galea, J. A., Monzó-Cabrera, J., & Pérez-Campos, R. (2022). Evaluation of graphite and TiO<sub>2</sub> as susceptors for microwave dewaxing in ceramic shell casting processes of artworks. *Journal of Microwave Power and Electromagnetic Energy*, 56(3), 201–215.  
<https://doi.org/10.1080/08327823.2022.2106730>
  22. Jie, X., Li, W., Slocombe, D., Gao, Y., Banerjee, I., Gonzalez-Cortes, S., Yao, B., AlMegren, H., Alshihri, S., Dilworth, J., Thomas, J., Xiao, T., & Edwards, P. (2020). Microwave-initiated catalytic deconstruction of plastic waste into hydrogen and high-value carbons. *Nature Catalysis*, 3(11), 902–912. <https://doi.org/10.1038/s41929-020-00518-5>
  23. Boonthum, D., Chanprateep, S., Ruttanapun, C., & Nisoa, M. (2019). Development of high-temperature multi-magnetron microwave furnace for material processing. *Songklanakarinn Journal of Science and Technology*, 41(3), 494–500.  
<https://doi.org/10.14456/sjst-psu.2019.69>
  24. Horikoshi, S., Schiffmann, R. F., Fukushima, J., & Nick, S. (1981). Microwave Chemical and Materials Processing. In *The Physics Teacher* (Vol. 19, Issue 1). <https://doi.org/10.1119/1.2340686>
  25. Chen, X., Yang, B., Shinohara, N., & Liu, C. (2020). A High-Efficiency Microwave Power Combining System Based on Frequency-Tuning Injection-Locked Magnetrons. *IEEE Transactions on Electron Devices*, 67(10), 4447–4452.  
<https://doi.org/10.1109/TED.2020.3013510>
  26. Kim, J. K., Kim, Y. S., & Jeon, E. S. (2019). Experimental Study on Flat-Glass Heating and Edge-Sealing Using Multiple Microwave Sources. *Energies*, 12(22), 4359.  
<https://doi.org/10.3390/en12224359>
  27. Zhang, Y., Huang, K., Agrawal, D. K., Slawacki, T., Zhu, H., & Yang, Y. (2017). Microwave Power System Based on a Combination of Two Magnetrons. *IEEE Transactions on Electron Devices*, 64(10), 4272–4278. <https://doi.org/10.1109/TED.2017.2737555>
  28. Rajpurohit, D. S., & Chhibber, R. (2016). Design Optimization of Two Input Multimode Applicator for Efficient Microwave Heating. *International Journal of Advances in Microwave Technology*, 1(3), 68–73.
  29. Bouzit, A., Chraygane, M., El Ghazal, N., Ferfra, M., & Bassoui, M. (2014). Modeling of New Single-Phase High Voltage Power Supply for Industrial Microwave Generators for N=2 Magnetrons. *International Journal of Electrical and Computer Engineering (IJECE)*, 4(2), 223–230.  
<https://doi.org/10.11591/ijece.v4i2.5686>
  30. Bassoui, M., Ferfra, M., Chraygane, M., & Bahani, B. (2014). Optimization under Matlab Simulink code of a three-phase HV power transformer for microwaves generators supplying one magnetron by phase. *Proceedings of 2014 Mediterranean Microwave Symposium (MMS2014)*, 2015-April(February2016), 1–6.  
<https://doi.org/10.1109/MMS.2014.7088787>
  31. Boubker, B., Bouzit, A., Chraygane, M., Ferfra, M., El Ghazal, N., & Belhaiba, A. (2013). Modeling of a New Single-Phase High Voltage Power Supply for Microwave Generators with Three Magnetrons. *International Journal of Electrical and Computer Engineering (IJECE)*, 3(2), 164–170.  
<https://doi.org/10.11591/ijece.v3i2.2238>
  32. El, N., -, A. B., -, M. C., & -, B. B. (2013). New Simulation Method of New HV Power Supply for Industrial Microwave Generators with N=2 Magnetrons. *International Journal of Advanced Computer Science and Applications*, 4(12), 55–64.  
<https://doi.org/10.14569/IJACSA.2013.041209>
  33. Mekonnen, S. A., & Yenikaya, S. (2019). Design optimization using dielectric slab for efficient microwave heating. *Turkish Journal Of Electrical Engineering & Computer Sciences*, 27(4), 3055–3064. <https://doi.org/10.3906/elk-1802-164>
  34. Yuanyuan, W., Junqing, L., Fengming, Y., Tao, H., Yang, Y., Huacheng, Z., & Zhengming, T. (2021).

- Study of the high heating efficiency and uniformity by multi-port sweep frequency microwave irradiations. *Journal of Microwave Power and Electromagnetic Energy*, 55(4), 316–332. <https://doi.org/10.1080/08327823.2021.1993044>
35. Horikoshi, S., & Serpone, N. (2011). Microwave Frequency Effect(s) in Organic Chemistry. *Mini-Reviews in Organic Chemistry*, 8(3), 299–305. <https://doi.org/10.2174/157019311796197436>
  36. Kahveci, B., Özil, M., & Mentese, E. (2015). *Mikroalga Destekli Organik Senteze Giriş. Gazi Kitapevi*.
  37. Guo, L., Liu, C., Srinivasakannan, C., & Jiyun, G. (2021). Microwave upgradation of Yunnan lignite: dielectric properties, drying pattern and kinetics. *Journal of Microwave Power and Electromagnetic Energy*, 55(3), 248–269. <https://doi.org/10.1080/08327823.2021.1952834>
  38. TIGLI, İ. (2014). Mutfak tipi bir mikroalga fırının mikroişlemci ile kontrolü. 16(2), 87–99.
  39. Li, Z. (2004). Design of a Microcontroller-based , Power Control System for Microwave Drying. December, 90.
  40. Geyikoğlu, M. D., Koç Polat, H., Kaburcuk, F., & Çavuşoğlu, B. (2020). SAR analysis of tri-band antennas for a 5G eyewear device. *International Journal of Microwave and Wireless Technologies*, 12(8), 754–761.
  41. Özyalçın, M. O., Akleman, F., & Sevgi, L. (2002). Sar simulations in wireless communication and safety discussions in the society. *Turkish Journal of Electrical Engineering and Computer Sciences*, 10(2), 411–426.
  42. Popov, V., & Shevchenko, A. (2019). Analysis of standards and norms of electromagnetic irradiation levels in wireless communication systems on railway transport. *Procedia Computer Science*, 149, 239–245. <https://doi.org/10.1016/j.procs.2019.01.129>
  43. ICNIRP. (2020). Guidelines for Limiting Exposure to Electromagnetic Fields (100 kHz to 300 GHz). *Health Physics*, 118(5), 483–524. <https://doi.org/10.1097/HP.0000000000001210>
  44. Yi, Z., Qiu, W., Jiao, Y., Row, K. H., Cheng, Y. dong, & Jin, Y. (2021). Calculation of electric field and temperature distribution within a microwave oven with realistic geometric features geometric features using numeric simulations. *Journal of Microwave Power and Electromagnetic Energy*, 55(1), 3–27. <https://doi.org/10.1080/08327823.2020.1838048>



© Author(s) 2024. This work is distributed under <https://creativecommons.org/licenses/by-sa/4.0/>