

## Effect of Welding Parameters on Pull-through Load in Projection Welding of M4 Nut to Hot Rolled Low Carbon Steel Sheet

Mustafa Yazar<sup>1,\*</sup>, Şükrü Talaş<sup>2</sup>, Hilal Kır<sup>3</sup>

<sup>1</sup> R&D Department, Şahinkul Machine and Spare Parts Manufacturing Co. Ltd., Bursa, Türkiye

<sup>2</sup> Afyon Kocatepe University, Faculty of Technology, Department of Metallurgical and Materials Engineering, Türkiye

<sup>3</sup> Bursa Uludağ University, Department of Mechanical Engineering, Bursa, Türkiye

### ARTICLE INFORMATION

Received: 13.08.2024

Accepted: 30.10.2024

#### Keywords:

Projection welding

M4 weld nut

WSS-M1A365-A22 steel  
sheet

### ABSTRACT

Projection welding is frequently used in automotive industry for its practicality in application and also help complex parts to be welded fast enough to reduce labour intensive processing. This study investigates the effect of parameters of projection welding on the weldability performance of dissimilar steels of hot rolled Low Carbon steel (WSS-M1A365-A22) sheet to M4 steel nuts in the projection welding operation. The aim of this study was to improve product quality by examining the fracture load within the minimum and maximum value range specified by the automotive industry. In this study, the effect of welding parameters on the quality of the projection weld of M4 weld nut on steel sheet was investigated using a 100 kVA projection welding machine with UNIS brand MFDC (Mid Frequency Direct Current) transformer. The samples underwent a tensile snap force test using a fully destructive testing device. The tests used a 3 mm WSS-M1A365-A22 steel sheet and M4 DIN 928 welding nut. The current value, welding time, and electrode compression force were varied to determine the optimal conditions. The results showed that a current value of 14.5 kA, welding time of 23 ms, and electrode compression force of 480 dAN met the pull-through load conditions.

## M4 Somununun Sıcak Haddelenmiş Düşük Karbonlu Çelik Sac Üzerine Projeksiyon Kaynağında Kaynak Parametrelerinin Çekme Yükü Üzerindeki Etkisi

### MAKALE BİLGİSİ

Alınma: 13.08.2024

Kabul: 30.10.2024

#### Anahtar Kelimeler:

Projeksiyon kaynağı

M4 kaynak somunu

WSS-M1A365-A22 çelik sac

### ÖZET

Projeksiyon kaynak yöntemi, uygulama kolaylığı nedeniyle otomotiv endüstrisinde sıkça kullanılmaktadır ve karmaşık parçaların hızlı bir şekilde kaynaklanmasına olanak tanıyarak iş gücü yoğun işlemleri azaltmaya yardımcı olur. Bu çalışma, sıcak haddelenmiş Düşük Karbonlu çelik (WSS-M1A365-A22) sac ile M4 çelik somunların projeksiyon kaynak işlemi sırasında kaynaklanabilirlik performansı üzerindeki parametrelerin etkisini incelemektedir. Çalışmanın amacı, otomotiv endüstrisi tarafından belirtilen minimum ve maksimum değer aralığı içindeki kırılma yükünü inceleyerek ürün kalitesini artırmaktır. Bu çalışmada, M4 kaynak somununun çelik sac üzerine projeksiyon kaynağında kaynak parametrelerinin kalitesi üzerindeki etkisi, UNIS markalı MFDC (Orta Frekans Doğru Akım) transformatörlü 100 kVA projeksiyon kaynak makinesi kullanılarak araştırılmıştır. Örnekler, tamamen yıkıcı bir test cihazı kullanılarak çekme kopma kuvveti testine tabi tutulmuştur. Testlerde 3 mm WSS-M1A365-A22 çelik sac ve M4 DIN 928 kaynak somunu kullanılmıştır. Optimum koşulları belirlemek için akım değeri, kaynak süresi ve elektrot sıkıştırma kuvveti değiştirilmiştir. Sonuçlar, 14.5 kA akım değeri, 23 ms kaynak süresi ve 480 dAN elektrot sıkıştırma kuvvetinin çekme yükü koşullarını karşıladığını göstermiştir.

\*Corresponding author, e-mail: mustafa.yazar@sahinkulmakina.com.tr

To cite this article: M. Yazar, Ş. Talaş, H. Kır, Effect of Welding Parameters on Pull-through Load in Projection Welding of M4 Nut to Hot Rolled Low Carbon Steel Sheet, Manufacturing Technologies and Applications,5(3), 224-236, 2024.

<https://doi.org/10.52795/mateca.1549603>, This paper is licensed under a CC BY-NC 4.0

## 1. INTRODUCTION (GİRİŞ)

In today's increasingly competitive environment, local companies need to produce low-cost and good-quality products to compete with the high-capacity producers formed by major industries. Reducing the active weights of vehicles to save fuel is not a new topic, but it is continuously being worked on in order to make it more efficient way of consuming less petrol. One of the ways of reducing the carbon footprint is through using high strength steels with reduced thickness in automotive industry [1-3]. New generation steel grades, known as Advanced High Strength Steels (AHSS), are being developed alongside the rapid progress in the steel industry [4]. Weldability with high-strength steels has become important in this regard [5-7]. In the automotive sector, the advantages of using joining elements are low cost, ease of design, quick and easy assembly, and adherence to manufacturing standards. Similar to resistance spot welding processes, the resistance projection welding is one of the widely used joining methods in many industrial fields today [8, 9]. It is a highly efficient and versatile form of short time resistance spot welding that offers numerous advantages for various industrial applications [10]. This welding method focuses the weld current and compression force onto a single point or line at the beginning of a weld, allowing for the welding of multiple projections on a workpiece [11-14]. The process of projection welding involves the generation of high heat through welding projections, which then melt and form a welded joint between components. Unlike in resistance spot welding, the welding projections themselves control the resistance and welding heat input in projection welding. One of the key advantages of projection welding is its efficiency, as multiple projections can be welded in one shot, saving time and increasing productivity [13,14]. Projection welding allows for the welding of various types of projections like circular, round dimples, extended corners, rib type, or elongated ridges of weld nuts [15]. Studies in the literature mostly focus on the different sheet thicknesses and welding parameters (welding current). There has been a growing interest in the impact of welding parameters (such as the number of impulses, the duration of the source, and the electrode compression force) on the mechanical properties of new generation steels [16]. Numerous studies investigated the resistance projection welding of various types of weld nuts, using both direct-current (DC) and alternating-current (AC) power sources [15-17]. These studies have revealed significant differences in the pull-out strength of joints welded with different power sources [18]. It has been discovered that a rapid current build-up during the initial welding period in alternating current machines enhances the initial heating of the projections and subsequently increases the strength of the joint due to efficient heating [16]. However, in relation to the nugget formation, the current type generates different nugget sizes such as AC current produces larger nugget size whereas DC current generates more homogeneous nugget in resistance spot welds [15-18].

Although, the welding of advanced high strength steels against medium carbon steels have been studied by many researchers, however, the use of projection welding technique in joining these two dissimilar steels lacks in investigation, hence this study is aimed to fill this gap from the perspective of compression force, weld time and weld current on the mechanical properties of the welds. This study broadly deals with the weldability issue between low carbon steel similar to SAE101 containing 0.3 wt% Ti and 0.2 wt% Cu and medium carbon M4 nut welded by projection welding. Various characterization techniques have been used to determine the mechanical properties of welds carried out with different parameters.

## 2. MATERIAL AND METHOD (MATERYAL VE YÖNTEM)

### 2.1. Materials (Malzemeler)

#### 2.1.1. 3 mm WSS-M1A365-A22 steel sheet material and M4 DIN 928 weld nut

The chemical composition and mechanical properties of 3 mm thick uncoated commercial WSS-M1A365-A22 (similar to SAE1010 steel) hot dip zinc coated hot rolled low carbon steel sheet used in the experiments are shown in Table 1 and Table 2, respectively. WSS-M1A365-A22 steel sheet with a thickness of 3 mm is shown in Figure 1.

Table 1. Chemical analysis of 3 mm WSS-M1A365-A22 steel sheet (wt.%)

Element	C	Si	Mn	P	S	Al	Ti	Cu	Fe
wt %	0.10	0.50	0.50	0.02	0.03	0.015	0.3	0.2	Bal.

Table 2. Mechanical properties of 3 mm WSS-M1A365-A22 steel sheet

Material	Yield Strength (MPa)	Tensile Strength (MPa)	Elongation (%)
3 mm WSS-M1A365-A22	180-290	400	34

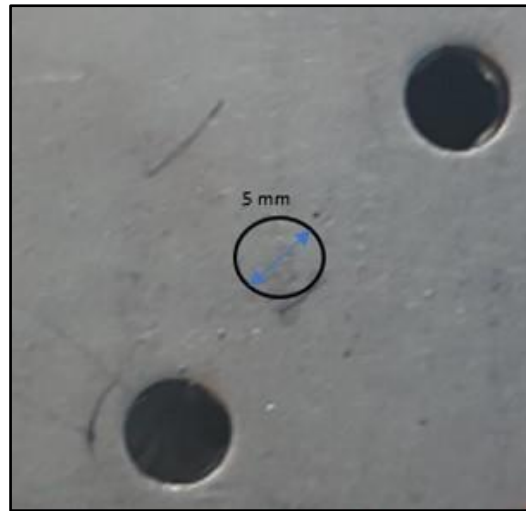

Figure 1. Test setup for 3 mm WSS-M1A365-A22 steel sheet material

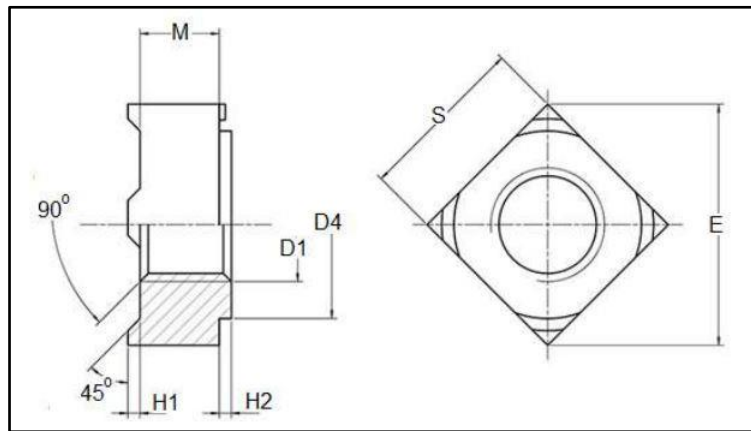

Figure 2. M4 DIN 928 weld nut (M4 DIN 928 kaynak somunu)

Table 3. M4 DIN 928 weld nut scales

Unit	E	S	M	D4	H1	H2
mm	9	7	3.5	6.4	0.6	0.4

Table 4. Chemical properties of M4 DIN 928 weld nut

Element	C	Mn	Si	P	S	Fe
wt.%	0.55	0.6	0.3	0.05	0.06	Bal.

Table 5. Mechanical properties of M4 DIN 928 weld nut

Material	Tensile Strength (MPa)	Hardness (HV)
M4 DIN 928 Weld Nut	600	190

The M4 DIN 928 weld nut used in the experiments is shown in Figure 2 and its dimensions are given in Table 3. Chemical properties of M4 DIN 928 weld nut are given in Table 4 and physical properties are given in Table 5.

## 2.2. Spot Welding Operation with Method Projection Welding (Projeksiyon Kaynak Yöntemi ile Punta Kaynak Operasyonu)

In projection welding, a) control of water and air flow rate, b) control of electrode force and current values, c) axial levelling control should be carried out in 100 kVA fixed projection spot welding machine with MFDC transformer before welding. Figure 3a shows the general view of Tecna welding test machine and Figure 3b shows the accuracy of the welding current value and Figure 3c shows the accuracy of the compression force. These steps must be intermittently performed before the welding process starts.

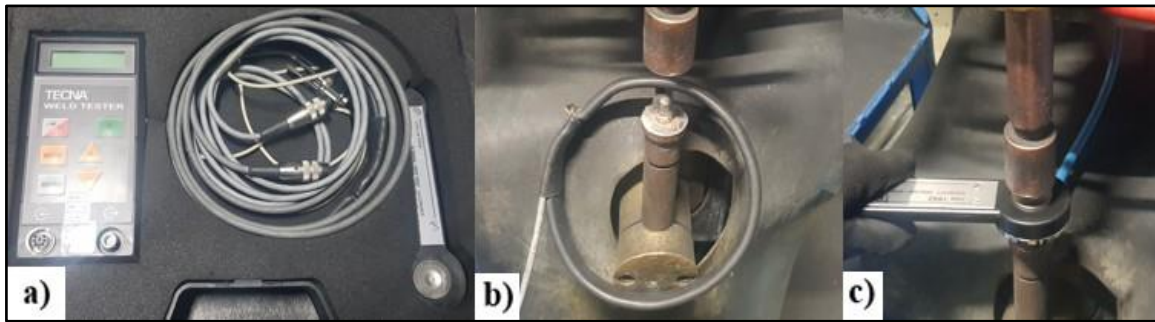

Figure 3. a) Tecna weld tester, b) current testing c) force testing (a) Tecna kaynak test cihazı, b) akım testi, c) kuvvet testi)

In the experimental stage, the pulse value, which is one of the welding parameters, is taken as fixed during projection spot welding of nut. The projection weld of nut is shown in Figure 4. Figure 5 shows the application of projection welding under factory conditions. In the stages of projection welding, firstly the pin is fixed, then the nut is placed on the pin and tightened and then the welding process is carried out with the application of current. Welding 4 nozzle nut must be in the width, length and height specified in the specification [4]. If there is no weld protrusion in the weld nut or 4 welding nozzles are not equal, the desired rupture load value cannot be achieved.

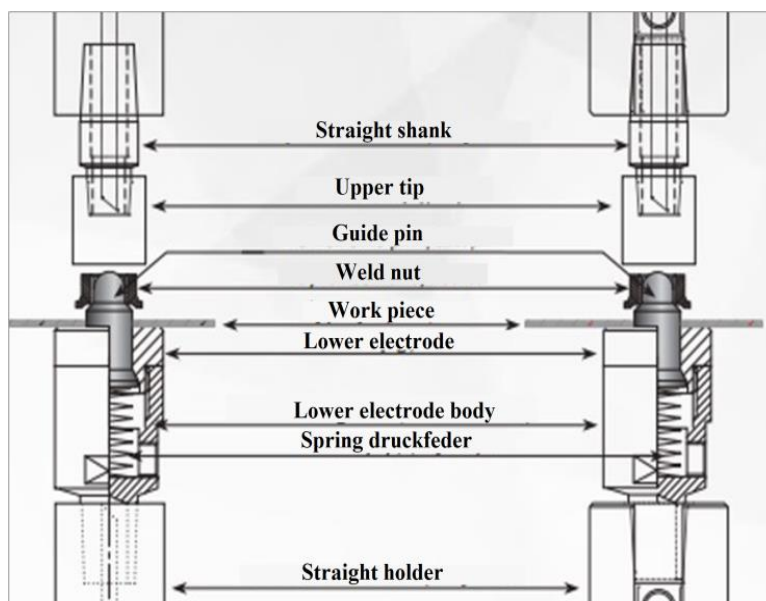

Figure 4. Weld nut projection welding process apparatus [19]

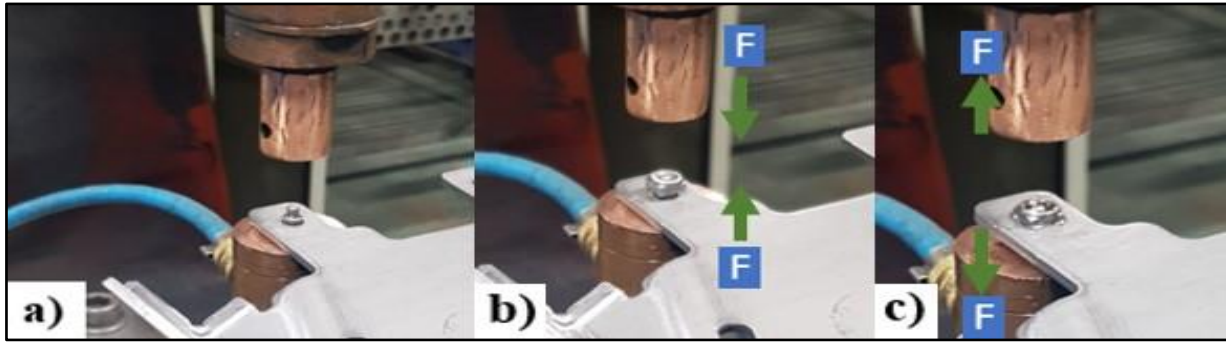

Figure 5. a) Aligning of sheet metal, b) application of compressing on nut and, c) completion of welding process

### 2.2.1. Current range for projection spot welding

In order to investigate the effect of current values on weld quality, 6 tests were performed at 10.5 kA, 12.5 kA, 14.5 kA, 16.5 kA, 18.5 kA, 20.5 kA and 2xM4 DIN 928 weld nuts were centred on each test piece. In this test set, welding time, welding current pulse application and welding clamping force were kept constant. The projection welding parameters are given in Table 6.

Table 6. Current range for M4 DIN 928 spot weld nut

Specimen No:	Weld time (ms)	Current (kA)	Electrode Force (daN)	Pulse
1	23	10.5	460	1
2	23	12.5	460	1
3	23	14.5	460	1
4	23	16.5	460	1
5	23	18.5	460	1
6	23	20.5	460	1

### 2.2.2. Weld time range for projection spot weld

In the second set of experiments, welding time, welding compression force, and impulse value were kept constant and 6 tests were carried out by applying welding time as 17 ms, 19 ms, 21 ms, 23 ms, 25 ms, 27 ms. In each test piece, two M4 DIN 928 weld nuts were projection welded. Projection welding parameters are given in Table 7.

Table 7. Welding time projection spot welding range for M4 DIN 928 weld nut

Specimen No:	Weld time (ms)	Current (kA)	Electrode force (daN)	Pulse
1	17	16.5	460	1
2	19	16.5	460	1
3	21	16.5	460	1
4	23	16.5	460	1
5	25	16.5	460	1
6	27	16.5	460	1

### 2.2.3. Electrode clamping force range for projection spot welding

In the third test set, the electrode force range was selected as 420 daN, 440 daN, 460 daN, 480 daN, 500 daN, 520 daN and weld time, weld current and weld pulse value were kept constant. In this test set, 6 tests were performed and 2 x M4 DIN 928 weld nuts were centred in each test piece. The projection weld parameters in this test set are given in Table 8.

**Table 8.** Welding force study parameters for the projection welding for M4 DIN 928 weld nut

Specimen No	Weld time (ms)	Current (kA)	Electrode Force (daN)	Pulse
1	23	16.5	420	1
2	23	16.5	440	1
3	23	16.5	460	1
4	23	16.5	480	1
5	23	16.5	500	1
6	23	16.5	520	1

### 2.3. Fracture Force Test (the pull-through tests) (Kopma Kuvveti Testi (çekme testi))

The fracture/pull through load test of the weld nuts, which were centred with different parametric values, was carried out in a fully destructive manner. Table 9 shows the technical specifications of the equipment for the pull-through test machine and Figure 6 shows the fracture or pull-through test process. For each test series, the pull-through test was performed in accordance with the relevant specifications and the measured values were averaged. This type of loading of the resistance projection welded nuts may not fully represent how the loads are applied in actual chassis applications. The weld nut is mounted on the back side of the sheet (see Figure 6), which generally is of thicker material than the surrounding sheet components. In this manner, the nut has to be pulled through the sheet at extreme loading conditions, something that, of course, increases the strength of the overall screw joint significantly. One type of M4 threaded weld nut with four separate projections was tested in the pull-through tests.

Table 9. Specifications of tensile pull-through tester (Çekme test cihazının teknik özellikleri)

Equipment	Power	Load	Dial
Pull-through tester	1.5 kW	20 kN	Digital

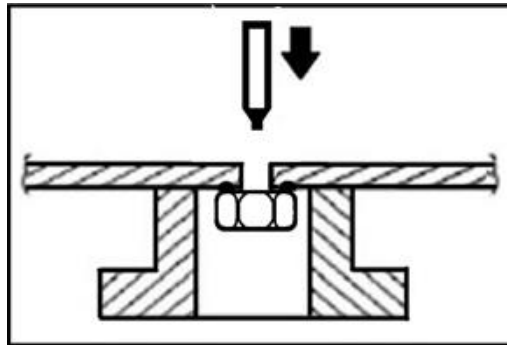

Figure 6. Principle of testing of projection welded nuts (Projeksiyon kaynaklı somunların test prensibi)

## 3. RESULTS AND DISCUSSION (SONUÇLAR VE TARTIŞMA)

### 3.1. Mechanical Properties (Mekanik Özellikler)

#### 3.1.1. Current controlled projection spot welding

The test process was carried out by increasing the current value by 2 kA in each test set. Two weld nuts were welded to the specimens prepared from WSS-M1A365-A22 steel sheets. After the weld nut projection welding, the results of the pull-through load forces were compared as a result of the full destructive test. After the weld nut projection welding operation was performed on the prepared test piece, a full destructive pull-through tensile test was performed and the test results are given in Table 10. According to the results, the pull-through stress was very low for welds with 10.5 kA and the average pull-through stress values increased as the welding current value increased.



Table 10. Tensile pull-through force test results of M4 DIN 928 weld nut welded with varying current (Standard deviations are given in brackets)

Specimen No	Current (kA)	Average tensile pull-through values (daN)
1	10.5	92.5 ( $\pm 6.14$ )
2	12.5	181.5 ( $\pm 16.21$ )
3	14.5	547 ( $\pm 33.03$ )
4	16.5	774 ( $\pm 45.43$ )
5	18.5	1110.5 ( $\pm 111.42$ )
6	20.5	1106.5 ( $\pm 104.85$ )

The average pull-through tensile loads at the lowest current value of 10.5 kA was 92.5 daN, the average pull-through load value at 20.5 kA was 1106.5 daN, and the average pull-through tensile load at 16.5 kA was 774 daN. When correlated with the current value, it was observed that the average pull-through tensile loads were affected by the welding current. In the specimen images of the tests carried out before and after welding process (Figures 7 and Figure 8), it is seen that with increasing welding current, more tearing occurs and especially the welds made with 16.5 kA, 18.5 and 20.5 kA welding current cause more fractures and tears. The failure in the form of tearing starts at the weld metal-heat affected zone boundary and continues to base metal, providing enough evidence to show that the heat affected zone in the sheet metal is more prone to defects resulting from high heat input which may have caused grain coarsening as it is frequently seen in these processes.

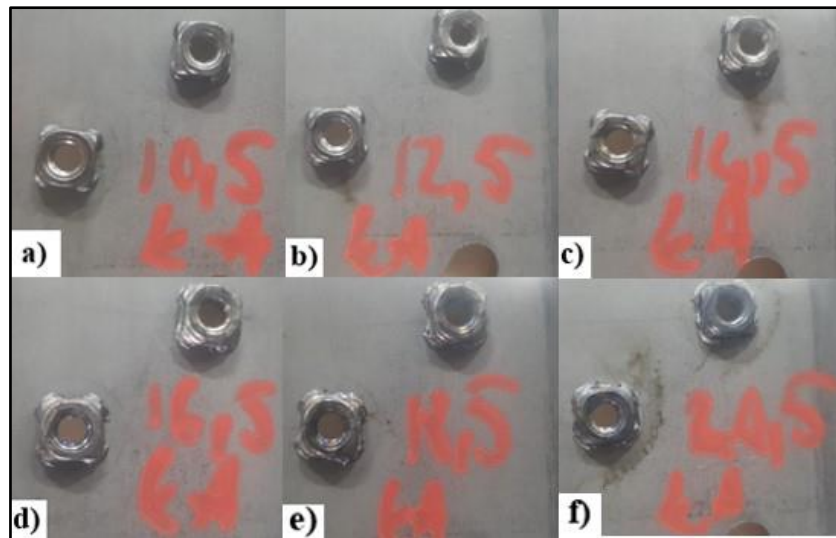

Figure 7. Images of test specimens after projection weld operation carried out at different weld currents: a) 10.5kA, b) 12.5 kA, c) 14.5 kA, d) 16.5 kA, e) 18.5 kA and f) 20.5 kA

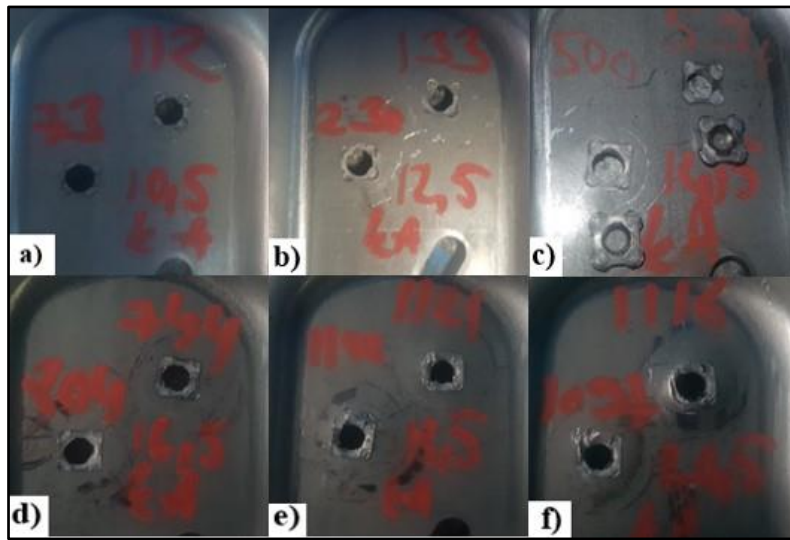

Figure 9. Images of pull-through tested specimens produced at different weld currents: a) 10.5kA, b) 12.5 kA, c) 14.5 kA, d) 16.5 kA, e) 18.5 kA and f) 20.5 kA.

Table 11. Average pull-through load values for M4 DIN 928 weld nut for different weld times (Standard deviations are given in brackets)

Specimen No	Weld time (ms)	Average pull-through force (daN)
1	17	778.2 ( $\pm 43.82$ )
2	19	694.5 ( $\pm 39.24$ )
3	21	651.5 ( $\pm 33.31$ )
4	23	797 ( $\pm 40.84$ )
5	25	548 ( $\pm 30.73$ )
6	27	615 ( $\pm 29.37$ )

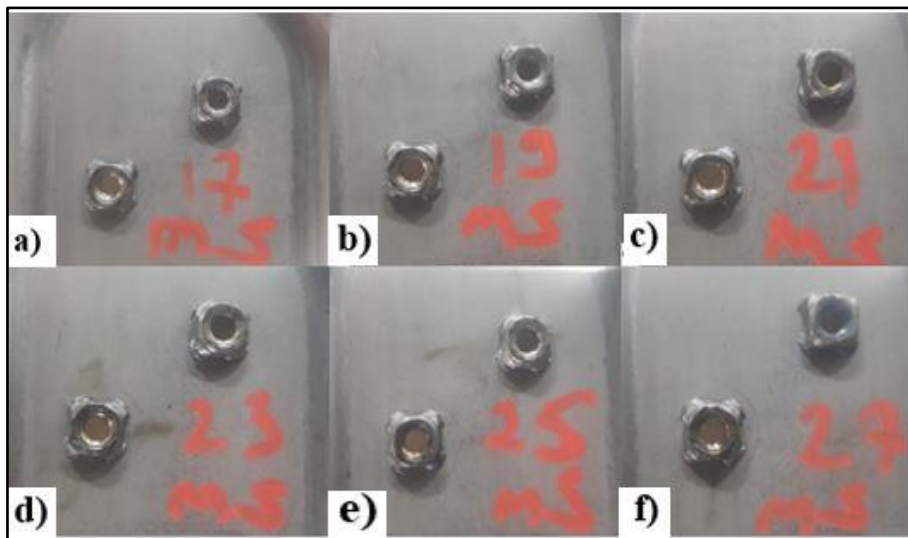

Figure 9. Images of test specimens after projection welding operation carried out at different weld time: a) 17 ms, b) 19 ms, c) 21 ms, d) 23 ms, e) 25 ms and f) 27 ms



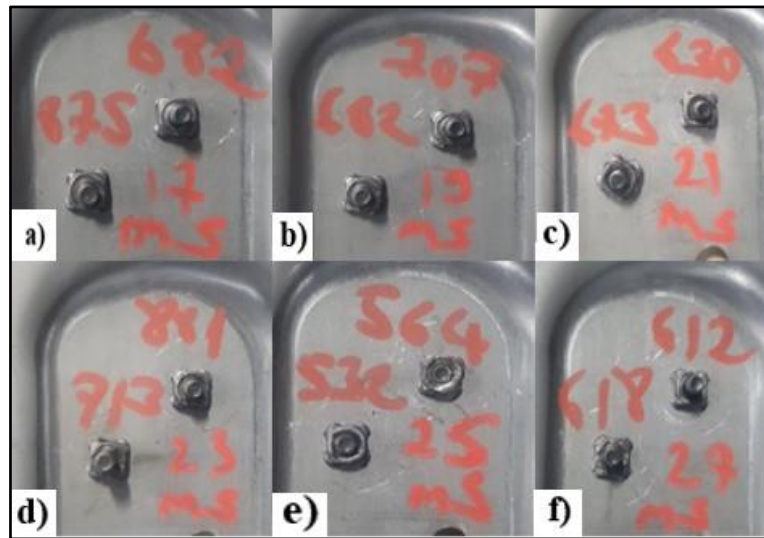

Figure 10. Images of pull-through tested specimens produced at different welding time: a) 17 ms, b) 19 ms, c) 21 ms, d) 23 ms, e) 25 ms and 27 ms

After the weld nut projection welding operation was performed on the prepared test piece, a full destructive pull-through tensile test was performed and the test results are given in Table 10. Figure 9 shows the graphical representation of the full destructive tear-out test results of projection welding of nuts before and after pull-through (fracture) tests (Figure 10). As seen in Table 11, the average fracture load value at the lowest welding time of 17 ms was found to be 778.2 daN, the average fracture load value at the 27 ms welding time was 615 daN, and the average fracture load value at the 23 ms welding time was found to be 797 daN. When associated with welding time, it was observed that the average pull-through load values were very much affected by the weld time. The welding time is important parameter in projection welding as it affects the heat input by allowing longer weld current application and hence increases the heat input occurring at the projections.

### 3.1.2. Results of electrode clamping force spot projection weld

The testing was carried out by increasing the electrode clamping force by 20daN for each test piece. Two weld nuts were projection welded to the samples prepared from WSS-M1A365-A22 steel sheets. Fully destructive sample test results are shown in Table 12. The results of the rupture load forces were compared as a result of the full destructive test after weld nut projection welding.

**Table 12.** Average pull-through load values for M4 DIN 928 weld nut for different weld clamping force (Standard deviations are given in brackets)

Specimen No	Clamping force (daN)	Average pull-through force (daN)
1	420	947.5 (±77.17)
2	440	847.5 (±63.43)
3	460	944.5 (±83.62)
4	480	883.5 (±76.90)
5	500	756 (±38.51)
6	520	534 (±32.27)

The test results of the fully destructive tear-off test by performing the weld nut projection spot weld operation on the prepared 6 test pieces is shown in Table 12. The average pull-through load value was found to be 947.5 daN at the lowest electrode compression force of 420 daN, the average pull-through load value was found to be 534 daN at the highest electrode compression force of 520 daN. The electrode compression force is known to ease the deformation at the stage where the temperature of the joint is high and hence it was observed that the average pull-through/fracture load values were affected by the electrode compression force. This is also affected by the deformation capacity of weld zone that are shortly deformable due to high temperature.

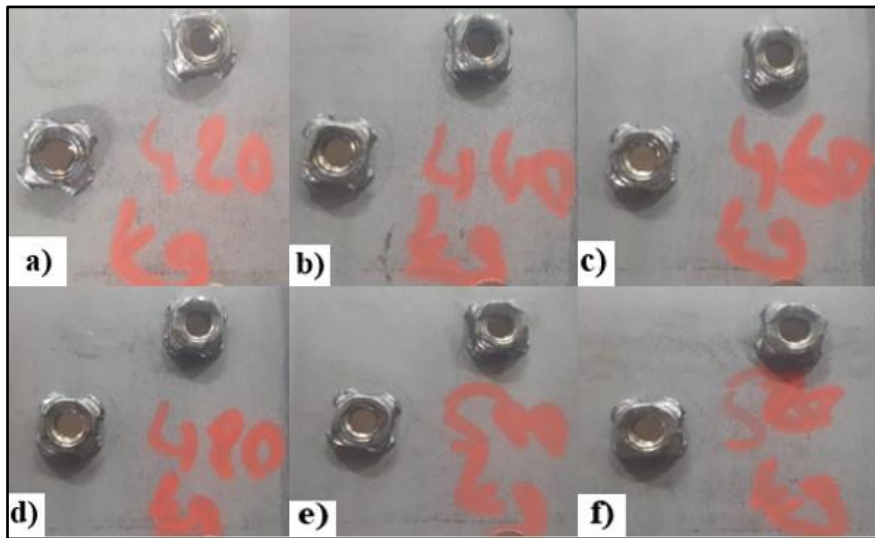

Figure 11. Pull-through test samples representation of M10x1.5 welding nut test samples projection welded at different clamping forces: a) 420 daN, b) 440 daN, c) 460 daN, d) 480 daN, 500 daN and 530 daN

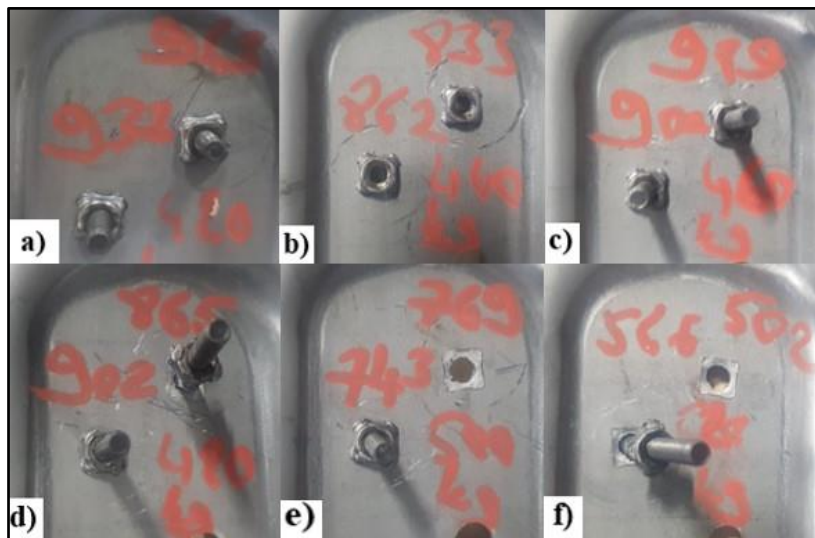

Figure 12. Images of pull-through tested specimens produced at different welding time: a) 420 daN, b) 440 daN, c) 460 daN, d) 480 daN, 500 daN and 530 daN

For the following images from the cross section of weld that were considered as successful and unsuccessful are given in Figure 13. The Figure 13a shows that successful joints formed an alloyed zone that is very close to the substrate where porosity is of no concern. Figure 13b shows weld zone with many defects such as porosity and delamination. These defects are sourced from the heat that was created from the high voltage and high current passage during the current firing process and highly deformed melted part. It is very clear that the strength of joint lies with the diminished resistance to the crack propagation starting from highly concentrated stress zones. As seen in Figure 13b that the net area of weld zone by which the joint is produced is very little or none at all. Hence, it is unsurprising that the low mechanical properties are observed with these kinds of joint. The stress produced on such joints is greater than that of applied load and pre-assumed stresses at the beginning of joining process.

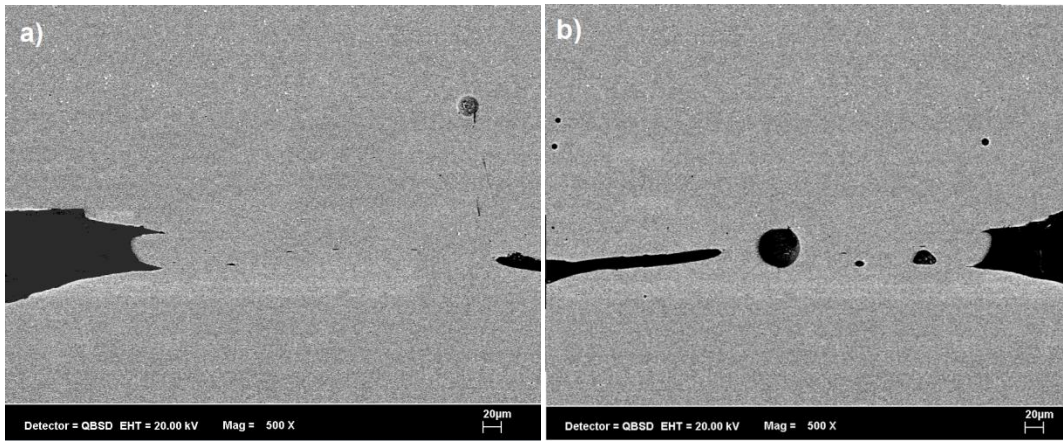

Figure 13. Successful and unsuccessful joint cross-sections of 23ms 18.5 kA series with a) 440 daN and b) 520 daN joints

### 3.2. Discussion of Overall Results (Genel Sonuçların Tartışması)

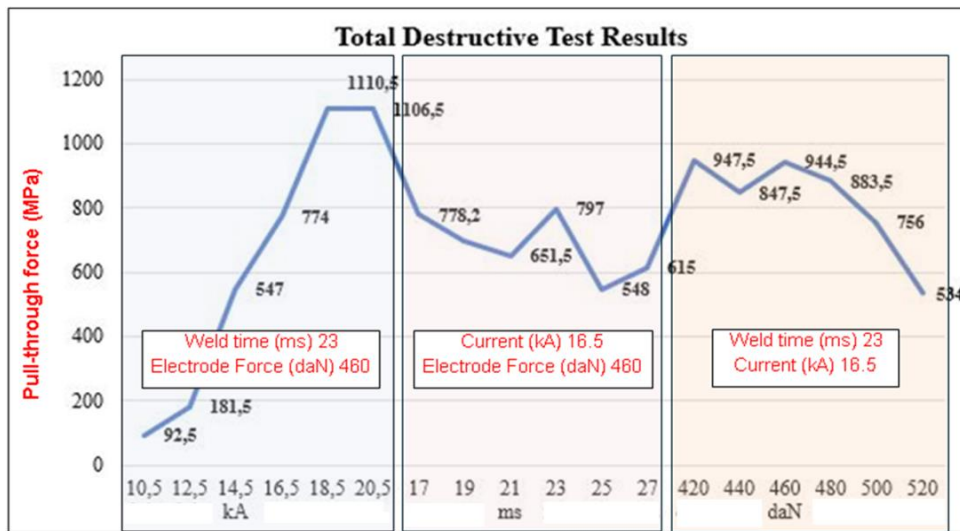

Figure 14. Inverse tensile pull-through force test values chart for M4 DIN 928 spot projection weld nut

Figure 14 shows the overall results from the reverse tensile or pull-through test of spot projection welded M4 DIN 928 nuts with respect to weld current, weld time and weld compression force. The results indicate that there are no significant shape changes in nuts and welded parts and the strength of welded joint increase with increasing current as opposed to welding time which declines with respect to increasing weld time. Similarly, lower compression forces also produce stronger joints compared with higher compression forces therefore; one can suggest that the compression force should be within 420-480 daN range. This may be emphasized for the fact that lower ranges of compression force and weld times are useful with high weld current. The mechanism by which the joint is effective in these ranges are because it can be articulated as the higher compression forces are not useful for the squeezing the liquid metal forming at the interface of nut and sheet metal. In this case, the compression force flattens the weld metal and increases the cross-sectional area for which higher current is needed to heat up the joint [14, 15, 20]. In addition, the high compression force ensures the formation of thin layer of liquidised joint which cools faster and the resultant weld joint structure may become harder than usual slowly cooled projection metal, this may result in a lower tensile pull-through test result. If it is assumed that weld pool is formed in equi-volume from both nut and sheet metal, the average C content would around 0.32 wt%, which one require a relatively fast cooling rate to form hard phases such as martensite. In addition, the formation of such phases would elevate the tensile strength, which is not the case when the results are considered. However, the thinning of (liquidised) weld zone due to high compression force poses another

important problem that is the weld volume may be reduced as the average temperature can be assumed would be lower and hence the melting of sheet metal becomes difficult, resulting in a lower strength with reduced amount of actual weld metal cross-section. The addition of longer heating duration through increasing weld time has also the same effect with increasing compression force as it helps the nut projections melt at higher temperature [16]. As the heat input is higher due to longer duration of current passing; this causes the formation of thinner projection weld joint which, in turn, produces lower tensile strength either due to the thickness imbalance as a result of either softer low strength weld joint or insufficient cross-sectional area due to splatter or shrinkage cavities [20,21]. Two of the parameters, that is, the weld time and compression force with constant weld current have little evident effect on the volume of molten metal between the nut and sheet metal as much as the tensile strength is concerned; however, the current has evidently dominant effect on the same incident to produce a better joint strength by melting the projection efficiently. This is why, the effect of current is more apparent as shown by the increase of strength of the projection spot weld joints. It is important to consider the effect of microstructure on the strength however the scope of this study was to determine the practical parameters and hence the microstructural analysis would be potential for further research.

In general, it can be concluded that, with increasing current values, heat formation at the interface of dissimilar steels is facilitated and subsequently a larger volume of metallic material is melted. In addition, the disadvantage of the short process time is that it loses the effect with increasing weld current values. If the weld heat input is low due to low current, this disadvantage will manifest itself as insufficient melting volume and insufficient strength to provide the weld strength [22]. However, with increasing weld heat input, the melting of nut projections becomes easier and at the same time the cooling rate decreases or the cooling time is prolonged, which will cause the molten projections to be sufficiently thick and coarse [15, 17]. Another reason for the increase in strength is that the pressure used effectively reduces the current passage distance over the melted volume and provides more current density at the beginning of process. Increased current and constant pressure positively affected the strength values of the joints. Similarly, in other studies [11, 16, 22], it has been revealed that increasing welding current causes an increase in the strength of the joint and the stability in strength values is observed after a certain current value for which the cross section of the joint is usually the determining factor.

#### 4. CONCLUSIONS (SONUÇLAR)

In this study, the weldability of low carbon steel similar to SAE1010 containing 0.3 wt% Ti and 0.2 wt.% Cu and medium carbon M4 nut welded by projection welding was studied from mechanical properties point of view. The following conclusions can be drawn from this study:

- It was observed that 14.5 kA weld current was sufficient enough for welding M4 DIN 928 weld nut by using projection welding onto 1.5 mm thick WSS-M1A365-A22 steel sheet.
- The welding time of 23 ms was found to be the most effective for strong spot projection welding however, the weld time should be adjusted to be between 17-23 ms for better adjustment.
- 460 daN electrode pressure force value M4 nut spot projection welding was sufficient for a successful welding. Excess of compression force do not improve the weld performance from the mechanical properties of view.
- 420 daN compression force also produced a sufficient pull-through fracture test results however, low compression forces may initiate the early failure due to insufficient formation of weld cross section. It is safer to apply slightly higher compression force than 420 daN.
- It is noted that the mechanical properties of dissimilar steel of AHSS and medium carbon 0.55 wt% steel can be successfully joined by projection welding and the weld appears to be sufficiently within the limits of required by the consumer.
- The mechanical test values showed that there is a need for further investigation especially on the microstructural effect of projection welding as both steels contains different amounts of C, Ti and Cu.



## ACKNOWLEDGMENTS (TEŞEKKÜR)

Scholarship in this study was supported by TÜBİTAK BİDEB (Turkish Scientific and Technological Research Council, Scientist Support Department) (Project No: 119C053).

## REFERENCES (KAYNAKLAR)

1. G. P. Chirinda, S. Matope, The lighter the better: weight reduction in the automotive industry and its impact on fuel consumption and climate change, Proceedings of the 2nd African International Conference on Industrial Engineering and Operations Management, Zimbabwe, 7-10 December, 2020.
2. A. Chebolu, Automotive lightweighting: a brief outline, In: A. Singh, N. Sharma, R. Agarwal, A. Agarwal, (eds), Advanced Combustion Techniques and Engine Technologies for the Automotive Sector. Energy, Environment, and Sustainability, Springer, Singapore, 2020.
3. G. Fontaras, N. G. Zacharof, B. Ciuffo, Fuel consumption and CO<sub>2</sub> emissions from passenger cars in Europe – Laboratory versus real-world emissions, Progress in Energy and Combustion Science, 60: 97-131, 2017.
4. A. G. Toroslu, Compensation of springback for high strength steels by thickness reduction method, Journal of Polytechnic, 25(3): 1359-1368, 2022.
5. H. Oikawa, G. Murayama, T. Sakiyama, Y. Takahashi, and T. Ishikawa, Resistance spot weldability of high strength steel (HSS) sheets for Automobile, Nippon Steel Technical Report, 95(385): 39-45, 2006.
6. A. Gürsoy Özcan, V. Peşteli, O. Yöntem, Optimization of resistance spot welded on high strength steels with Taguchi method, Uludağ University Journal of The Faculty of Engineering, 23(2): 333-350, 2018.
7. H. Ada, C. Çetinkaya, A. Durgutlu, Radiographic and macrographic investigations of welding parameters determined by Taguchi method in API 5L X65 pipe joints, Journal of Polytechnic, 22(2): 375-384, 2019.
8. Y. Kaya, and N. Kahraman, The effect of welding parameters on weld nugget formation in titanium sheets at resistance spot welding, Journal of Polytechnic, 14(4): 263-270, 2011.
9. R. Ertan, Ö. Mutlusu, Investigation of the welding capability of aluminum and titanium alloy sheets with IF steel sheets by resistance spot welding method, Journal of Polytechnic, 23(4): 1003-1013, 2020.
10. X. Wang, Y. Zhang, Effects of welding procedures on resistance projection welding of nuts to sheets, ISIJ International, 57(12): 2194-2200, 2017.
11. H. Kır, M. Yazar, Ş. Talaş, Investigation on the effect of projection types on stud weld strength by Taguchi method, Journal of Polytechnic, 1-1, 2023.
12. S. Ramasamy, J. Gould, D. Workman, Design of experiments study to examine the effect of polarity on stud welding, Welding Journal, 81(2): 19-26, 2002.
13. S. Ha, S. P. Murugan, K. P. Marimuthu, Y. Park, H. Lee, Estimation of lobe curve with material strength in resistance projection welding, Journal of Materials Processing Technology, 263: 101-111, 2019.
14. H. Tang, W. Hou, S. Hu, Forging force in resistance spot welding, Proceedings of the Institution of Mechanical Engineers, Part B: Journal of Engineering Manufacture, 216(7): 957-968, 2002.
15. C. V. Nielsen, W. Zhang, P. A. F. Martins, N. Bay, 3D numerical simulation of projection welding of square nuts to sheets, Journal of Materials Processing Technology, 215: 171–180, 2015.
16. E. Tolf, J. Hedegård, Resistance nut welding, Weldability to ultra-high strength steels and joint properties 59th Annual Assembly of IIW (International Institute of Welding), Quebec, Canada, 2006.
17. Z. Mikno, Projection welding of nuts involving the use of electromechanical and pneumatic electrode force, The International Journal of Advanced Manufacturing Technology, 99: 1405–1425, 2018.
18. S.C.A. Alfaro, J.E. Vargas, M.A. Wolff, L.O. Vilarinho, Comparison between AC and MF-DC resistance spot welding by using high speed filming, Journal of Achievements in Materials and Manufacturing Engineering, 24(1): 333-339, 2007.
19. Albaksan product catalogue, Albaksan Teknoloji Co., Bursa, 2022.
20. J.W. Ringsberg, P. Orvegren, H.F. Henrysson, G. Åkerström, Sheet metal fatigue near nuts welded to thin sheet structures, International Journal of Fatigue, 30(5): 877–887, 2008.
21. P. Sejš, J. Belanová, Z. Gábrišová, B. Vanko, The influence of parameters of the resistance projection welding of M10 steel nuts to the galvanized steel sheet DP 600 on selected joint characteristics, Manufacturing Technology, 20 (6): 822-833, 2020.
22. M. Jou, Experimental investigation of resistance spot welding for sheet metals used in automotive industry, JSME International Journal, Series C, 44(2): 544-552, 2001.