



Impact of Uncertainties of Nuclear Severe Accidents on Radiological and Nuclear Dispersion Predictions

Ciddi Nükleer Kazalardaki Belirsizliklerin Radyolojik ve Nükleer Dağılım Tahminlerine Etkisi

Ahmet Kağan Mercan[✉]

Department of Nuclear Engineering, Hacettepe University, Ankara, Turkey.

ABSTRACT

Protection of the public as well as the environment is primal task of the regulators and provisions to sustain integrity of the plant have been developed. In addition to that, the consequences of possible severe accidents are necessary to develop strategies to mitigate the impact. Evaluation by using severe accident tools is common practice accepted by regulators, but these tools rely on models that generated by using limited experimental data. Thus, reliable evaluation of the accident also requires uncertainty quantification of the results. In this work, selected accident case on VVER-1000 is performed by using ASTEC tool and the uncertainties of the ASTEC code is quantified by using KATUSA tool with the goal of determination of the potential impact range. 100 samples are generated according to selected uncertain parameters, their probabilistic distribution functions (PDFs) and variation range, and multiple ASTEC code simulations are performed to evaluate the results. Finally, JRODOS calculation is performed on Zaporizhzhia NPP with worst-case and best-estimate scenarios to identify the difference on the radiological impact. The potential difference on the inventories results with almost two times higher radiological contamination of the selected area on selected period which causes almost 1.5 times higher doses on the population.

Key Words

CBRN, KATUSA, ASTEC, JRODOS, uncertainty quantification.

ÖZ

Halkın ve çevrenin korunması, düzenleyicilerin temel görevidir ve tesisin bütünlüğünü sürdürmek için önlemler geliştirilmiştir. Buna ek olarak, olası ciddi kazaların sonuçlarına karşı etkileri hafifletmek için stratejiler geliştirmek gerekir. Ciddi kaza yazılımları kullanılarak değerlendirme, düzenleyiciler tarafından kabul edilen yaygın bir uygulamadır, ancak bu araçlar sınırlı deneysel veriler kullanılarak oluşturulan modellere dayanır. Dolayısıyla, kaza için güvenilir bir değerlendirme, sonuçların belirsizliklerinin nicelendirilmesini de gerektirir. Bu çalışmada, VVER-1000 üzerinde seçilmiş bir kaza durumu ASTEC aracılığıyla gerçekleştirilmiş ve ASTEC kodunun belirsizlikleri, potansiyel etki aralığının belirlenmesi amacıyla KATUSA aracılığıyla nicelendirilmiştir. Seçilen belirsiz parametrelere göre 100 örnek oluşturulmuş, bunların olasılık dağılım fonksiyonları (PDF'ler) ve değişim aralıkları belirlenmiş ve sonuçları değerlendirmek için birden fazla ASTEC kod simülasyonu gerçekleştirilmiştir. Son olarak, Zaporizhzhia NGS'de en kötü senaryo ve en iyi tahmin senaryolarıyla JRODOS hesaplaması yapılarak, seçilen bölgedeki radyolojik etki farkı belirlenmiştir. Sonuçlar, seçilen dönemde seçilen alanın neredeyse iki kat daha yüksek radyolojik kirliliğine maruz kaldığını ve nüfusa neredeyse 1.5 kat daha yüksek dozun ulaştığını göstermektedir.

Anahtar Kelimeler

KBRN, KATUSA, ASTEC, JRODOS, belirsizliklerin nicelendirilmesi.

Article History: Received: Oct 21, 2024; Accepted: Nov 27, 2024; Available Online: Dec 9, 2024.

DOI: <https://doi.org/10.15671/hjbc.1571208>

Correspondence to: A.K. Mercan, Department of Nuclear Engineering, Hacettepe University, Ankara, Turkey.

E-Mail: kaganmercan@hacettepe.edu.tr

INTRODUCTION

Fukushima Daiichi NPP accident triggered many efforts on the determination of the possible outcomes of a severe accident, progression of the severe accidents and radiological consequences of the severe accidents worldwide [1] [2]. Realistically estimating the impact of radiological and nuclear emissions under the CBRN concept requires burn-up analyses, severe accident simulations and radiological impact analyses to be performed together, as well as estimating the variable results of the analyses as a result of quantifying the uncertainties.

To able to achieve this, simulation of the severe accidents on tools such as ASTEC [3],ATHLET-CD [4] and MELCOR [5] is commonly used, and JRODOS [6] and PAVAN [7] kind of radiological dispersion and consequence analysis codes are applied on prediction of radiological hazard of potential source term (ST). Although the accident progression learned from previous nuclear accidents and limited experiments [8] performed on severe accidents provide important mathematical and empirical models, the models developed based on them contain margins of error. Therefore, estimating uncertainties and determining their potential impact on the results, as well as determining the course of the accident, provides emergency planning and emergency response teams with the opportunity to intervene effectively before and after the accident.

This study investigates the possible influence of uncertainty on radiological consequences in the event of a severe accident on VVER-1000. In the ASTEC model of the VVER-1000, uncertainties that could impact ST transport, release, and leakage to the containment and environment are identified for this analysis. Uncertainty analysis is then performed using the in-house KATUSA tool [9].ASTEC is a widely used IRSN tools to predict the progression of serious accidents and the transport and leakage of fission products. KATUSA, on the other hand, was created in KIT to simulate many calculations using various created samples in order to predict simple statistics, result uncertainty, and sensitivity analysis. The effect of this difference on the radiological dispersion is simulated using JRODOS in the Zaporizhzhia NPP region, and differences in contamination, dose values, and activity concentrations are estimated after identifying the

uncertainties and computing the maximum and average values for the leaked radiological ST. Additionally, KIT created JRODOS [6] to predict radiological repercussions and the effect of emergency preparedness efforts, as well as to simulate radiological dispersion from a location.

By this approach, ASTEC-KATUSA-JRODOS platform can identify range of risk of a potential severe accident to support emergency preparedness efforts and planning as well as potential difference on accident progression.

DEVELOPMENT OF ASTEC MODEL OF VVER-1000

An ASTEC model of VVER-1000 was developed under CESAM project [10] and the existing model is enhanced by modelling of newer containment structure and containment accident model to simulate ex-vessel accident progression [11]. The initial radiological fission product (FP) inventory is generated by in-house KORIGEN tool for 42 GWd/t heavy metal uranium. A Large Break Loss of Coolant Accident (LBLOCA) is modelled between downcomer and the main coolant pump. Also, Station Blackout (SBO) is considered to simulate severe accident. The developed VVER-1000 ASTEC core, primary and secondary circuit as well as the location of the break are depicted in Figure 1. The vessel is divided into seven volumes to represent accurate flow channels and lower plenum is modelled with its inner structures like lower plenum support plate and 163 lower plenum support columns. Horizontal steam generators specific to VVER type reactors detailly modelled in order to represent accurate heat transfer between primary circuit to the secondary circuit. Between steam generator hot and cold collectors, steam generator tubes are modelled as three axial and six horizontal volumes. In addition, cold leg is separated into three volumes according to their axial elevation. The active safety systems of high-pressure injection system (HPIS), low pressure injection system (LPIS) and auxiliary safety pumps as well as relief valves on pressurizer and steam generators are considered to be able to describe accident progression accurately. Also, passive accumulators are modelled to inject water to the upper plenum and downcomer. In addition, passive relief valves on pressurizer and steam generators are considered in case of blackout scenarios. The initial conditions for the simulations are listed in Table 1.

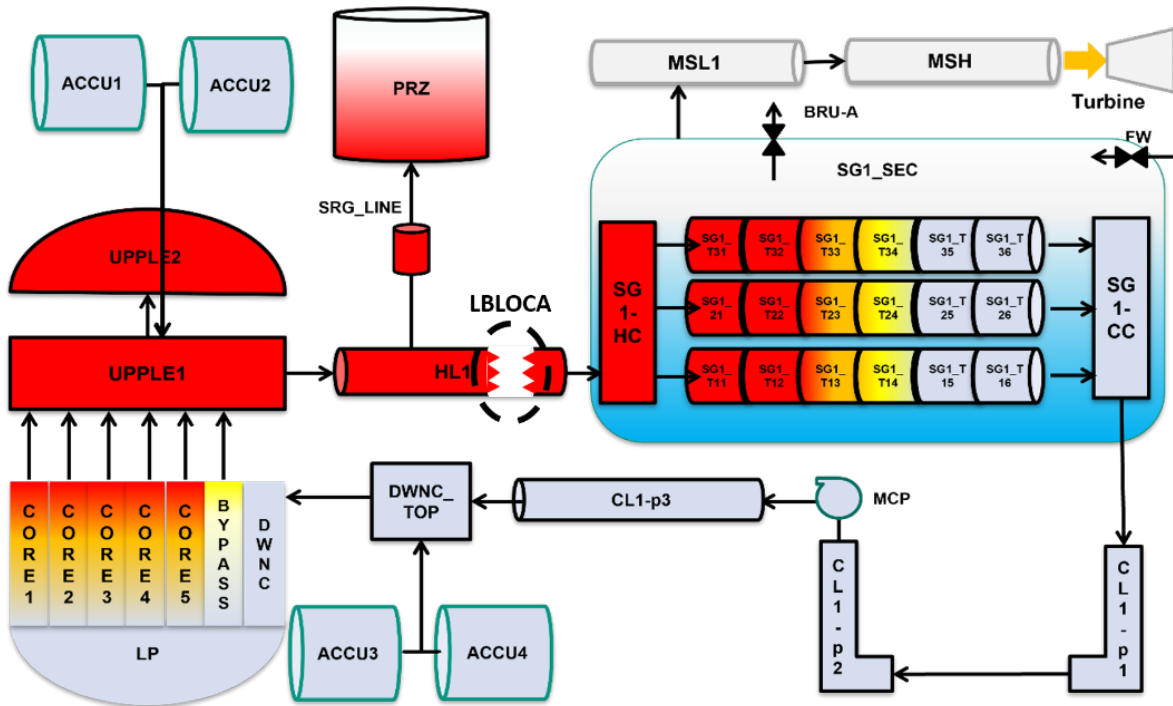

Figure 1. The sketch of ASTEC VVER-1000 vessel, primary and secondary circuits and break location modified from [11].

Table 1. List of key plant parameters and comparison of ASTEC predictions with reference data taken from [12].

Name of the Parameter	Unit	Reference [12]	ASTEC
Core power	MW	3000	3000
Lower plenum pressure	MPa	15.842	15.83
Pressure above the core	MPa	15.70	15.67
Core inlet temperature (Loop 1)	K	560.15	561.78
Core inlet temperature (Loop 2)	K	560.15	561.78
Core exit temperature (Loop 1)	K	592.05	592.11
Core exit temperature (Loop 2)	K	592.05	592.11
Core inlet mass flow rate (Loop 1)	kg/s	4400	4400
Core inlet mass flow rate (Loop 1)	kg/s	13200	13200
SG exit pressure (Loop 1)	MPa	6.27	6.27
SG exit pressure (Loop 2)	MPa	6.27	6.27
SG exit temperature (Loop 1)	K	551.65	551.32
SG exit temperature (Loop 2)	K	551.65	551.32
Feedwater flow	kg/s	409	409
Feedwater temperature	K	493.15	493.15
SG water level (Loop 1)	m	2.55	2.55
SG water level (Loop 1)	m	2.55	2.55
SG water level (Loop 1)	m	2.55	2.55

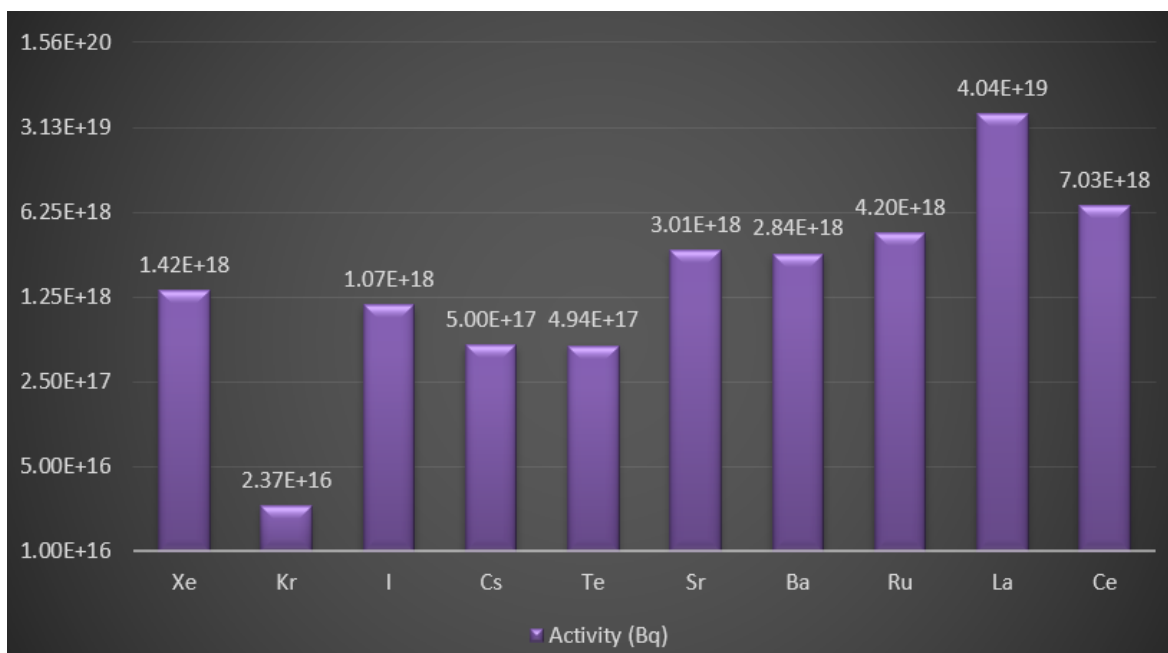

Figure 2. The calculated main FPs' inventories for 1-ton heavy metal (HM) by using KORIGEN burn-up tool modified from [11].

For the calculation of LBLOCA case on ASTEC, all in-vessel and ex-vessel modules are activated as well as FP transport and retention models to investigate release to the environment. The severe accident calculation is performed until the rupture of the cavity. For the accident scenario, the break is opened at 0 s. together with reactor scram and pump coast. Following these events, turbine trip is given about 1.6 s. and closing of feed-water flow at 5 s. The passive hydro accumulators are considered and they will be activated when the system pressure is below than 5.9 MPa. The leakage between containment and the environment is modelled through flow area.

Finally, burn-up calculation by using KORIGEN tool is performed to realistically estimate initial fission product inventory at the beginning of the accident. For realistic approach, the accurate description of the core FP inventory and status of the core at the beginning of the transient is crucial [13]. The Figure 2 shows the calculated inventory of critical FPs at the beginning of the transient for 1-ton fuel. In CBRN, these selected elements are significant on external and internal dosimetry. The total activity at the beginning is about 3.21×10^{20} Bq.

UNCERTAINTY QUANTIFICATION (QU) WITH KATUSA TOOL

KATUSA tool is developed by KIT to quantify uncertainties of ASTEC code and to determine the most impactful parameter among selected uncertain parameters, and impact rate of the parameters to the monitored results. To do this, KATUSA creates samples based on random sampling, Latin Hypercube Sampling (LHS) [14] or Monte-Carlo [15] sampling within uncertain parameters by using their probability density functions (PDFs), variation range and reference values. The KATUSA code allows ASTEC to calculate in parallel by preparing data entry sets equal to the number of samples created. After all the results acquired, simple statistics calculation and best-estimate results as well as maximum, minimum, mean, 5th and 50th percentile results are calculated for selected Figure-of-Merits (FOMs). Finally, KATUSA can calculate effect of each given uncertain parameter to the selected FOM.

In this calculation, a list of uncertain input parameters to be sampled is provided, together with the probability density functions (PDFs) and parameters of each PDF, in order to conduct the uncertainty analysis. The selected parameters as well as their PDFs based on engineering judgment and literature [9] [16] is shared in Table 2. The

Table 2. Selected parameters effective on ST release, transport and leakage.

Parameter	Phenomena	Description	Reference Value	Variation Range	PDF
frho		Particle best-estimate density (kg/m ³)	3000.	Min=2400. Max=3600.	Uniform
fspheat		Particle best-estimate specific heat (J/kg K)	840.	Min=672. Max=1008.	Uniform
fR_min	Aerosol size, shape and thermal properties	Particle minimum radius (m)	1.0E-08	Min=1.E-09 Max=2E-08 Mode=1.1E-08	Triangular
fR_max		Particle maximum radius (m)	2.0E-5	Min=5.E-06 Max=2E-05 Mode=1.99E-05	Triangular
fv_stks		Shape factor relative to Stokes velocity	1.0	Alpha=1.0 Beta=5.0 Min=1.0 Max=3.0	Beta
fTBEG	Gas generation	Temperature of oxidation begins (K)	600.	Min=480. Max=1008.	Uniform
fTABLA		Ablation temperature at cavity (K)	1570.	Min=1256. Max=1884.	Uniform
f_leak	Leakage to the environment	Containment leakage area (m ²)	3.14E-02	Min=3.14E-02 Max=3.14E-01	Uniform

activity released to the containment and to the environment are selected as FOMs

The primary purpose of the investigation on aerosol size, shape, and thermal properties is to observe how the ASTEC handled FP transport and release during a transient. Particle minimum radius (fR_min) and particle maximum radius (fR_max) change the aerosol particle dimensions, whilst particle best-estimate density (frho) and particle best-estimate specific heat (fspheat) might affect the heat transfer between aerosol and the walls of the primary circuit and the containment. The aerosols' gravitational effect is significantly influenced by their shape factor in relation to Stokes velocity (fv_stks). Furthermore, studies have been done on the leakage region (f_leak) from the confinement to the environment. Since hydrogen is one of the carriers of the FPs during the transient, the effects of the onset tempera-

tures of the oxidation (fTBEG) and ablation in the cavity (fTABLA) are also examined.

In order to quantify the selected uncertainties, 100 samples are created with Latin Hypercube Sampling (LHS) method and 100 ASTEC simulation is simulated parallelly. 6 parallel runs are not converged which they are not considered in the calculation. According to the selected Figure-of-Merits (FOMs), the 94 simulation results are used to calculate simple statistics.

RESULTS and DISCUSSION

The maximum and minimum timing of the key events of a severe accident progression are shown in Table 3. The difference on the estimation of when the FPs start to release from the fuels is about 0.5 min. Lower head is estimated to fail between the times of 6.2 h and 11.1 h. Finally, more than 16-hour difference is observed on

Table 3. The range of the key events occurring during LBLOCA on hot leg with SBO in VVER-1000.

Event	Minimum Time	Maximum Time
Start of FP release from the fuels	26 min	26.5 min
Total uncover of the core	1.6 h	2.1 h
Lower head vessel failure	6.2	11.1 h
Rupture of the cavity	24	40.3

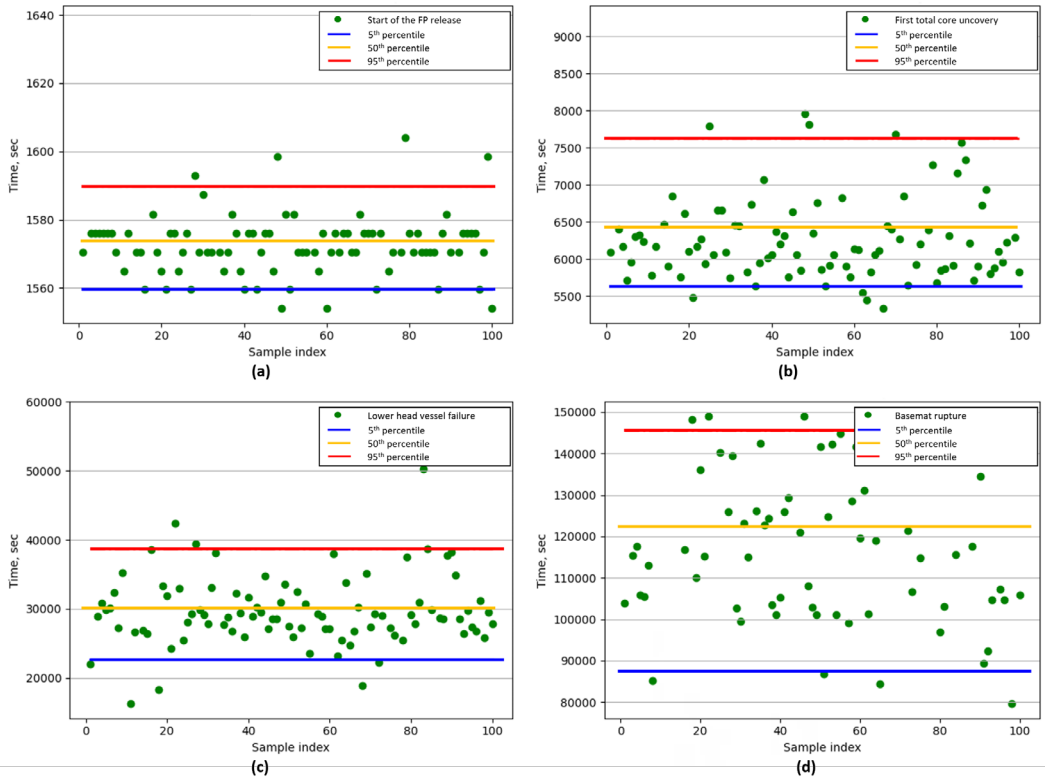

Figure 3. Most probable time window for fission product release (a), uncover of the core (b), lower plenum failure (c) and rupture of the basemat (d)

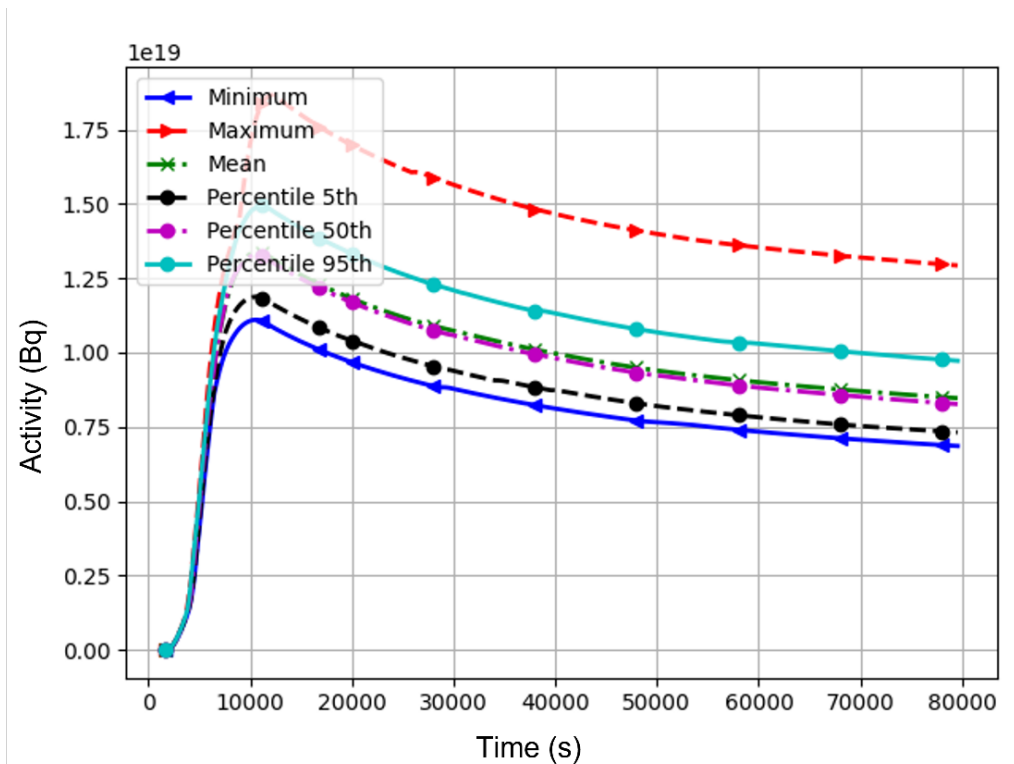

Figure 4. Calculated range of released activity to the environment at the end of severe accident case.

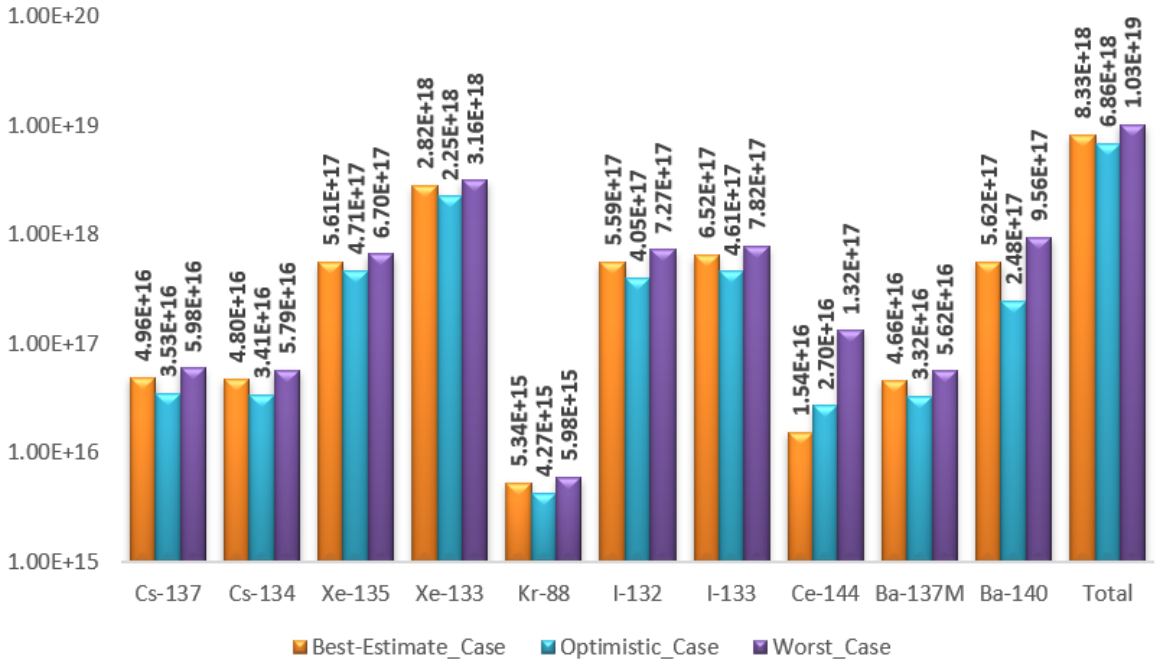

Figure 5. Calculated maximum, best-estimate and optimistic isotope-wise activity at the end of ASTEC simulation.

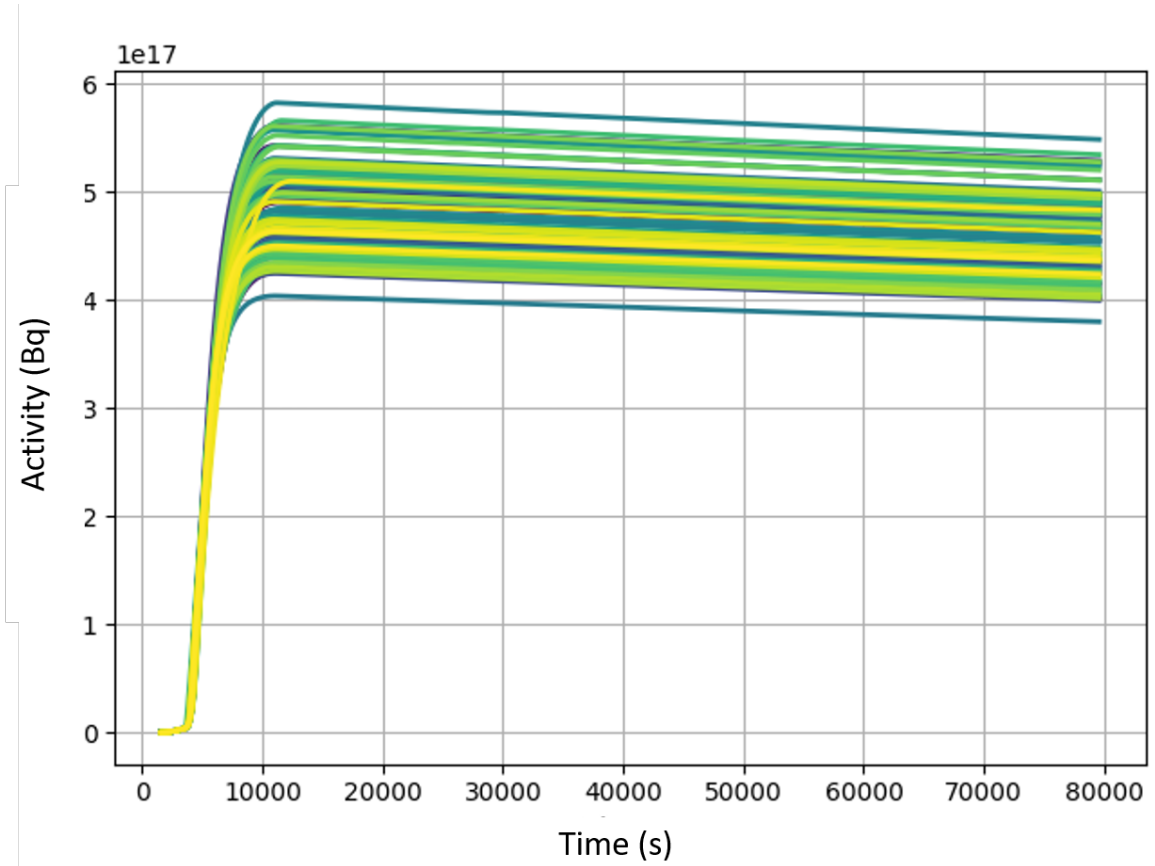

Figure 6. Calculated range of I-131 activity released to the environment at the end of ASTEC simulation.

the rupture of the cavity which leads the contamination of the soil.

Figure 3 shows most probable time windows for key events seen during severe accident progression. Information on not only best-possible time of an event but also range of times is crucial for generation of effective emergency preparedness plans and well-preparing of early emergency intervention teams in such radiological and nuclear events. The time window for lower head failure indicates that the lower head, second barrier between radioactive molten material and the environment, could be penetrated around 39000 s with 95 percent probability. Severe accident management (SAM) applications for keeping integrity of lower plenum could be planned by regulators with such information.

As Figure-of-Merit (FOM), the total activity released to the containment and to the environment are selected

and maximum, best-estimate, minimum values for the estimation of activity discharge to the environment is calculated as well as 5th percentile, 50th percentile and 95th percentile. The Figure 4 demonstrates the range of total isotope activity released to the environment as a result of LBLOCA on the hot leg along with SBO accident. The activity result would be $0.97E19$ Bq with 95 probability but the maximum results within 100 samples is about $1.03E19$ Bq. On the other hand, the mean of the results reaches approximately $0.83E19$ Bq and minimum of the results is under $0.70E18$ Bq at the end of calculation. The difference on predictions of maximum and mean released activity is approximately $0.20E19$ Bq and the main difference comes from the release of volatile radioactive isotopes such as I-131, I-132, I-133, Cs-134, Cs-137, Ba-137M, Te-132, Sr-90, Ce-144 which can be seen in Figure 5. Therefore, the emergency requirement, planning and cost would be different to maintain safety of the surrounding region and impacted zone

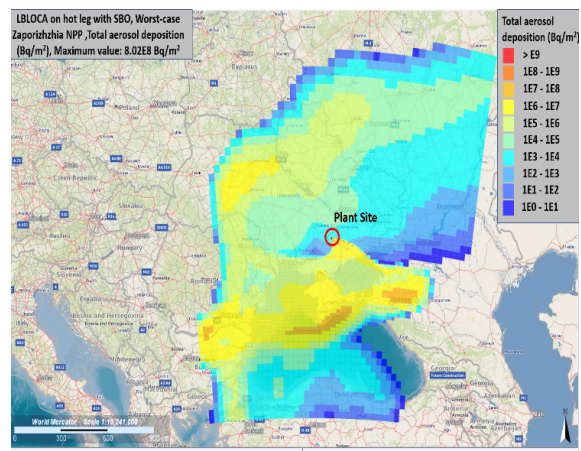
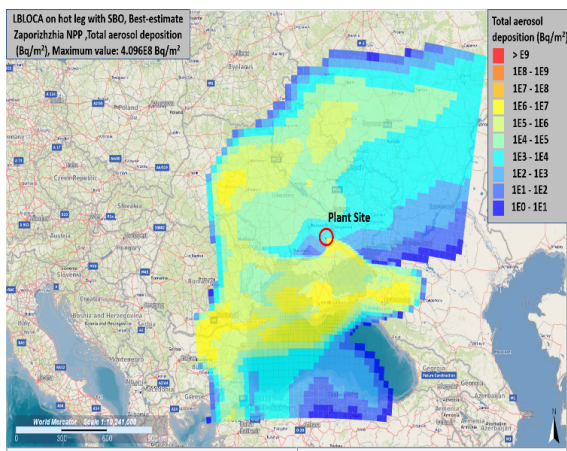

Figure 7. Computed aerosol deposition by using JRODOS in Zaporizhzhia NPP with best-estimate (left) and worst-case (right) release predictions at the end of 10-day dispersion.

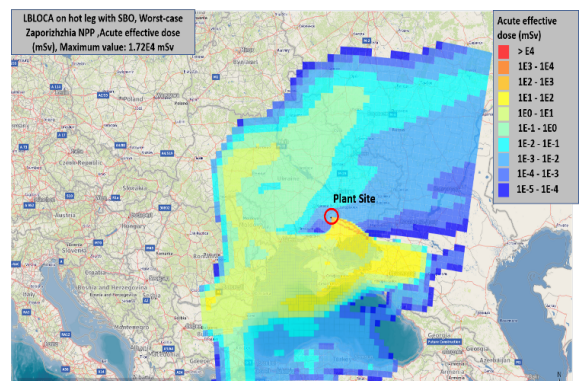
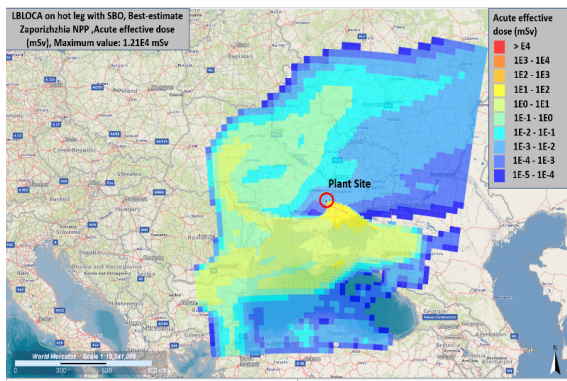

Figure 8. Computed acute effective dose by using JRODOS in Zaporizhzhia NPP with best-estimate (left) and worst-case (right) release predictions at the end of 10-day dispersion.

along dispersion range.

The difference on released activity would create different environmental impact. Figure 6 demonstrates the calculated I-131 release to the environment results of uncertainty quantification. International Nuclear and Radiological Event Scale (INES) estimates the severity of an accident and the I-131 activity is used for calculating INES of an accident [17]. According to the UQ of the accident, the LBLOCA on the hot leg along with SBO results change between 7.11 to 6.88 in INES scaling.

In fact, JRODOS simulation is performed on Zaporizhzhia NPP with meteorological information with best-estimate results and worst-case scenario to be able to estimate radiological impact difference. Figure 7 shows the contamination distribution at the end of 10-day dispersion with best-estimate and worst-case estimations on the release due to LBLOCA on hot leg along with SBO. Following Figure 8 demonstrates the acute effective dose with best-estimate and worst-case scenarios. While the maximum aerosol deposition is 4.09×10^8 Bq/m² for best-estimate case, this value reaches about 8×10^8 Bq/m² with the worst-case estimation. This nearly two-fold difference causes the dose difference to reach 0.5×10^4 mSv for the maximum value. Approximately 6 million people would encounter effective doses over 1 mSv in worst-case scenario, however, best-estimate scenario results with 2.1 million people over 1 mSv. Difference on released source term due to uncertainty would result with more areas to evacuate, more people to relocate and more supplement of stable iodine pill. The results show requirement of different emergency planning for same accident scenario because of uncertainties that affects severe accident progression estimations.

SUMMARY

In this study, uncertainty quantification is performed on a hypothetical severe accident scenario to be able to determine effect on radiological impact results. In CBRN predictions, accurate radiological source term inventory estimations as well as uncertainty band on the released activity is essential information to support regulators, emergency preparedness planning organizations and emergency intervention teams to mitigate radiological impact to the population effectively and efficiently.

The results of the work show that between worst-case scenario and best-estimate case, the difference of approximately 4×10^8 Bq/m² can result with 5×10^3 mSv difference for same geography and same meteorological conditions. This situation surely requires additional resource, manpower and cost in emergency applications which should be planned beforehand by regulators and emergency preparedness teams. Therefore, radiological impact estimations should cover uncertainty quantification.

For the future work, sensitivity analyses can be considered for these calculations to determine the most sensitive data on radiological impact estimation. Thus, research on accurate definition for this sensitive data can be undertaken for realistic results.

References

1. NEA-OECD, "The Fukushima Daiichi Nuclear Power Plant Accident: Nuclear Safety," NEA Report No:7161, Paris, 2013.
2. D. Manara, D. Jacquemin, J. P. Van Dorsselaere, P. D. Bottomley, M. Adorni, C. Journeau, Y. Pontillon, T. Lind, L. E. Herranz, F. Rocchi, S. P., J. C. de la Rosa Blul, S. Bechta, J. Duspiva, I. Kljenak and P. Dejardin, "Severe Accident Research Priority Ranking: A New Assessment Eight Years After The Fukushima Daiichi Accident," in 9TH Conference on Severe Accident Research (ERMSAR 2019), Prague, 2018.
3. P. Chatelard, S. Belon, L. Bosland, O. Coindreau, F. Cousin, C. Marchetto, H. Nowack and L. Piar, "Focus on the main modelling features of ASTEC V2.1 major version," in 7th European Review Meeting on Severe Accident Research (ERMSAR2019), Marseille, 2015.
4. H. Austregesilo, P. Schöffel, D. Cron, F. Weyermann, A. Wielenberg and K. W. Wong, "ATHLET-CD 3.3 User's Manual," Gesellschaft für Anlagen- und Reaktorsicherheit (GRS) gGmbH, GRS-P-4/Vol. 2 Rev. 0., 2021.
5. L. Humphries, V. Figueroa, M. Young, D. Louie and J. Reynolds, "MELCOR Computer Code Manuals (No. SAND-2015-6692R)," Sandia National Lab. (SNL-NM), Albuquerque, NM (United States), 2015.
6. W. Raskob, D. Trybushnyi, I. Ievdin and M. Zheleznyak, "JRODOS: Platform for improved long term countermeasures modelling and management," Radioprotection, vol. 46, no. 6, pp. 731-736, 2012.
7. T. Bander, "an atmospheric dispersion program for evaluating design basis accidental releases of radioactive materials from nuclear power stations," Y 3.N 88:25/2858, Office of Nuclear Reactor Regulation, U.S. Nuclear Regulatory Commission, Washington, 1982.
8. P. Chatelard and L. Laborde., "Synthesis of the ASTEC V2.2 code validation vs. experimental," in the 10th European Review Meeting on Severe Accident Research (ERMSAR-2022), Karlsruhe, 2022.

9. Stakhanova, F. Gabrielli, V. P. E. Sanchez-Espinoza and A. Hoefler, "Uncertainty and Sensitivity Analysis of the ASTEC simulations results of a MBLOCA scenario at a Generic KONVOI Plant using FSTC tool," in The 10th European Review Meeting on Severe Accident Research (ERMSAR2022), (pp. 861-872). Karlsruhe: KITopen-ID: 1000151444, DOI: 10.5445/IR/1000151444., 2022.
10. L. Herranz, "ASTEC code development, validation and applications for severe accident management within the CESAM European project," in ICAPP, Nice, 2015.
11. K. Mercan, F. Gabrielli, V. H. Sanchez-Espinoza and W. Raskob, "Analysis of the consequences of a LBLOCA with SBO severe accident in a generic VVER-1000 by means of ASTEC and JRODOS codes," Nuclear Engineering and Design, no. Volume 400, p. 112078, 2022.
12. K. Ivanov, B. Ivanov, P. Groudec, M. Pavlova and V. Hadijev, "VVER-1000 Coolant Transient Benchmark-Phase 1 (V100OCT-1) Volume 1: Main Coolant Pump (MCP) switching on- Final Specifications," OECD Publishing, Paris, 2002.
13. F. Gabrielli, A. Stakhanova, V. Sanchez-Espinoza, E. Pauli, A. Hoefler and H. Feldmann, "Impact of Realistic Fuel Inventories on the Radiological Consequences of a Severe Accident Scenario in a Generic KONVOI Plant by means of the ASTEC code," in KERNTECHNIK, Leipzig, 2022.
14. R. L. Iman, J. C. Helton and J. E. Campbell, "An approach to sensitivity analysis of computer models, Part 1. Introduction, input variable selection and preliminary variable assessment," Journal of Quality Technology, vol. 13, no. 3, pp. 174-183, 1981.
15. W. K. Hastings, "Monte Carlo Sampling Methods Using Markov Chains and Their Applications," Biometrika, vol. 57, pp. 97-109, 1970.
16. K. Mercan, "Severe accident investigations for VVER-reactors including radiological impact and quantification of uncertainties," KIT, Karlsruhe, 2024.
17. International Atomic Energy Agency (IAEA), "INES Rating Information and User's Manual," Non-serial Publications, IAEA, Vienna, 1990.