



Received: 09.11.2017

Accepted: 19.05.2018

Editors-in-Chief: **Ebubekir ALTUNTAS**

Area Editor: **Ahmet FENERCİOĞLU/ Bilge GÖZENER**

Investigation of 3D Printing Occupancy Rates Effect on Mechanical Properties and Surface Roughness of PET-G Material Products

Ahmet İPEKÇİ^a, Menderes KAM^{b,*}, Hamit SARUHAN^c

^a Department of Machinery and Metal Technology, Dr. Engin PAK Cumayeri Vocational School, Düzce University, Turkey, ahmetipekci@duzce.edu.tr

^b Department of Machinery and Metal Technology, Dr. Engin PAK Cumayeri Vocational School, Düzce University, Turkey, mendereskam@duzce.edu.tr

^c Department of Mechanical Engineering, Faculty of Engineering, Düzce University, Turkey, hamitsaruhan@duzce.edu.tr

*Corresponding author

ABSTRACT: Recent developments in 3D printing are attracting wide spread interest due to easily accessible with lower cost. The present paper aims to investigate printing occupancy rates effect on mechanical properties and surface roughness of PET-G (Polietilen Tereftalat Glikol) material products. Pet-G material was preferred because of its malleability, colorability, and mechanical properties. Test samples from PET-G were printed at different printing occupancy rates (20%, 50% and 80%) at printing speed of 45 mm/s and all other operating parameters fixed at the same conditions on 3D printer. Uniaxial tensile tests, hardness measurements and surface roughness measurements of the printed samples were carried out. The results were analyzed and compared.

Keywords – 3D Printer, PET-G, Printing Occupancy Rate, FDM

1. Introduction

Three dimensional (3D) printers are computer aided manufacturing since they are faster than classical manufacturing methods, nowadays almost every industrial area such as automotive, aerospace, medical, education purpose use 3D printers. 3D printers commonly manufacture products using ABS (Akrilonitril Butadien Stiren), PLA (Polilaktik Asit), and PET-G (Polietilen Tereftalat Glikol) materials. Dimensions and surface of products are need to be manufactured precisely (Çelik, 2015 ; Levy at al. 1996 ; Ahrabi 2009).

Mechanical characteristics of 3D products materials must be known for proper manufacturing. PET-G is one of the most important engineering polymers because of its mechanical characteristic features (machinability, colorability etc). PET-G is better than other thermoplastics and it has strength, toughness, brightness, impact resistance, also its gas permeability is lower than most of others (Billiet at al. 2012; Ruffo at al. 2007).

Nowadays, 3D printers have been used widely in daily life and defense industry for prototyping and metal etching. Most of equipments used at house and office can be produced using 3D printers, instead of buying from markets. Also, children can design and produce their own toy using 3D Printers for education purpose. Today, some parts of warplanes also manufactured with 3D printers (Palousek at al. 2014; Singare at al. 2009; Kroll at al. 2011; Campbell at al. 2012).

Manufacturing processes are developing rapidly to do more sensitive products. Product amounts are increased according to increasing requirements (Stephens *et al.* 2013). Ratio of waste material in traditional production methods is very high. In 3D printing has no waste material left and also products that could not be manufactured by traditional methods or needs many processes can be manufactured by 3D printers at once (Günther 2014).

The studies about 3D printing systems include varied process parameters (Lee *et al.* 2007; Calvert, 1998), printing technics, reverse engineering practice [Fantini *et al.* 2008; Bernard 2012], observation of medical devices (Chimento *et al.* 2011), development of production area (Marchelli *et al.* 2011), different technics and their applications (Campbell *et al.* 2012; Piattoni *et al.* 2012; Kashedan *et al.* 2012; Vaezi *et al.* 2013; Qiu and Langrana 2002), medical, constructional, and aeronautic investigations (Birtchnell and Urry 2013; Polzin *et al.* 2013; Dale Prince, 2014; Paulic *et al.* 2014). Most conventional manufacturing method is Fused Deposition Method (FDM) by having plastic is melted. Melted material is drained through a moving head above bottom layer to manufacture solid objects (Pham and Gault 1997). Turner *et al.* studied the FDM and reported the principles of this process (Turner *et al.* 2014).

This study aimed to investigate the 3D printing occupancy rates effect on mechanical properties and surface roughness of PET-G material products. Tensile tests, hardness measurement, surface roughness measurement test are utilized to analyze and compare the results.

2. Material and Methods

For this experimental study, samples were manufactured for tensile test with the same printing speed (45 mm/s), extruder temperature (240 °C), table temperature (70 °C), and layer thickness having different occupancy rates (20%, 50%, 80%). Uniaxial tension tests, hardness measurement, and surface roughness measurements taken from samples.

Figure 1 shows printed standard tensile test samples using PET-G material.

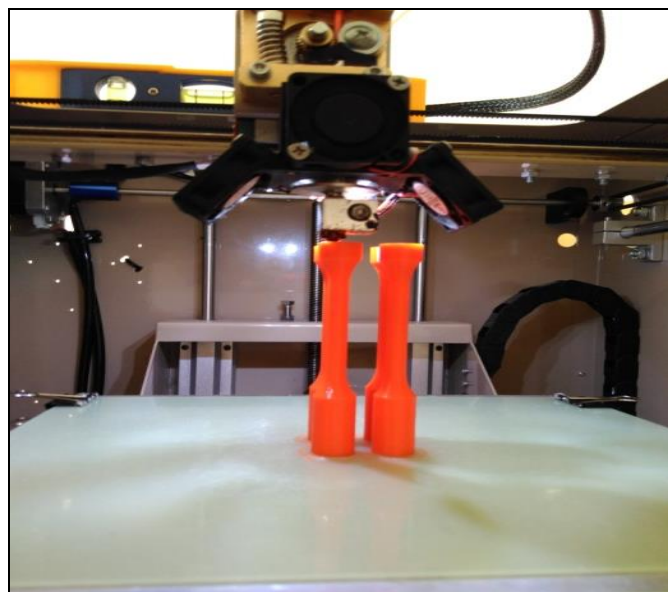

Figure 1. Printed Standard Tensile Test Samples From PET-G Material

Table 1 presents physical and chemical features of the PET-G material. Table 2 gives printing parameters.

Table 1. The Physical and Chemical Properties of the PET-G Material (Ahrabi, 2009).

<i>Material Properties</i>	
Material	PET-G
Filament color	Orange
Filament diameter (mm)	1,75
Density (g / cm ³)	1.27
Tensile Strength (MPa)	50
Tensile Modulus (MPa)	2140
Elongation at break (%)	120
Melting Point (°C)	135
Heat deflection temperature (°C)	70

Table 2. Printing Parameters.

<i>Printing Parameters</i>	
Filament diameter (mm)	1,75
Nozzle diameter (mm)	0,40
Extruder temp. (°C)	240
Table temp. (°C)	70
Occupancy rate (%)	20, 50, 80
Extrude width (mm)	1,00
Table height (mm)	0,15
Layer thickness (mm)	0,200
Printing speed (mm/s)	45
Filling structure	Rectilinear

Solid model of samples created with computer aided design program and manufactured with 3D slicing program on 3D printer using PET-G filament material with 1.75 mm diameter.

Standard (TS 138 - A) tensile sample dimensions are given in Figure 2. Printed tensile test samples are shown in Figure 3. Nine samples are manufactured and each of samples has three occupancy rates (20 %, 50 %, 80 %) of the PET-G plastic material.

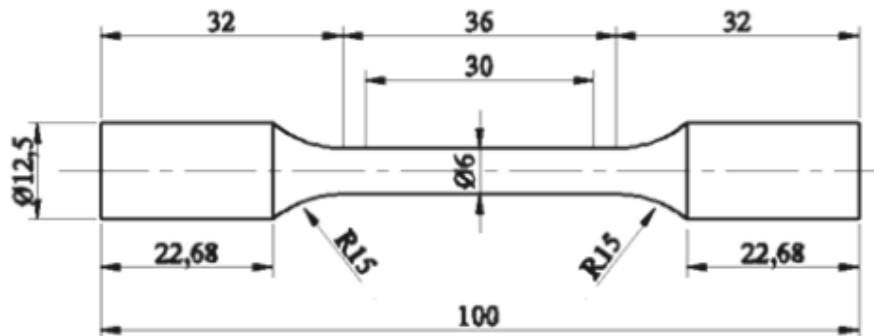

Figure 2. A Standard (TS 138-A) Tensile Test Sample Dimensions

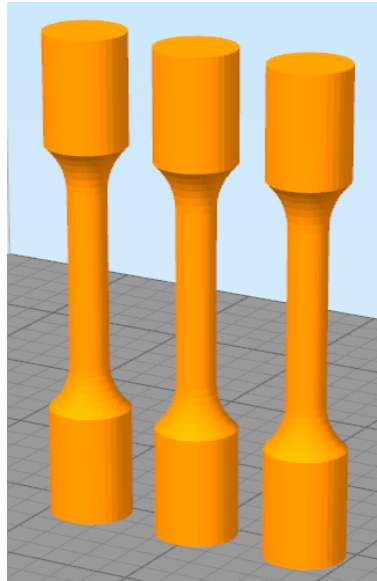

Figure 3. Printed Standard Tensile Test Samples

Rectilinear filling pattern shown in Figure 4 was used for printing tensile tests sample.

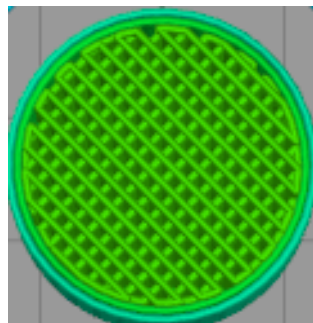

Figure 4. Image of Rectilinear Filling Pattern

Standard tensile test samples shown in Figure 5 have three different occupancy rates (20 %, 50 %, and 80 %). Each of samples is tested and compared under equal conditions. Tensile test speed was 2 mm/min.

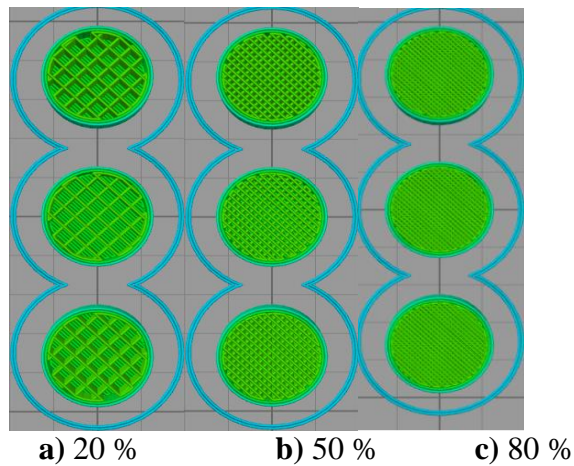

Figure 5. Occupancy Rates (%) of Tensile Test Samples

Tensile tests were conducted at Duzce University Science and Technical Research and Application Center Laboratory. Tensile test machine of brand BESMAK has 40 ton capacity used for tensile tests. A picture of tensile test machine is given in Figure 6.

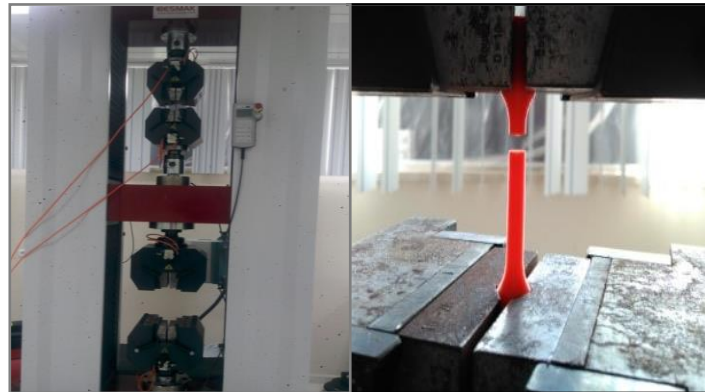

Figure 6. Tensile Test Machine

Before tensile test is conducted every sample measured for surface roughness. Shore D (SD) hardness measurement device was used, every sample was measured three times and average values of three values were determined and compared.

3. Results and Discussion

Tensile strength values for three tests are presented in Table 3 and elongations results are presented in Table 4.

Table 3. Tensile strength values for the tests.

Occupancy rate	<i>Tensile strength (MPa)</i>			
	1.Test	2.Test	3.Test	Average values
20 %	30,58	28,53	32,97	30,71
50 %	42,85	54,17	46,88	47,98
80 %	47,93	51,41	48,40	49,41

The average value of tensile strength of samples is increasing of occupancy rates. Samples with 20 % occupancy rates have average tensile strength value of 30,71 MPa and samples with % 80 occupancy rates have average tensile strength value of 49,41 MPa.

Table 4. Elongation values at break for the tests.

Occupancy rate	<i>Elongation at break (%)</i>			
	1.Test	2.Test	3.Test	Average value
20 %	0,46	0,51	0,44	0,47
50 %	0,30	0,32	0,32	0,31
80 %	0,22	0,23	0,20	0,21

It can be seen from Table 4 that the highest elongation average value is 0,47 % of samples with 20 % occupancy rate while the lowest elongation average value is 0,21 % of samples

with 80 % occupancy rate. Figure 7 gives plots of average tensile stress versus strain values with respect to occupancy rates.

Breaking elongation of occupancy rate of 20 % is taken much longer than of 50 % and 80 %. However, it has lower toughness comparing to occupancy rate of 50 % and 80 %. It should be noted that tensile strength does not change significantly for higher occupancy rate of 50 % and so using higher occupancy rate is not efficient in respect of process time.

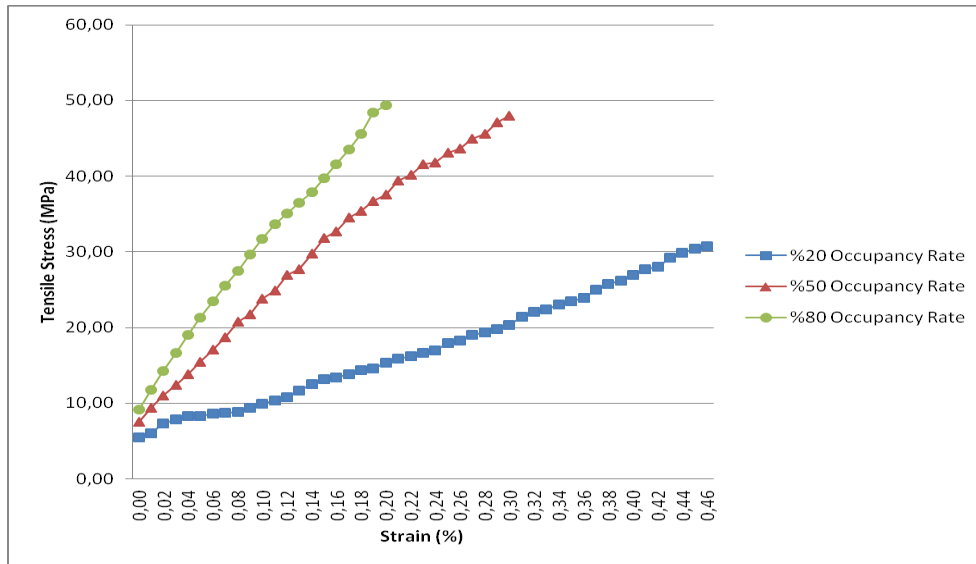

Figure 7. Average Tensile Stress Versus Strain Values for Occupancy Rate

Shore D hardness measurement test results are presented in Table 5.

Table 5. Shore D hardness test results.

<i>Shore D (SD) Hardness</i>				
Occupancy rates	1.Test	2.Test	3.Test	Average values
20 %	51	54	50	51,6
50 %	64	63	65	64
80 %	73	72	71	72

From Table 5, the highest hardness average value is 72 SD for samples with 80 % occupancy rate, while the lowest hardness average value is 51,6 SD for samples with 20 % occupancy rate. From the results it can be concluded that hardness measurements increase proportion to increase in occupancy ratio. Surface roughness average values are presented in Table 6.

Table 6. Surface roughness test results.

<i>Surface roughness averages (Ra)</i>				
Occupancy rates	1.Test	2.Test	3.Test	Average values
20 %	12,087	13,440	11,717	12,415
50 %	12,422	11,439	12,645	12,169
80 %	12,253	12,203	11,836	12,097

From Table 6, the highest surface roughness average value is 13,44 microns for occupancy rate of 20 % and the lowest surface roughness average value is 11,43 microns for occupancy rate of 50 %. It can be noted that surface roughness average values are close to each other for all occupancy rates. However there is little decreasing while occupancy rate increasing.

4. Conclusion

This study has given an account and the reasons for the widespread use of 3D printing. This study was aimed to investigate the effect of occupancy rates on mechanical properties and surface roughness of PET-G material products. The following conclusions can be drawn from the results of the uniaxial tensile test, hardness, and surface roughness measurements of samples; when the occupancy rate level increases, tensile strength average values increase and elongation average values decrease. Beside these, it does not necessarily lead to similar increase in surface roughness values.

5. References

- Ahrabi A.Z., 2009. Pet Atıkları Kullanılarak Kompozit Malzeme Üretimini Araştırılması, Üniversitesi Fen Bilimleri Enstitüsü Yüksek Lisans Tezi, Kimya Mühendisliği anabilim Dalı, Ankara.
- Bernard, Fischer, A., 2012. New Trends in Rapid Product Development, Industrial Engineering Research.
- Billiet, T., Vandenhoute, M., Schelfhout, J., Vlierberghe, S. V., Dubruel, P., 2012. A Review of Trends and Limitations In Hydrogel Rapid Prototyping For Tissue Engineering, *Biomaterials* 33, 6020-6041.
- Birtchnell, T., Urry, J., 2013. 3D, SF And The Future, *Futures* 50, 25-34.
- Calvert, P., 1998. Free Forming of Polymers, *Polymers*, 585-588
- Campbell, I., Bourell, D. and Gibson, I., 2012. Additive Manufacturing: Rapid Prototyping Comes Of Age, *Rapid Prototyping Journal*, 18 (4): 255-258.
- Campbell, I., Bourell, D., Gibson, I., 2012. Additive Manufacturing: Rapid Prototyping Comes of Age, *Rapid Prototyping Journal*, 255-258.
- Çelik, D., 2015. Tersine Mühendislikle Üç Boyutlu Yazıcı Tasarımı ve Üretimi Yüksek Lisans Tezi, Karabük Üni., *Fen Bil. Enstitüsü*.
- Chimento, J., Jason, M., Nathan Crane, H., 2011. 3D Printed Tooling for Thermoforming of Medical Devices, *Rapid Prototyping Journal*, 387–392.
- Dale Prince, 2014. 3D Printing: An Industrial Revolution, *Journal of Electronic Resources in Medical Libraries*, 39-45.
- Fantini, M., Crescenzo, F. D., Persiani, F., Benazzi, S., Gruppioni, G., 2008. 3D Restitution, Restoration and Prototyping of A Medieval Damaged Skull, *Rapid Prototyping Journal*, 318–324.
- Günther D., Heymel B., Günther F. J. and Ederer I., 2014. Continuous 3D Printing for Additive Manufacturing, *Rapid Prototyping Journal*, 20 (4): 320327.
- Kashdan, L., Seepersad, C. C., Haberman, M., Wilson, P. S., 2012. Design, Fabrication, And Evaluation of Negative Stiffness Elements Using SLS, *Rapid Prototyping Journal*, 194-200.
- Kroll, E. and Artzi, D., 2011. Enhancing Aerospace Engineering Students Learning With 3D Printing Wind-Tunnel Models, *Rapid Prototyping Journal*, 17 (5): 393 -402.
- Lee, C.S., Kim, S.G., Kim, H.J., Ahn, S.H., 2007. Measurement of Anisotropic Compressive Strength of Rapid Prototyping Parts, *Journal of Materials Processing Technology*, 627–630.
- Levy, G. N., Schindel, R. and Kruth, J. P., 1996. Rapid Manufacturing And Rapid Tooling With Layer Manufacturing (Lm) Technologies, State of The Art And Future Perspectives, 1 (1): 1-21.
- Marchelli, G., Prabhakar, R., Storti, D., Ganter, M., 2011. The Guide to Glass 3D Printing: Developments, Methods, Diagnostics And Results, *Rapid Prototyping Journal*, 187-194.
- Palousek, D., Rosicky, J., Koutny, D., 2014. Pilot Study of The Wristorthosis Design Process, *Rapid Prototyping Journal*, 27-32.
- Paulic, M., Irgolic, T., Balic, J., Cus, F., Cupar, A., Brajliah, T., Drstvensek, I., 2014. Reverse Engineering of Part Swith Optical Scanning And Additive Manufacturing, *Procedia Engineering*, 795-803.
- Pham, D. T. and Gault, R. S., 1997. A Comparison of Rapid Prototyping Technologies, *International Journal of Machine Tools & Manufacture*, 38 (1): 1257-1287.

- Piattoni, J., Candini, G.P., Pezzi, G., Santoni, F., Piergentili, F., Astronautica, A., 2012. Plastic Cubes At: An Innovative And Low-Cost Way To Perform Applied Space Research And Hands-On Education, *Act An Astronautica*, 419-429.
- Polzin, C., Spath, S., Seitz, H., 2013. Characterization and Evaluation of A PMMA-Based 3D Printing Process, *Department of Mechanical Engineering*, 37-43.
- Qiu, D., Langrana, N. A., 2002. Void Eliminating Tool Path Forex Trusion Based Multi-Material Layered Manufacturing, *Rapid Prototyping Journal*, 38-45.
- Ruffo, M., Tuck, C., Hague, R., 2007. Make or Buy Analysis for Rapid Manufacturing, *Rapid Prototyping Journal*, 23-29.
- Singare, S., Lian, Q., Ping Wang, W., Wang, J., Liu, Y., Li, D., Lu, B., 2009. Stereo Lithography Model; (B and C) Custom Made Implant and Stero lithography Skull Model Used In Preoperative Planning, *Rapid Prototyping Journal*, 19-23.
- Stephens, B., Azimi, P., El Orch, Z. and Ramos, T., 2013. Ultrafine Particle Emissions From Desktop 3D Printers, *Atmospheric Environment*, 79:334-339.
- Turner, B.N., Strong, R. and Gold, S. A., 2014. A Review of Melt Extrusion Additive Manufacturing Processes: I. Process Design And Modeling, *Rapid Prototyping Journal*, 20 (3): 192-204.
- Vaezi, M., Chianrabutra, S., Mellor, B., Yang, S., 2013. Multiple Material Additive Manufacturing-Part 1: A Review, *Virtual and Physical Prototyping*, 19-50.
- Kam, M., İpekçi, A. and Saruhan, H., Investigation of 3d printing filling structures effect on mechanical properties and surface roughness of PET-G material products. *Gaziosmanpaşa Bilimsel Araştırma Dergisi*. 2017;6(ISMSIT2017):114-121.