

Maximum Exergy Control of a Solar Thermal Plant Equipped with Direct Steam Collectors

Giampaolo Manfrida^{1*}, Vincent Gerard²

¹ Università degli Studi di Firenze, Dipartimento di Energetica "Sergio Stecco"
Via C. Lombroso 6/17 50135 Firenze

²Ecole des Mines de Douai
941 rue Charles Boursel, 59500 Douai, France

Abstract

The performance of solar thermal power plants is strongly affected by the radiation intensity, which is subject to large variations depending on the weather conditions and on the time of the year. The control system of the solar thermal energy conversion plant must take into account such variable conditions, introducing correct thermodynamic relations pursuing the minimization of exergy destruction. The advantage of introducing direct-steam solar collectors with respect to the use of a separate heat transfer fluid in the primary circuit is also demonstrated. The model simulation predicts a performance improvement - compared to traditional control laws - ranging from 10 to 20% depending on the reference month.

Keywords: Solar thermal energy conversion, maximum- exergy control.

1. Introduction

The production of electricity from solar radiation is a very desirable evolution of our present approach to energy conversion. Energy coming from the sun is certainly the largest source of renewable energy: the problem of its exploitation is that energy from the sun has relatively low intensity (seldom exceeding 1kW/m^2 of horizontal surface on the ground), and a very high dependence on meteorological conditions. This means that typically large losses to the environment are encountered (that is, low conversion efficiencies; usually lower than 20%); and that the high cost of equipment cannot be spread over long periods of continuous, maximum load operation.

The problems encountered in the development of large photovoltaic power plants have claimed attention for the more traditional and mature technology of solar thermal energy conversion.

This implies the use of concentrators (either a distributed array of Concentrating Parabolic Trough Collectors, CPTC; or a central-receiver solution with multiple mirrors). Several plants of this type are operational over the world, notably in California and in Spain (Mills, 2004). In these plants, the concentrated solar radiation produces steam in a steam generator; the steam is then expanded in a relatively conventional superheated steam power plant. Using CPTC collectors (which is currently the most followed option), heat is first transferred to a heat transfer fluid in liquid state (primary circuit); a steam generator (SG) feeds a conventional steam power cycle (*Figure 1*), usually featuring a mixing feedwater heater (MFH) which removes the non-condensable gas fraction from the steam circuit; the MFH also introduces regeneration within the steam cycle, and allows an adequately high inlet temperature to the collector field.

* Author to whom correspondence should be addressed. manfrida@unifi.it

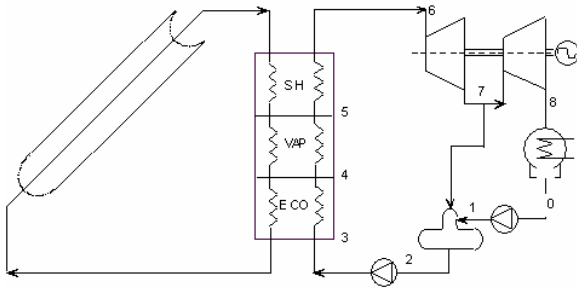

Figure 1. Solar thermal conversion power plant with dual circuit and mixing feed water heater.

2. Collector thermal and exergy efficiency – qualitative analysis

It is well known that the maximum amount of heat captured by a solar collector is achieved when its thermal dispersion to the environment is zero: that is, when the absorber is in thermal equilibrium with the environment.

However, if the heat converted from radiation is made available to a very low temperature level (in practice, in equilibrium with the environment), its usefulness is very small. This is well expressed by the exergy being very close to zero. The exergy output from the collector represents the amount of energy gathered from the sun which can be converted into work or electricity: it must first be transferred to the steam stream in the SG; and then converted into work within the steam cycle. The original collector exergy flow undergoes some degradation: first lowering of temperature level in the SG; and then irreversibilities within the steam cycle.

In practice, a solar thermal plant featuring a very low temperature level in the CPTC system will convert a large amount of radiation into heat; however, the efficiency with which this heat can be converted into electricity is very low. On the other hand, pushing the steam and SG parameters to extreme conditions can make the collector field operate close to the shut-off temperature (T_{so}), that is, the temperature for which all heat converted from radiation is wasted to the environment because the absorber temperature is too high.

Within these two extremes there is obviously a maximum condition, which is best formulated through the use of exergy.

3. Control of solar thermal power systems – traditional vs. exergy approach

Up to now, the attention of researchers (mainly faced with operation of prototype solar thermal plants) has been focused on reliability, simple maintenance and system dynamics (Camacho et al., 1997). In practice, the plant is operated with a constant value of T_{fo} – the

collector field outlet temperature. This is done through primary loop flow rate control (Cirre et al., 2006), making reference to pre-set operating conditions. A model of the plant, or fuzzy-logic governor, are used in a dual-layer control arrangement. The circuit usually includes recirculation for the control of T_{fo} : a three-way valve controls the return flow rate to the collector inlet, raising the local value of T_{fi-1} and taking advantage of temperature stratification in the storage, until the set-point T_{fo} is achieved (advanced controllers of the PID type are used for this task, trying to improve the time response of the system). The steam cycle is operated at constant design conditions (SG pressure and temperature), but the steam flow rate has to be adjusted (e.g., if solar radiation is low, less heat is produced – at the same temperature level - and the steam flow rate must be reduced accordingly) so that the turbine operates in off-design.

From a thermodynamic point of view, this way of controlling a solar thermal conversion plant makes little sense. For low solar radiation, it is clearly not worth trying to achieve high temperatures T_{fo} at collector outlet. It is more important to produce heat at lower temperature levels, sacrificing the steam cycle efficiency to the collector field efficiency. This means that the steam cycle should be operated in a sliding-temperature mode, and the steam turbine allowed to work at off-design conditions.

This is a qualitative description of the thermodynamic operation of the system: in order to get an exact idea of the potential offered by true thermodynamic optimization it is necessary to perform an exergy analysis of the collectors/plant system.

4. Exergy analysis - Solar thermal power plant with single-phase collectors

When a secondary heat transfer fluid is used, maintaining single-phase (liquid) through the collector, the maximum exergy output (MEO) control can be achieved under the conditions established by the following equations (Manfrida, 1985; Manfrida and Kawambwa, 1990 and 1991):

$$T_{fo} = T_{so} - d \quad (1)$$

$$T_{so} = 2T_a - T_{fi} + 2(A_o/A_r)[F' \beta \gamma (\tau \alpha)_e I] / (F' U_L) \quad (2)$$

$$d = \frac{(T_{fo} - T_{fi}) - T_a \ln \left(\frac{T_{fo}}{T_{fi}} \right)}{\left(\frac{T_a}{T_{fo}} \right) - T_a \left[\frac{\ln \left(\frac{T_{fo}}{T_{fi}} \right)}{(T_{fo} - T_{fi})} \right]} \quad (3)$$

In order to solve the set of Equations 1- 2- 3, a recursive procedure is needed: in fact, T_{fo} – the optimal output value of collector temperature – appears also in Equation 3 as one of the input values.

Equation 2 makes reference to a design approach to solar collectors, where the different loss terms are explicitly evaluated; however, the same procedure can be applied if the collector performance is known just from experimental tests. In such case, the shutoff temperature T_{so} is the measured or extrapolated value for which $\eta_{coll} = 0$. This approach allows also to model the variable collector heat loss factor, $F'U_l$, which is not constant but depends on the absorber temperature.

Most solar collector manufacturers provide a second-order polynomial fit describing η_{coll} vs. $X = [(T_{fo} + T_{fi})/2 - T_a]/I$, of the type (Duffie and Beckman, 1984; POSHIP Report, 1999):

$$\eta_{coll} = A - B X - C I X^2 \quad (4)$$

Figure 2 shows (a) the typical graphical representation of the collector thermal efficiency curve; (b) the effective location of the maximum exergy output conditions for three different values of radiation.

The maximum conditions shown in Figure 2 (b) are numerically determined for collectors with variable heat loss factor $F'U_l$; in practice, curves are searched from the left (shutoff conditions, low thermal efficiency) for raising values of the exergy output; when the exergy output starts to decrease, the solution for the maximum is refined by chord interpolation.

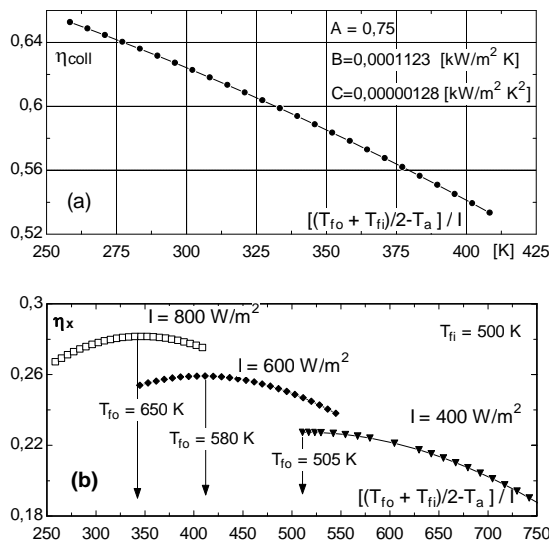

Figure 2. (a) Collector thermal efficiency; (b) Collector exergy efficiency.

Once T_{fo} has been thus determined, one can calculate the steam outlet temperature as $T_{sh} = T_{fo} - DT_{appr}$ and proceed with the SG balance and steam cycle calculations. Equations 1 to 4 take care of minimizing the exergy destructions in converting the solar radiation into heat, namely:

ED_{Coll_L} the collector heat loss
 ED_{Coll_HT} the collector heat transfer exergy destruction

However, the complete solar thermal conversion plant involves several other contributions to exergy destruction:

ED_{SG} the Steam Generator heat transfer exergy destruction
 ED_{ST_HP} the High-Pressure Steam Turbine irreversibility exergy destruction
 ED_{ST_LP} the Low-Pressure Steam Turbine irreversibility exergy destruction
 ED_{MFH} the Mixing Feedwater Heater exergy destruction
 ED_{COND} the Condenser exergy destruction

The pump irreversibility exergy destruction is very small and can be disregarded.

In order to demonstrate the advantage of using the Maximum-Exergy-Output (MEO) control concept, simulations were run using a model developed in EES (Engineering Equation Solver) software. The model can be run with any set of meteorological data; results presented in the following were produced using average values calculated from experimental data in Firenze, Italy, from 1993 to 2003. The collector field was set at a fixed tilt angle corresponding to the latitude, with hourly tracking from east to west. A total of 1000 collectors of reference size 1,5 x 5 m, for a total of 7500 m² for the solar field, was considered; the collector parameters A, B and C are shown in Figure 4 and correspond to advanced design levels as can be found in the technical literature (SOLEL, 2007).

The MEO controller, with respect to a traditional, fixed DT type is able to decrease ED_{Coll_L} – the major system exergy destruction - in hours of reduced radiation (Manfrida, 2006). The advantage of MEO is evident when considering the daily trend of the whole system conversion efficiency, which is shown in Figure 3.

The better performance of the MEO control is the result of the optimized exergy balance over the day, as is shown in Figures 4 and 5 for the reference day in June.

From Figures 4 and 5, it can be clearly seen that the main result of MEO control is the decrease of ED_{Coll_L} in hours of reduced radiation.

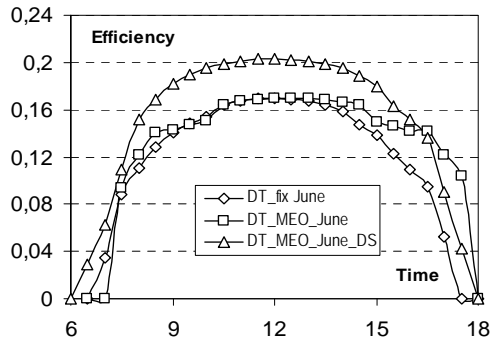

Figure 3. Overall system efficiency over a typical day in June. \diamond Fixed-DT control; \square MEO single-phase collector; \triangle MEO Direct Steam collector.

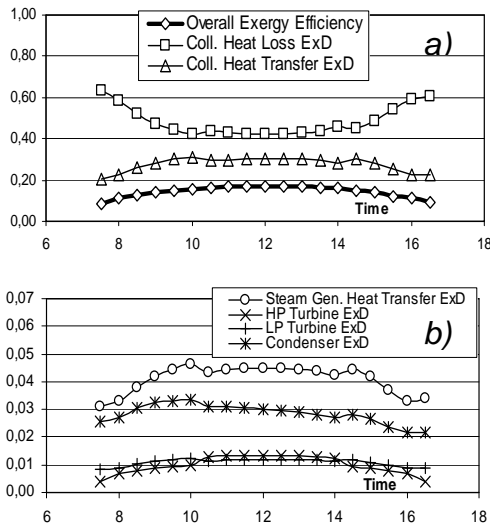

Figure 4. Exergy balance, Fixed-DT control, Single-Phase Collectors – June. (a) Efficiency and major ExDs (b) Minor ExDs.

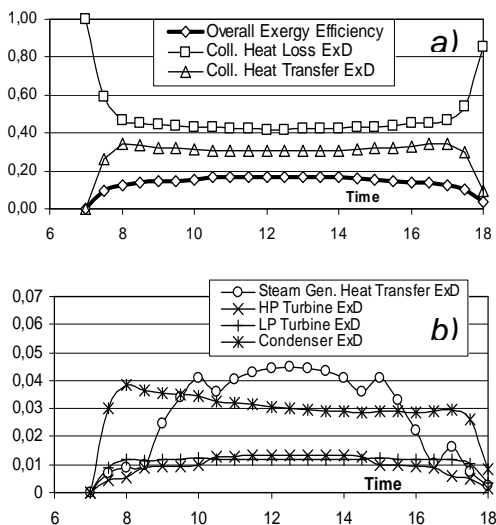

Figure 5. Exergy balance, MEO control, Single-Phase Collectors – June. (a) Efficiency and major ExDs (b) Minor ExDs.

In order to achieve this, one must tolerate an increase in $ED_{Coll-HT}$; the other exergy destructions are small and are moderately affected by the control law.

On the whole, it is relevant to consider year-round operation: such a comparison is shown in Figure 6. Here, four conditions for primary flow rate control are compared:

- The value of $DT = T_{fo} - T_{fi}$ is kept constant to 155°C (the optimal value for the reference day in June) all the year round
- The value of DT is kept constant over the whole reference day of the month to the optimal value for highest daily collector exergy output. This typically happens between 12:00 am and 1:00 p.m., depending on the month. Using this type of long-term-adjusted control, DT_{fix} is lowered in months of low radiation.
- MEO: The value of DT is continuously adjusted over the day to guarantee the highest instant collector exergy output.
- Like (c) - MEO with direct steam production in the solar collectors (Section 5)

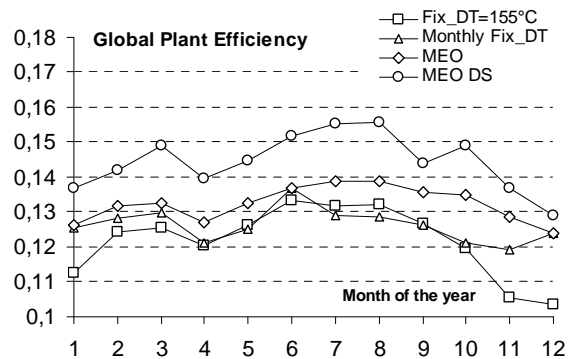

Figure 6. Long-term (year-round) comparison of four different operating options. Overall plant.

5. Exergy Analysis - Solar thermal power plant with two-phase (direct-steam) solar collector

The use of two circuits, a primary one with collector heat transfer fluid (a special oil for high-temperature operation), and a secondary steam/water one arranged as a superheated steam cycle, is recognized by most researchers in the field of solar thermal energy conversion as a constraint limiting the performance of the system. This can also be demonstrated by exergy and pinch analysis considerations: when coupling (in the steam generator) two streams having locally different heat capacities it is inevitable to generate large irreversibilities and heat transfer exergy destructions (even if to some extent this goes to the advantage of limiting the heat transfer surface) (Bejan, 1988; Bejan et al., 1996).

The shortcomings of using direct steam generation (DSG) inside the collectors are

several: among the most challenging, guaranteeing pressure tightness in a distributed system (with special reference to solar farm solutions) with large inside pressures; and maintaining adequately high values of heat transfer coefficient even in the superheated vapour phase. A thorough discussion of the advantages and technical challenges posed by DSG collectors, including heat transfer and pressure drop issues, has been presented by Odeh (202). As a result, pilot testing on DSG parabolic trough collectors is well on the way in several facilities (Eck et al., 2003; Zarza and Hennecke, 2000).

A simplified reference circuit for the direct steam case, which can be compared to the conventional arrangement of *Figure 1*, is represented in *Figure 7*.

Control laws for solar thermal power production have also been developed for plants equipped with direct-steam collectors (Valenzuela et al., 2005; Cirre et al., 2007). Here again, it is possible to implement Maximum Exergy Output control for the Direct Steam collector case (MEO_DS) without major difficulties.

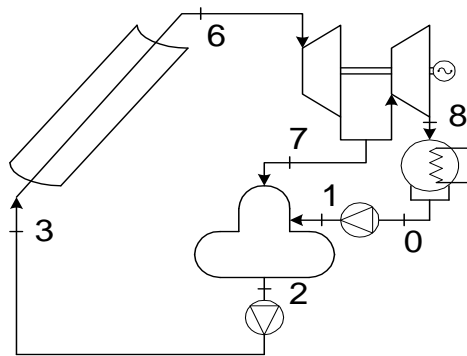

Figure 7. Solar thermal conversion power plant with direct steam collectors.

As in the previous case, for given environmental conditions a maximum exergy output operating point exists, when considering as the main control variable the average collector temperature $T_{av,DS}$ (which is used as the control variable instead of the collector exit temperature T_{fo} , as was done in the case of the single-phase collector). It is however important to correctly define the value of $T_{av,DS}$: in fact, a large part of the collector operates under phase transition, that is, at constant temperature; however, there exist a sub-cooled liquid and a superheated steam section. The entropy-mean temperature has been considered the most correct thermodynamic temperature value:

$$T_{av,DS} = (h_3 - h_6)/(s_3 - s_6) \quad (5)$$

Accordingly the value of X for the solar collector thermal efficiency (Equation 4) is defined as:

$$X = [T_{av,DS} - T_a]/I \quad (6)$$

The instant MEO condition can be determined – as in the previous case - by a numerical search for the maximum with variable T_3 . However, it is necessary to introduce a limiting upper value for technological reasons (this limit is actually reached around noon for summer months). In the reference case whose results are presented, a limit value of $T_{3L} = 800$ K was assumed. When this technological limit is reached, the control law automatically switches to fixed mode with $T_3 = T_{3L}$, until the changed environmental conditions allow return to the MEO mode (typically, when radiation is decreased).

The exergy balance for the direct steam case, operated in MEO mode, is shown for the reference day of June in *Figures 8a* and *8b*, which can be directly compared to *Figures 4* and *5*.

The remarkable increase in conversion efficiency, scoring an average of 0,152 over the day, is obtained through the suppression of the SG heat transfer exergy destruction.

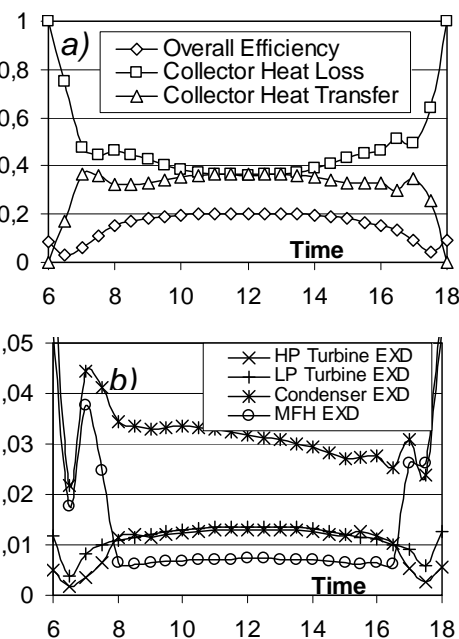

Figure 8. Exergy balance, Direct Steam Collectors with MEO – June.

8a) Efficiency and Major ExD; 8b) Minor ExDs.

6. Conclusions

The application of Maximum Exergy Output control to solar thermal energy conversion plants can improve considerably the performance of this type of power plants. This is a relevant factor, neglected up to now in existing plants, which are

operated at present with control laws which tend to satisfy reliability of operation and preset design steam conditions imposed by common steam turbine practice; the still high plant build-up and maintenance costs render even more attractive the MEO control option, which can be implemented in these plants at very low cost.

A numerical model of the solar thermal energy conversion plant has been built, and four different plant operation modes have been simulated and compared under equal conditions:

- a) Single-phase collectors, Fixed-DT flow rate control (traditional; DT = 155 °C)
- b) Single-phase collectors, Monthly-adjusted Fixed-DT flow rate control
- c) Single-phase collectors, Instant MEO flow rate control
- d) Direct Steam Collectors, Instant MEO flow rate control

The monthly performance of the four operation modes clearly indicate the progressive performance improvement passing from mode (a) to mode (d).

As a global indicator, one may refer to the average global efficiency of the solar thermal plant, which scores respectively 0,122, 0,126, 0,132 and 0,145 under the four operation modes here considered.

Even if the global year-round efficiency is low, MEO guarantees 1 percentage point more in efficiency over the base value of 0,122 for single-phase collectors; and about 2,3 percentage points more for direct steam, MEO.

The advantages of direct steam generation in solar thermal collectors are evident, even if this technical solution implies relevant complications in collector and solar field design.

On the whole, the results obtained applying Maximum Exergy Output control concepts are considered very appealing, as they are obtained with limited plant modifications and cost, just working on the control law of the plant.

Nomenclature

A_o	Surface of collector mirror	[m ²]
A_r	Absorber surface	[m ²]
DT	Temperature difference	[K]
ED	Exergy destruction	[kW]
F^r	Absorber efficiency	
I	Direct radiation on inclined surface	[W/m ²]
T	Temperature	[K]
U_L	Collector heat loss factor	[W/m ² K]
X	Abscissa for collector efficiency plot	
α	Absorption coefficient	
β	Mirror reflectance coefficient	

γ	Coefficient of interaction collector/absorber
η	efficiency
τ	Optical transmission coefficient of glass cover

Subscripts:

a	ambient
appr	approach
av;DS	average, direct steam
coll	collector
fi	collector fluid inlet
fix	fixed value (constant)
fm	average of fi and fo
fo	collector fluid outlet
SG	steam generator
o	overall
s	saturation
sh	superheated
so	shut-off (stagnation value)
x	exergetic

References

- Bejan, A., 1988, *Advanced Engineering Thermodynamics*, John Wiley & Sons, New York.
- Bejan, A., Tsatsaronis, G., Moran, M., 1996, *Thermal Design and Optimization*, Wiley Interscience, New York.
- Camacho, E., Berenguel, M., Rubio, F.R., 1997, *Advanced Control of Solar Plants*, Springer-Verlag, London.
- Cirre, C.M., Berenguel, M., Valenzuela, L., Klempous, R., "Reference governor optimization and control of a distributed solar collector field", *European Journal of Operational Research*, 2007, doi:10.1016/j.ejor.2007.05.056.
- Duffie, J.A., Beckman, W.A., 1984, *Solar Energy Thermal Processes*, Wiley, New York.
- Eck, M., Zarza, E., Eickhoff, M., Rheinlander, J., Valenzuela, M., 2003, *Applied research concerning the direct steam generation in parabolic troughs*, *Solar Energy* Vol. 74, N. 4, 341-351.
- Manfrida, G., 1985, *The Choice of the Optimal Working Point for Solar Collectors*, *Solar Energy*, Vol. 34, N. 6.
- Manfrida, G., Kawambwa, S., 1990, *A Two-Phase Solar Collector Powering a Rankine Organic Cycle*, *World Renewable Energy Congress*, Reading, U.K.
- Manfrida, G., Kawambwa, S., 1991, *Exergy control for a flat-plate Collector/Rankine Cycle Solar Power System*, *ASME J. of Solar Energy Engineering*, Vol. 113, 89-93.
- Manfrida, G., 2006, *Miglioramento delle prestazioni di sistemi di conversione di energia solare termica mediante controllo a minimizzazione di distruzione di energia*, (in

Italian),Atti 61mo Congresso Nazionale ATI, Perugia.

Mills, D., 2004, *Advances in solar thermal electricity technology*, Solar Energy 76, pp. 19-31.

Odeh, S. D., “*Unified model of solar thermal electric generation systems*”, Renewable Energy 28, 2003, 755-767.

SOLEL, 2007, “*UVAC Clean Power Generation*”, Technical brochure, www.solel.com.

The Potential of Solar Heat for Industrial Processes, (POSHIP) Final Report, European Community Project NNE5-1999-0308.

Valenzuela, M., Zarza, E., Berenguel, M., Camacho, E.F., 2005, *Control concepts for direct steam generation in parabolic troughs*, Solar Energy 78, 301-311.

Zarza, E., Hennecke, K., *Direct Steam Generation in parabolic troughs (DISS)*, 10th Solar aces International Symposium on Solar Thermal Concentrating Technologies, Australia, 2000, 65-71.