



The Effects of Coating Obtained by DC Reactive Magnetron Sputtering Technique on the Wear Performance of Engine Parts

Şengül DANIŞMAN^{1,*}, Oğuzhan BENDEŞ²

¹*Erciyes University, Faculty of Engineering, Department of Mechanical Engineering, Kayseri*

²*TEMSAN, Turkish Electromechanics Industry, Department of Technology Development, Ankara*

Received: 05/11/2012 Accepted: 07/06/2014

ABSTRACT

In this study, TiAlN coating obtained by using the magnetron sputtering method was deposited on steel materials used in automotive engine parts. The characterization and wearing properties of the coatings were investigated. The distance between the target and the coating was kept constant during the operation. TiAlN coatings were deposited on base materials (AISI 4150) using selected parameters (0,-100V and-200V bias voltages and 0.3 mtorr, 0.6 mtorr, 1.2 mtorr pressures). Hardening and nitriding processes were applied to the base materials. The coating characteristics of hardened and hardened + nitrided samples, surface properties and wear behavior were compared. The best results for the coating characteristics were determined. It was found that the hardened + nitrided of AISI 4150 samples with high nitrogen pressure (1.2 mtorr) gave the best wear resistance which resulted in a decreased coefficient of friction and a reduction in wear rates

Keywords: *Magnetron sputtering method, TiAlN, Engine Parts, Wear, Coatings Characteristics*

1. INTRODUCTION

Wear is one of the most important problems in internal combustion engines. The behavior of friction and wear characteristics is as important as other mechanical and chemical characteristics in engine parts. The most important cause of wear in engine parts is friction due to surfaces moving against each other. Friction is caused when surfaces are moved relative to each other or two surfaces are forced to move in spite of resistance to movement. The main factors to increase wear are pressure, sliding rate, coefficient of friction, surface morphology, modulus of elasticity, strength of material, resistance of fatigue and corrosion.

Surface coatings provide wear and corrosion resistance, design flexibility and many features for materials and as a result have found many application sectors in industry in general, and in the automotive industry in particular[1]. They have been increasingly in demand by the automotive industry in recent years due to their properties to reduce loads (mechanical, thermal, etc.), ensure longer operating life, reduce weight and friction, and increase corrosion resistance in engine parts[2]. Studies on this issue have revealed that friction and wear characteristics are optimized by applying surface and coating methods but the use of classic coating methods suffer from problems of adhesion. However, PVD methods have a lower processing temperature and good substrate and bond strength and, as a result, PVD methods are preferred to classic coating methods [3]. The PVD process can be

*Corresponding author, e-mail: sdanisman@erciyes.edu.tr

applied at temperatures lower than 250 °C. Many engine parts, bearing or hardened steels are very susceptible to heat which may result in significant changes in hardness and dimensional accuracy at temperatures above 200 °C [4]. If the material of a piston ring is cast iron and has a thicker than 4 µm multi-layers coating this improves wear characteristics[5]. Automobile manufacturers try to produce eco- friendly vehicles which use energy more efficiently; these vehicles take advantage of more efficient exhaust gas, various fuel injection systems (common rail, multiple injections), use different types of alternative fuels such as natural gas and hydrogen, reduce the average weight, and reduce energy losses and wear. The power loss from friction in motor parts is 15%. Most wear occurs in the cylinder liner regions / piston / piston ring interface. In addition, movement of the crankshaft, valve systems and the injection pump also plays a role in these losses which can be reduced by thin coatings such as TiN, TiCN and TiAlN. These coatings TiN and TiAlN provide longer life than TiCN in engine oil[6].

For the purpose of this study, a hard ceramic coating (TiAlN) was performed on selected AISI 4150 samples which were used in different motor parts (piston rings, injectors, pistons, gear, shaft etc.) so as to obtain a low friction coefficient, to achieve good wear advantage and to increase engine performance.

2. COATING METHOD

The PVD (Physical Vapor Deposition) method is mainly based on sputtering and evaporation in the materials under vacuum and involves the removal of atomized material from the substrate surface after the bombardment of its surface layer by ions or atoms. In general the PVD method has two processes: sputtering and evaporation. Sputtering is basically the removal of atomized material from a solid by energetic bombardment of its surface layer which is dependent on the exchange of momentum. The high energy particles used are usually those of a heavy inert or reactive gas (argon, the most commonly used inert gas) or the coating material forms a positive ion. The sputtering material is thrown in an atomic state from the coating material which is called the target. The base material is placed in front of the target to interrupt the flow of sputtered atoms [1]. Figure 2.1 shows the principle of the DC sputtering method.

Magnetron sputtering is a coating technique that is used to produce thin films with magnets placed behind the target in order to limit the plasma; also, the film layer has different properties and is achieved by changing the deposition parameter and target (coating material supply) configurations. The magnetron sputtering method was used in this study.

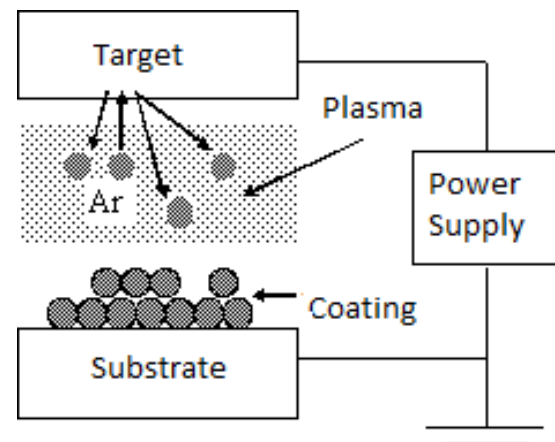

Figure 2.1. Principle of the DC sputtering method

3. EXPERIMENTAL STUDY

3.1. Sample Preparation

The samples were prepared from the base material AISI4150 (DIN 50CrMo4) whose chemical composition is shown in Table 3.1. They were 22 mm in height and had a diameter of 8 mm. Some of the samples were hardened and others were hardened + nitrided before coating. The plasma nitriding parameters are given in Table 3.2. Before being placed in the vacuum chamber, the samples were mechanically polished and ultrasonically cleaned in alcohol and also in acetone for 10 minutes each , and then dried.

The samples were coated with TiAlN by using the PVD-magnetron sputtering method. The distance between the target and the coating was kept constant (11 cm) during the coating process. The TiAlN coatings were produced at different nitrogen (N₂) pressures (0.3, 0.6, 1.2 mtorr) and bias voltages (0, -100, -200 V) by using a TiAl compound target (atomic Ti50%-Al50%). Then all the coated samples were examined for their structural, mechanical and tribological properties and the coating parameters were investigated as to the effect of coating properties.

The coating adhesion characteristic was measured with a CSEM scratch tester and a multi-pass sliding wear system, “ the Rugosimeter Wear Profile Measurement Device “ was used to examine wear behavior. The coatings obtained with different parameters were examined by comparing their tribological and mechanical properties and comments were made. The cross – sections of nitrided AISI 4150 steel samples were examined and the diffusion and white layer thickness (100 and 9.63µm respectively) were also determined by SEM as shown in Figure 3.1. The hardness of the diffusion layer and substrate were measured under 100 g load by a Struers microhardness device. The results obtained are summarized in Table 3.3 and in Table 3.4. There we see that the hardness of the diffusion layer for AISI 4150 is approximately 870 HV.

Table 3.1. Chemical composition of materials used in experimental study

Elem. (%)	C	Si	P	Co	Mn	Ni	Cr	Mo	V	W	Fe
4150	0.48	0.26	0.018	0.013	0.84	0.12	1.04	0.17	0.016	0.005	Bal.

Table 3.2 Parameters of plasma nitriding process.

Time (hr.)	Temp. (°C)	N ₂ /H ₂ ratio	Pressure (Pa)
10	500	4/1	200

The coating process applied to AISI 4150 and the silicon chips was conducted as follows: A pressure of 5 mtorr (~25 scem) and target power of 4500 W were used for about 5 minutes to clean the target, then a pressure of 5

mtorr, a target voltage of 150 W and DC voltage of 750 V were used for about 25 minutes to clean the base material.

Table 3.3. Hardness of samples before and after hardening and the roughness after polishing

Material	Hardness of material before hardening (Base material)	Hardness of material after hardening	Roughness R _a (µm)	
			Hardn.	Hardn. + Nitriding
4150	210.1 HV	515.5 HV	0.05	0.05

Table 3.4. Characteristics of the samples after plasma nitriding

Material	Thickness of diffusion layer (µm)	Thickness of white layer (µm)	Hardness of diffusion layer (HV)	Hardness of base material (HV)
4150	~100	9.63	867	515.5

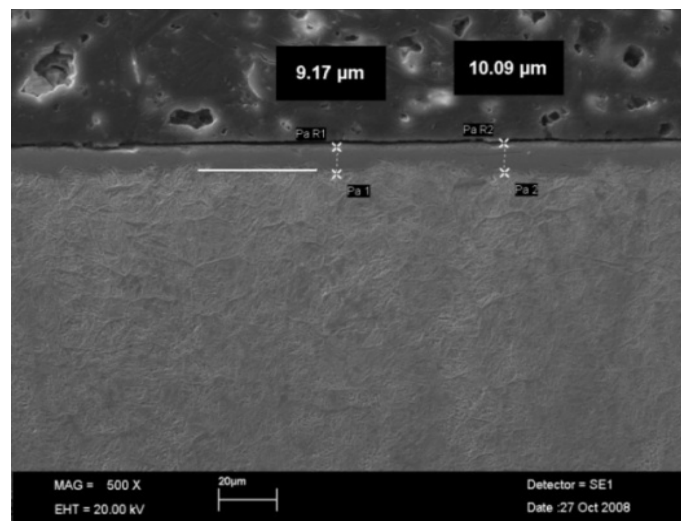

Figure 3.1. Cross-sectional SEM image of plasma nitriding of AISI 4150 steel

First of all, the TiAl coating was applied at a target power of 4000 W and 15 sccm argon flows for 30 seconds and then the TiAlN coating was applied using a target power of 4000 W and argon + N₂ atmosphere in the coating process. Different N₂ pressures and bias voltages were chosen as coating process parameters. The coating process was repeated for 0.3, 0.6 and 1.2 mtorr nitrogen

pressures and 0, (-) 100 and (-) 200 V bias voltages. The total operating (Ar+N₂ pressure) pressures were, respectively, 1.8, 2.1 and 2.7 mtorr. The distance between the samples and the target was 11 cm using a stainless steel holder which was fixed in front of the TiAl target during the coating process. The coating parameters for the AISI 4150 base material are summarized in Table 3.5.

Table 3.5. Coating parameters for AISI 4150 base material

Coating No	Bias Voltage (V)	N ₂ Pressure (mtorr)	TiAl Target Power (W)	TiAl Coating Time (sec.)	TiAlN Coating Time (min.)
1	0	0.3	4000	30	45
2		0.6			
3		1.2			
4	100	0.3	4000	30	45
5		0.6			
6		1.2			
7	200	0.3	4000	30	45
8		0.6			
9		1.2			

3.2. Wear Tests

The wear tests of the AISI 4150 samples coated with TiAlN were performed on a CSEM – Revetest scratch tester and used multi-pass sliding wear tests. Al₂O₃ ceramic balls with a diameter of 3.175 mm and a hardness of 1365 HV were used as wearing part in the wear tests. The normal force, F_N was kept at a constant

rate (15N), and a sliding distance of 2 mm for the table feed rate control was provided by the computer. Friction force (F_S) depending on sliding distance was recorded simultaneously. A schematic diagram of the device is given in Figure 3.2.

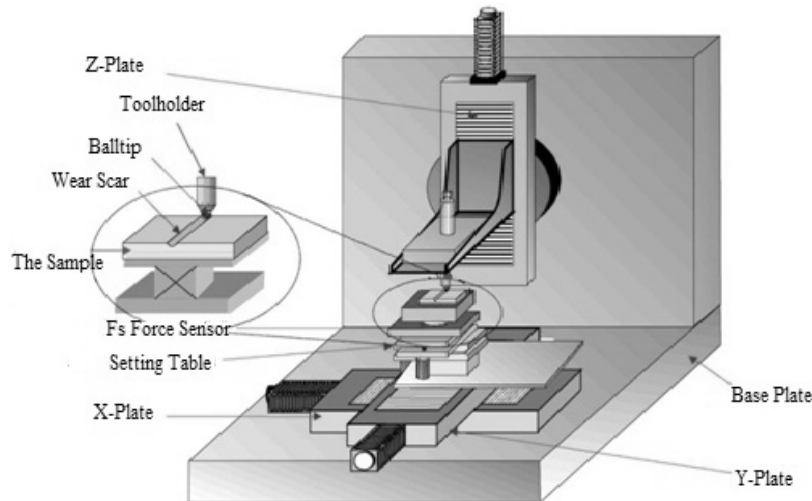

Figure 3.2 Schematic diagram of the device

The normal force depending on sliding rate and sliding distance was selected. After the full movement of the ball on the sample (Figure 3.3 a) was completed, the tip automatically returned to the starting point and then the second cycle started again by computer control. This cycle continued until the number 100 was reached. The

trajectory of the wear element is shown in Figure 3.3b. The results of the wear test obtained the wear volumes of the samples from Profilometer measurements which were used to calculate wear rate as a measure of wear. Similar systems were used in some studies in the literature [7-9].

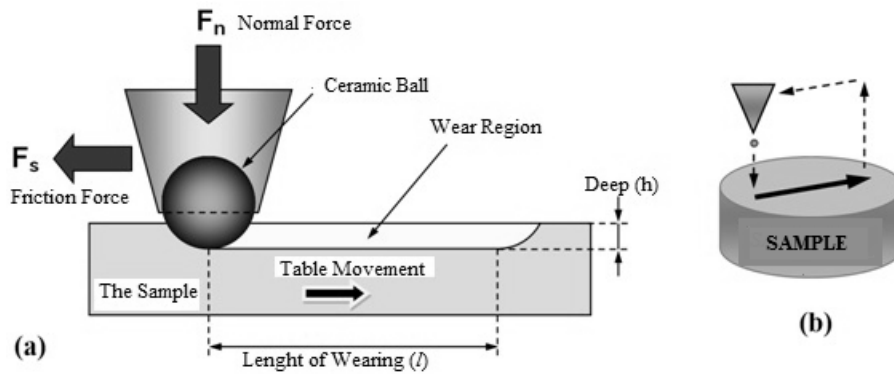

Figure 3.3 a) The geometry of the contact and forces of wear element-samples used in wear tests, b) The trajectory of the wear element

4. EXPERIMENTAL RESULTS AND DISCUSSION

The coating thickness of the samples was determined by examining the SEM images of the silicon chips. The deposition rate of the samples was calculated in terms of nm/min taking into account 45.5 minutes of coating time (the thickness of metallic coating was added to the total of the coating thickness). In addition the CSEM Calotest coating device measured the samples, thickness and approximately verified them. The thickness of the

coatings and deposition rates are summarized in Figure 4.1.

The silicon chip cross-sectional SEM images of the coatings (0V, -100V, -200V bias voltages) are shown in Figure 4.2. The thickness of the coatings is very stable and has a relatively columnar structure which can be seen on the images. The coating parameters are given according to deposition rate change in Figure 4.3 which shows a decrease in nitrogen pressure as the deposition rate increased.

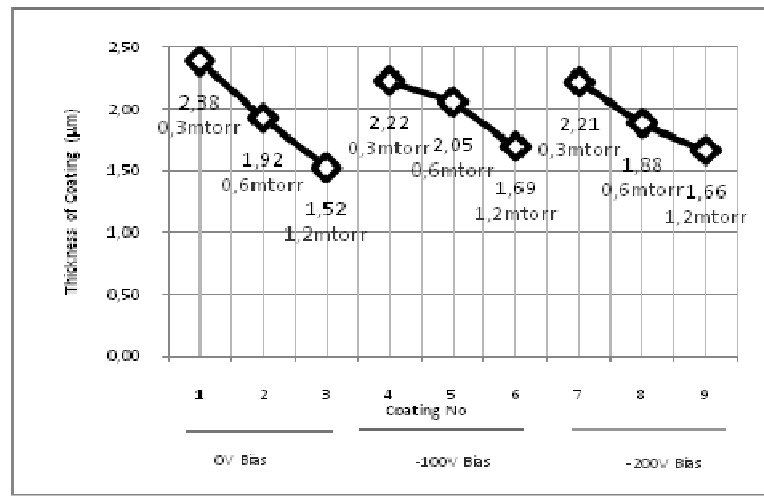

Figure 4.1. Thickness of TiAlN coatings deposited on silicon chips

This result is also consistent with that found by Wuhrer et al [10]. They reported that the deposition rate of the coatings decreased at high nitrogen pressure. The poisoning of the magnetron targets, and reducing the number and kinetic energy of the species approaching the substrate caused, besides grain structure are the more coarser than at low nitrogen pressures. On the other hand, the bias voltage applied to the samples can be an important parameter and closely affects film density, particle size and morphology [11]. Tanaka et al. were pointed out that TiAlN coatings deposited by reactive magnetron sputtering at zero bias voltage were associated with an open porous columnar structure resulting in inferior hardness [12]. Hakansson et al. however reported

that as the bias voltage increased, this open porous columnar structure was suppressed with a substantial hardness enhancement [13]. The thickness of the coating was not affected by change in bias voltage in this study.

The hardnesses of deposited TiAlN coatings on silicon chips were measured in accordance with the Oliver – Pharr method by a CSEM nano-hardness tester using a square-based diamond Vickers tip. Increasing the coating hardness with bias voltage at different pressure values (0,3, 0,6, 1,2 mtorr) did not result in further changes. This result is similar to the hardness results of nitride coatings in another study which showed that a significant change cannot be achieved by increasing the applied bias voltage

on a base material [14]. Also, in the literature [15], it was found that hardness could be improved in samples with a high percentage of nitrogen as was seen in this study. In addition, the graphs in Figures 4.3 and 4.4 show that the hardness of the samples is comparably lower which have higher Al% ratio (number of 1 and 7). It is noted that the current hardness values of the TiAlN films on Si wafer slides are lower than those depositions on steel substrates due to substrate effects [11].

Scratch tests for the AISI 4150 samples were subjected to test strength of 150 N (duration 1 min,) for a distance of 15 mm by the CSEM Revetest scratch tester. The Rockwell C type, which has a 200 µm radius tip and a 120° angle conical diamond tip, was used in the tests. A

load application rate of 100 N/min and a scratch rate of 10 mm/min were used. The appropriate emission graph can be obtained by changing acoustic emission intensity between 0-1.2. The results for the critical load (Lc) of the base material according to different pressure values at different bias voltages are shown in Figure 4.5. In general, the results of the samples showed that the critical load (Lc) values of the nitrided samples were higher. This result shows that coating bonded to the base material with better adhesion in the nitrided samples of the base material. Increasing surface roughness for better adhesion force and increasing the strength of the base material to prevent deformation resulted in the increased adhesion of the coating layer by the nitriding process.

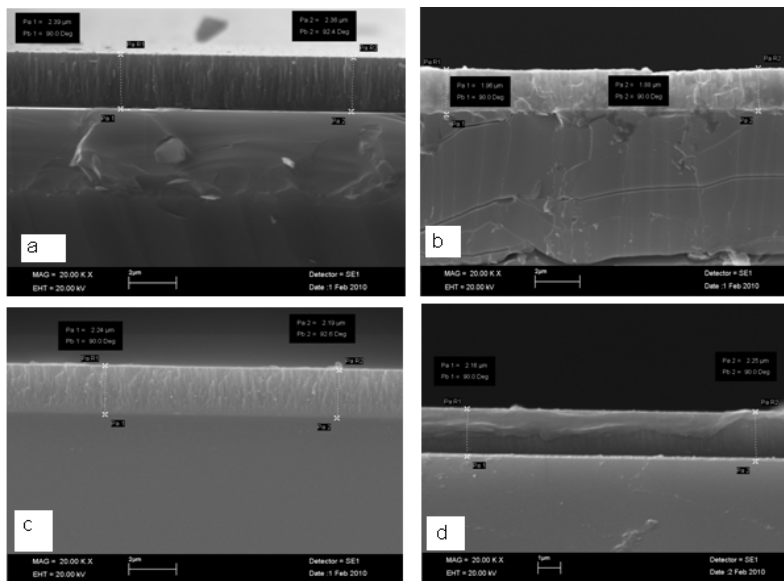

Figure. 4.2. (a) sample no 1 (0V, 0.3 mtorr) cross-sectional view, (b) sample no 2 (0V, 0.6 mtorr) cross-sectional view, (c) sample no 4 (-100V, 0.3 mtorr) cross-sectional view,(d) sample no 7 (-200V, 0.6 mtorr) cross-sectional view

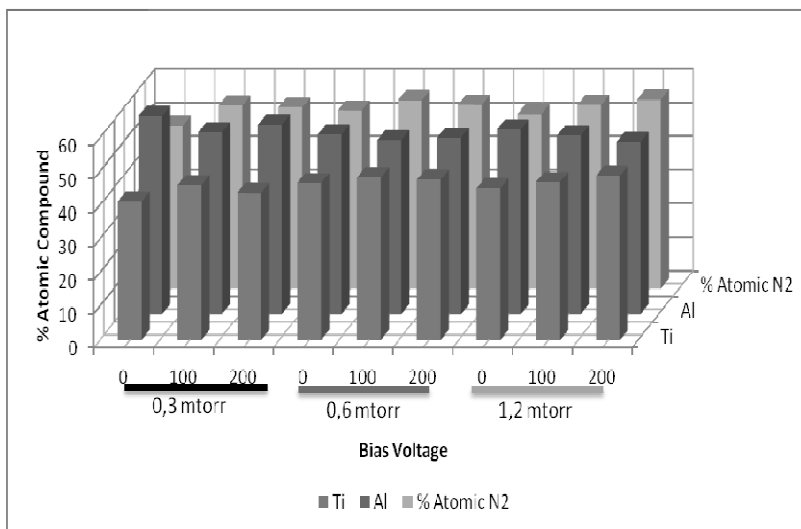

Figure 4.3. Graph of Al / Ti ratio changes depending on coating parameters

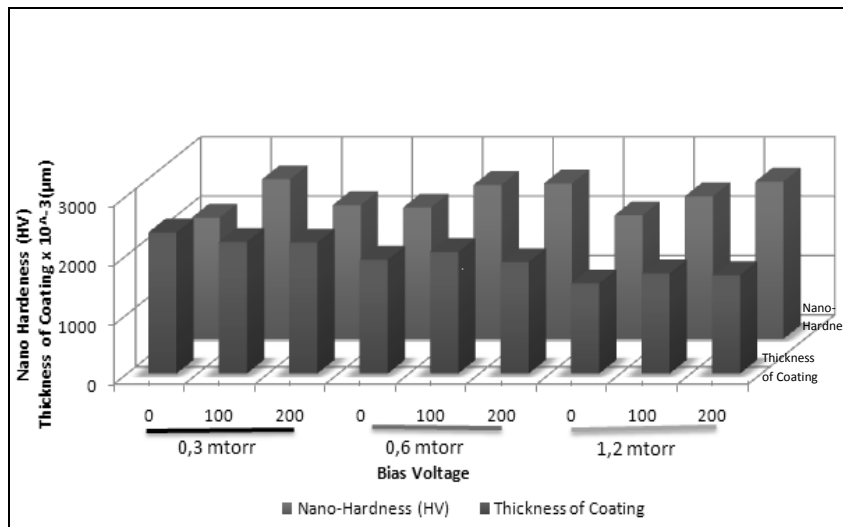

Figure 4.4. Graph of TiAlN coatings' nano-hardness and coating thickness

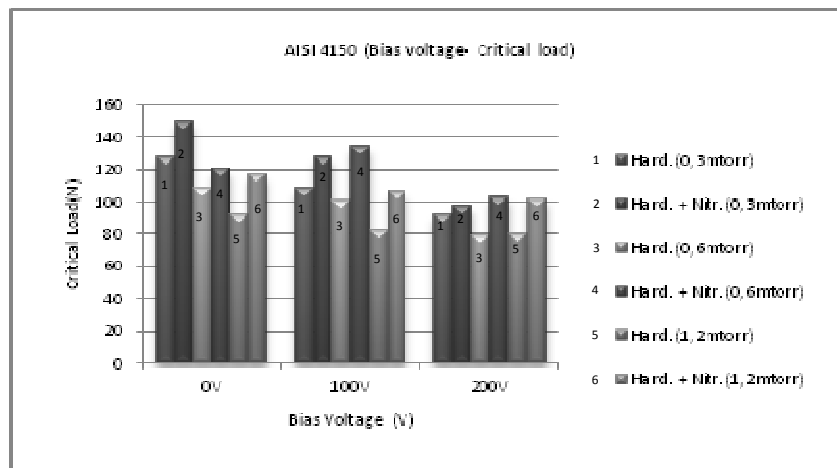

Figure 4.5. Result of scratch test of AISI 4150 base material according to different pressure values at different bias voltages.

4.1. Results of Wear Test

Wear tests for AISI 4150 samples with TiAlN coatings were performed at room temperature (20-22 °C) and in dry conditions using the following parameters; 15 N normal loads, 10 mm/min sliding rate and sliding distance of 2 mm. Determination of the number of cycles to 100 defined with pre-test and force of friction change should remain constant as a criterion. The L8 experimental design was used for evaluating wear tests. Wear rates were calculated by the formulation in equation 4.1. Where V_w is the volume of wear (mm^3), F_n is normal force (15 N) and a is the total sliding distance ($0.002 \text{ m} \times 100 \text{ cycles} = 0.2 \text{ m}$).

$$\text{Wear Rate} = \frac{\text{Wear Volume (mm}^3\text{)}}{\text{Contact Energy (Nm)}} = \frac{V_w}{F_n a} \quad (4.1)$$

According to the results of wear testing, it was found that TiAlN coating reduces the coefficient of friction in samples subjected to hardening applications. Hardened +Nitrided+TiAlN coated samples had a higher coefficient of friction (at 1.2 mtorr,-200V, $\mu=0.6-0.65$) as shown in Figure 4.6. The reason for this was the high surface

roughness of the nitrided base material with a column structure [16, 17]. It is very important for the surface of a coating to be as smooth as possible to reduce contact stress with the rough surface of the base material. It was determined that nitrided samples had a low wear rate despite having a high coefficient of friction and were followed by the hardened samples. The lowest wear rate achieved in the coating process using hardened + nitrided AISI 4150 steels was with a bias voltage of 0 V and pressure of 1.2 mtorr. This result was also proportional to the hardness of the samples.

The best results in terms of wear were found by considering the base materials, hardness, and strength and coating adhesion results by the depositing of TiAlN on the AISI 4150 material at a bias voltage of 0V and pressure of 1.2 mtorr, as shown in Figure 4.7. The coating thickness of the samples (Figure 4.1) directly affects wear resistance. The samples with a high coating thickness showed better wear resistance [18, 19]. The adhesion between the TiAlN and the hardened+nitrided samples, as seen in Figure 4.5, suggesting that the wear resistance was dominantly affected by adhesion, and load bearing capacity of the nitrided layer was great. Trace

images obtained from TiAlN coated samples and wear test results of abrasive wear sphere shown in Figure 4.8. Depending on the direction of wear is observed adhering on the edge sections (Figure 4.8 a-b) also on the abrasive wear sphere occurring of the wear region and adhered

coating particles (Figure 4.8c). Oxidation and breakage of the coating was observed on the edge section with increased of plastic deformation during the wear (Figure 4.8d).

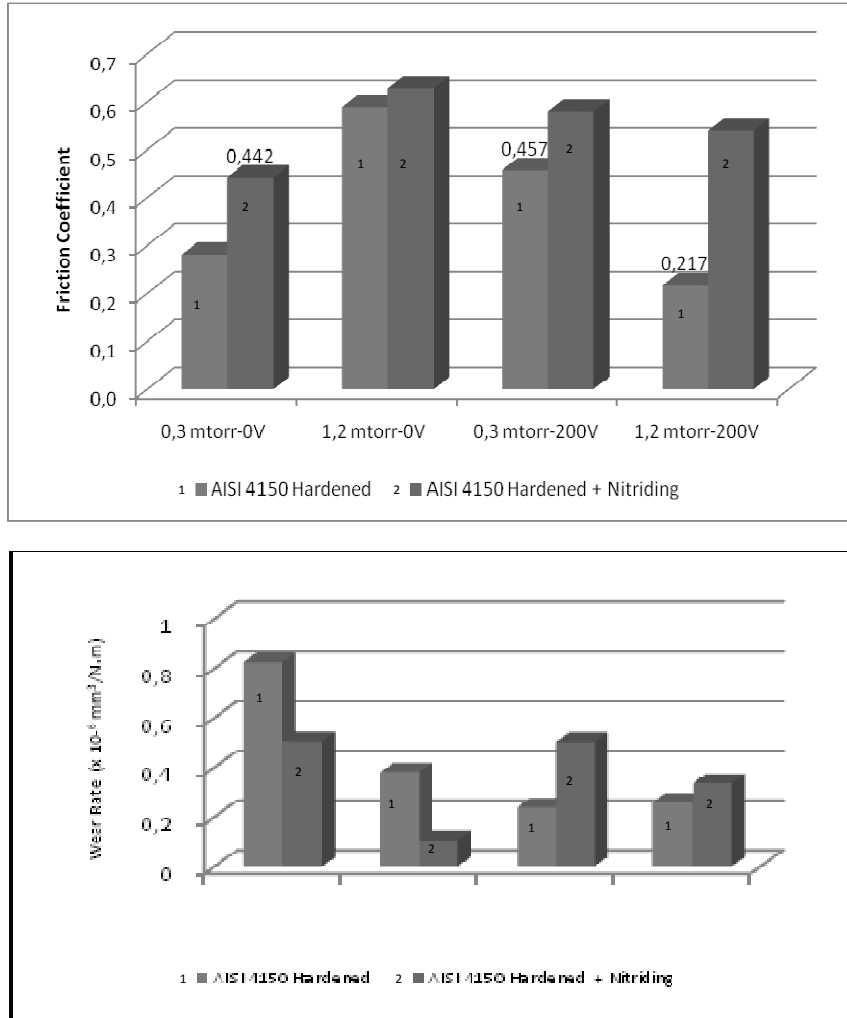

Figure 4.6-4.7. The friction coefficient values and wear rate obtained from wear test results for TiAlN-coated samples (cycles: 100).

In the wear tests, a three-factor two-level ($2^3=8$ runs) full factorial experimental design was applied. Three factors, involving in the bias voltage, nitrogen pressure and pretreatment type of the base material, were selected to characterize TiAlN coatings. For each factor, two levels were chosen to cover the experimental region.

MINITAB[®] Release 14 statistical software was used to analyze the experimental data in order to measure the effect of various factors and interactions on wear properties using “the bigger the better” situation. The factors and the values corresponding to their levels used in this study are listed in Table 4.1.

Table 4.1 The factors and the values corresponding to their levels

Factors		Levels	
		-1	+1
A	Bias voltage (-V)	0	200
B	N ₂ pressure (mtorr)	0.3	1.2
C	Pretreatment of the base material	a	b

a-Hardened b-nitrided+hardened

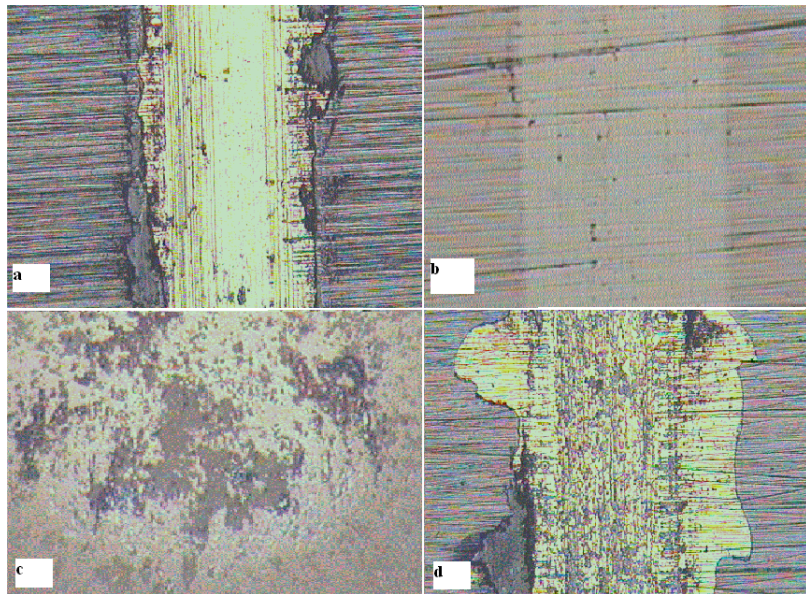

Figure 4.8. Trace images obtained from TiAlN coated samples and wear test results of abrasive wear sphere.

The normal probability plot of the effects, the pareto chart of the effects and the main effects plot for wear rates are given in Fig. 4.9 a and b, respectively. In general it was found that the effect values of the plotted L8-normal probability graphic are low for wear rate but it was determined that the most effective parameters for AISI 4150 were B (pressure of nitrogen), and then parameter A (bias voltage). Nitriding is more effective than hardening treatment for samples.

The wear resistance of the base material was improved by increasing the load carrying capacity of the pretreatment effect. The effect of the pretreatment differed according to the samples. Interaction of the bias voltage with the pretreatment of AISI 4150 steel was higher than nitrogen pressure, as shown in Figure 4.9b. In particular, the AC

and AB interactions (bias voltage - pretreatment and nitrogen pressure-bias voltage) were observed to be in the forefront. The lowest wear rate was achieved at a bias voltage of -200 V in the hardened base material or at a bias voltage of 0V and a pressure of 1.2 mtorr. These results show that taking into account the effect of hardening, bias voltage should be chosen according to the appropriate process. However, according to the results obtained for the TiAlN coating deposited on the AISI 4150 base material for bias voltage it was understood that the wear rates of the coating were lower in nitrided samples and at a high nitrogen pressure (1.2 mtorr). As a result, it was found that the hardening + nitriding process of AISI 4150 with high nitrogen pressure(1.2 mtorr) gave the best wear resistance.

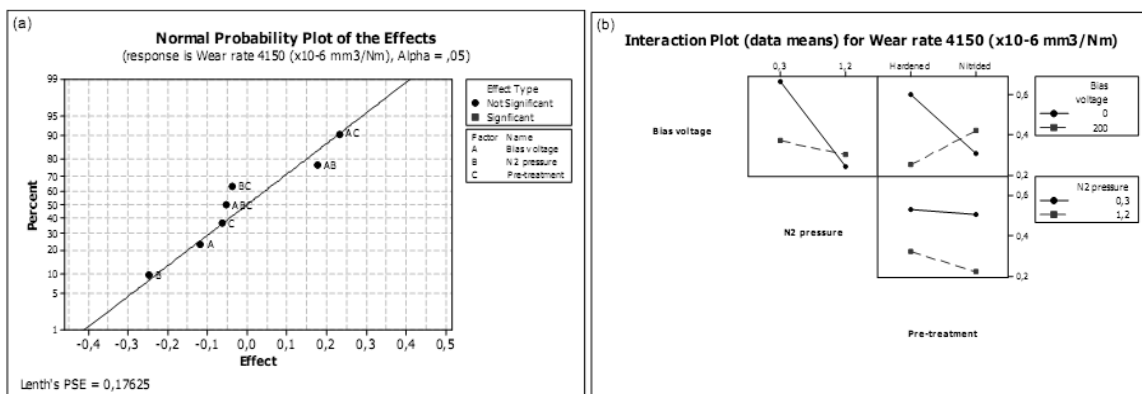

Figure 4.9. Obtained with Minitab- 14 program, the critical loads for a) L8-normal probability graph, b) interaction charts (AISI 4150)

Hardness, thickness of coating and roughness were tested on silicon chips. It was determined that on samples deposited of more Al % ratio has lower nano-hardness. Aluminum Nitride has grain and hexagonal lattice structure because of increasing ratio of Al % is increased brittleness of the coating.

It was observed that bias voltage did not significantly change the value of the surface roughness. However the roughness of nitrided samples was higher than that of the hardened samples. Also, nitriding caused an increase in the critical load value. The material surface strength was increased by increased hardness thereby base material surface deformation can be avoided even with increased

load. The adhesion strength of samples increased with increasing roughness in the nitrided samples which also increased the critical load value. Bias voltage did not have a clear effect on the adhesion strength of the coating deposited on the AISI 4150 base material. The adhesion resistance of the samples is important for the hardness of the base material and coating thickness ($> 2 \mu\text{m}$). Coating thickness was observed to be an effective parameter for wear rate. Despite the friction coefficient increase with increasing roughness in the nitrided samples, wear performance was increasingly influenced by the increase in surface hardness. The wear properties of the coating deposited on the samples were affected by the interaction of the surface properties, bias voltage and pressure.

5. CONCLUSIONS

Developing technology and difficulties of competitiveness have forced the automotive industry to focus on the use or development of longer life materials. Environmental impacts, production costs, aesthetic factors etc. should be kept in mind during the design process. Long life and performance is especially important for engine parts and tools used in the manufacture of these parts. In this study, the AISI 4150 steel material was selected because of its use in engine parts. TiAlN coating was deposited on AISI 4150 base material at bias voltages of 0V, -100V, -200 V and nitrogen pressures of 0.3 mtorr, 0.6 mtorr, and 1.2 mtorr. Wear tests were performed at room temperature and in dry conditions. The effect of deposition parameters on wear rate were investigated using $L_8(2^3)$ experimental design. The optimum process parameters were determined by the statistical evaluation of the data. It was found that the hardening + nitriding process of AISI 4150 with high nitrogen pressure (1.2 mtorr) gave the best wear resistance which resulted in a decreased coefficient of friction and a reduction in wear rates.

ACKNOWLEDGEMENTS

The authors would like to thank the Scientific Research Units at Erciyes University for their contribution and support (Project No: FBY 09-854).

CONFLICT OF INTEREST

No conflict of interest is declared by the authors.

REFERENCES

- [1] Danişman Ş., Savaş S., Işık G., Bendeş O., Özbekler A., “Uçak Türbin Kanatlarında Kullanılan Erozyon ve Korozyon Dirençli Sert Seramik Kaplamalar”, HASEM’08, *Kayseri VIII. Havacılık Sempozyumu, Erciyes Üniv.*, Kayseri, 41-47, (2008).
- [2] Vetter J., Barbezat G., Crummenauer J., Avissar J., “Surface Treatment Selections for Automotive Applications”, *Surface and Coating Technology*, 200, 1962-1968, (2005).
- [3] Ceschini L., Lanzoni E., Martini C., Prandstraller D. and Sambogna G., “Comparison of Dry Sliding Friction and Wear of Ti6Al4V Alloy Treated by Plasma Electrolytic Oxidation and PVD Coating”, *Wear*, Vol. 264, pp. 86-95, (2008).
- [4] Gahlin R., Larsson M., Hedenqvist P., “ME-C:H coatings in motor vehicles”, *Wear*, 249,302-309,(2001)
- [5] Zhuo S., Peijun Z., Leheng Z., Xinfu X., Aimin H., Wenquan Z., “Muti-Layer Compound Coating on Cast Iron Piston Ring by Multi-Arc and Magnetron Sputtering Ion-Compound Plating Technique”, *Surface and Coatings Technology*, 131, 422-427, (2000).
- [6] Agarwal K.A., Garg A., Srivastava D.K., Shukla M. K., “Comparative wear performance of titanium based coatings for automotive applications using exhaust gas recirculation”, *Surface and Coatings Techn.*, 201,6182-6188,(2007).
- [7] Mezlini S., et al., “Effect of Indenter Geometry and Relationship Between Abrasive Wear and Hardness in Early Stage of Repetitive Sliding”, *Wear*, 260, 412-421, (2006).
- [8] Efeoğlu I., “Co-sputtered Mo:S:C:Ti:B Based Coating for Tribological Applications”, *Surface and Coatings Technology*, 200, 1724-1730, (2005).
- [9] Lau K.H., Li K.Y., “Correlation between Adhesion and Wear Behaviour of Commercial Carbon Based Coatings”, *Tribology International*, 39, 115-123, (2006).
- [10] Wuhler R., Yeung W.Y., “Effect of Target-Substrate Working Distance on Magnetron Sputter Deposition of Nanostructured Titanium Aluminium Nitride Coatings”, *Scripta Materialia*, 49, 199-205, (2003).
- [11] Wuhler R., Kim S., Yeung W.Y., “Effect of Nitrogen Partial Pressure on the Surface Morphology and Properties of Reactive DC Magnetron Sputtered Titanium Aluminium Nitride Coatings”, *Scripta Materialia*, 37, 1163-1168, (1997).
- [12] Tanaka Y., Gür T.M., Kelly M., Hagstrom S.B., Ikeda T., “Structure and properties of (Ti1-xAlx)N films prepared by reactive sputtering” *Thin Solid Films*, 228, 1-2, 238-241 , (1993).
- [13] Håkansson G., Sundgren J.E., McIntyre D., Greene J.E., Münz W.D., “Microstructure and physical properties of polycrystalline metastable Ti0.5Al0.5N alloys grown by d.c. magnetron sputter deposition”, *Thin Solid Films*, 153, 1-3, 55-65, (1987).
- [14] Barshilia H.C., Yogesh K., Rajam K.S. “Deposition of TiAlN coatings using reactive bipolar-pulsed direct current unbalanced magnetron sputtering”, *Vacuum*, 83,427-434, (2009).
- [15] Fossati A. , Borgioli F., Galvanetto E., Bacci T., “Glow-discharge nitriding of AISI 316L austenitic stainless steel: influence of treatment time”, *Surface and Coatings Tech.*, 200, Issue 11, 3511-3517, (2006).
- [16] Yetim A.F, “Biyomalzeme Olarak Kullanılan AISI316L Paslanmaz Çelik ve Ti6Al4V Alaşımlarının

Plazma ile Nitrürleme Davranışı,Ti-DLC İnce Film Kaplama İle Karşılaştırılması”, Phd Thesis, *Atatürk University Graduate School of Naturel and Applied Sciences*, 62-63 (2009).

[17] Luo K., Hovsepian P.Eh., Lewis D.B., Münz W.D., Kok Y.N., Kokrem et al., “Tribological properties of unbalanced magnetron sputtered nano-scale multilayer coatings TiAlN/VN and TiAlCrYN deposited on plasma nitrided steels”, *Surface and Coatings Technology*, 193, 39-45 (2005).

[18] De Las Heras E., Egidio DA., Corengia P, Gonzalez-Santamaria D., Garcia-Luis A.,Brizuela M.,”Duplex surface treatment of an AISI 316L stainless steel; microstructure and tribological behavior”. *Surf Coat Technol*, 202, 2945–54, (2008).

[19] Wolfgang T.,Vogli E.,Momeni S., “Mechanical and tribological properties of Ti/TiAlN duplex coatings on high and low alloy tool steels”, *Vacuum*, 84,387-392,(2010).