



# An Expert System Design and Application for Hydroponics Greenhouse Systems

Ismail ŞAHİN<sup>1</sup>, M.Hanefi CALP<sup>1,\*</sup>, Atacan ÖZKAN

<sup>1</sup>*Gazi University, Institute of Informatics, Ankara, Turkey*

*Received: 20.02.2013 Revised: 11.02.2014 Accepted: 17.02.2014*

---

## ABSTRACT

In this study, the hydroponics subject is briefly discussed and developed an expert system on the subject. Expert system, the process of upbringing of plants produced in the hydroponics systems has controlled. The system is able to determine to the values of input parameters by using output parameters entered by user. The input parameters preparing the optimum growing environment for plants by controlling the process of plant breeding. Thus, removal of the optimum level of efficiency in activities the hydroponics and minimize of the labor force and cost will be spent in the process of plant growth is aimed.

**Key Words:** *Expert System, Hydroponics, Greenhouse, Automation*

---

## 1. INTRODUCTION

Although hydroponics is a very young science, short period of time, it has been adapted to many situations, from outdoor field culture and indoor greenhouse culture to grow fresh vegetables [1-4]. The aim of hydroponics is to provide the development of plants by the help of nutrition solution, to meet the plants nutrition and water demand without causing stress and to do so in the most economic means possible [5-7].

Hydroponics is the realization of all types of agricultural production in stagnant or effusive nutrition solution, in the vapour of solution or solid raising environments which are enriched by nutrition solution. The use of hydroponic culture has a number of advantages for physiological, biochemical and molecular studies such as allows for easy observation and measurement of root

growth and morphology throughout its life cycle [8-10]. Soiless agriculture is also superior in that problems such as soil exhaustion, diseases resulting from the soil or the existence of harmful substances in the soil are non existent and it can control development of the plant by inspecting the relationship between the fertilizer and water as well as terminating the factors that cause a decrease in quality resulting from the soil and increasing efficiency [11]. At the same time, hydroponics systems are considered environment-friendly, because they eliminate the use of methyl bromide and other toxic chemicals to sterilize the soil, and reduce the contamination of groundwater due to fertilizer residues by collecting and recycling the fertigation effluents [12-13]. Hydroponics depends on giving the amount of water and nutritional elements that are necessary for the

---

\*Corresponding author, e-mail: mhcalp@gazi.edu.tr

development of the plant and it is classified into two as environment and water culture. In environment culture, plants are raised in organic and inorganic environments and irrigation nutrition solution bears additives. On the other hand, in water culture, the plants are being raised in water which contains nutrition elements [5-7].

For plant production in hydroponics, growers use water sources with different origins, such as surfacewater (lakes, natural and artificial ponds), groundwater (wells), municipal tapwater, rainwater and mixtures of these. Water quality depends mainly on the source that is used. As rainwater has low ionic strength and usually low microorganism and algal densities, it conforms to water quality guidelines and is often better than other sources [15-16]. In today's world, there are hydroponic greenhouses that are capital intensive, involve sophisticated instrumentation and built with controls to optimise internal climate and the delivery of water and nutrients to grow plants [9,17-18]. The greenhouse systems that use hydroponics are considered to be superior to field production systems in terms of water and nutrient use efficiencies [1,19]. Lately, one of the most important reasons why hydroponics is spreading quickly in greenhouses is the problems resulting from the soil.

In greenhouse production via hydroponics, providing the appropriate climatic conditions is attained through artificial mechanisms. This situation results in the system's being more complicated compared to agricultural production done in open environment. All factors such as humidity rate and temperature, direction and speed of the wind, the intensity of light, carbon dioxide, sun light, evaporation, soil temperature and the like interact with each other [20]. As a result, it is quite difficult to control all these factors and sustain the targeted efficiency. In order to provide this, it is necessary to use automation systems. In today's world, many automation systems have been developed for hydroponics. These techniques vary according to economic adequacy, the supply of the material to be used and the types of plants [21].

In the related literature on hydroponics greenhouse production expert system applications are nonexistent. In this field most, studies have mostly focused on the usage of expert systems in greenhouse plant production. Among these studies the one that Fynn has conducted has dealt with greenhouse production and the control of the environment [22]. Another study conducted by Chen and Li, on the other hand, has focused on the application of an expert system aiming at the management of greenhouse production and the diagnosis and prevention of disease [23]. Similarly, Hu and his friends have developed an expert system for greenhouse management based on real time environment control [24].

In this study, an expert system based automation system that was developed for the effective and efficient control of hydroponics greenhouse systems will be introduced. By the expert system that was constructed by making use of the knowledge and experience of the experts in the field, the aim has been to minimize the work force used in the process of hydroponics, the total amount of time spent in agricultural process and human based errors. In

the second part of the study, the control of hydroponics greenhouse plant production by means of automation systems, and in the third part, the structure and operation of the developed expert system will be analyzed. In the final part of the study, the results of the study will be scrutinized and suggestions for future studies will be made.

## 2. THE CONTROL OF HYDROPONICS GREENHOUSE PRODUCTION THROUGH AUTOMATION SYSTEMS

The efficiency of the hydroponics-based system greatly depends on its design and the way the water and nutrient applications are managed [9]. Greenhouses do not have generally the precision control of internal climate and monitoring of water and nutrient parameters. Thus, the regulation through automation of product growing medium in hydroponics systems is important.

Especially, the temperature and humidity of the interiors of the greenhouse are not checked regularly, resulting in unwanted situations. The studies conducted have revealed that in order to plan and realize an automation system specially designed for greenhouses, it is primarily necessary to have enough knowledge on greenhouse plant production [20].

Most of the greenhouse plant growers do not use any automation systems. Consequently, it is neither possible to economize from time and work force nor is it possible to gain high quality products. In order to minimize all of these drawbacks, it is crucial to use automation systems. Automation systems allows to be used extensively information and control systems to minimize the human contribution in business and processes. Due to the fact that automation systems develop as a result of long research periods and through experience, they are expensive in terms of instalment costs. Similarly, greenhouse automation systems are not frequently used in the agriculture sector due to the high installment costs. Moreover, previously, when the systems in question required a computer based operation, qualified persons that can use these systems was a requirement. However, in today's world, both the fact that computer usage has become user-friendly and widespread and the fact that greenhouses can meet the installment costs of the automation in no time, among other factors, has resulted in the spread of such systems. It is unavoidable in terms of time and cost to use technologies that we use in every aspect of our daily lives in agriculture as well. In today's world, where technology develops at a fast pace, technological developments in the field of agriculture increase at a high rate as well. This progress will accelerate even further the spread of the use of computerized automation systems. For example, by the realization of storage and evaluation of data in a computer, the proceedings in question will be conducted more efficiently [25].

The automation systems used in greenhouses can be analyzed in two sections; namely, climate control and the automation of irrigation-fertilization. These systems cover expert systems that generally involve backward-feeding or forward-feeding methods. In backward-

feeding systems, after the variable is perceived, the control system is activated while in forward-feeding systems the tendency of change of the variable is predicted initially and after that the control system reacts to the relevant tendency [20,26-27]. All these processes

are conducted by a computer unit which is the brain of the automation where the relevant programmes are loaded. Figure 1 explicitly depicts the computer unit and other surrounding units that control the automation systems.

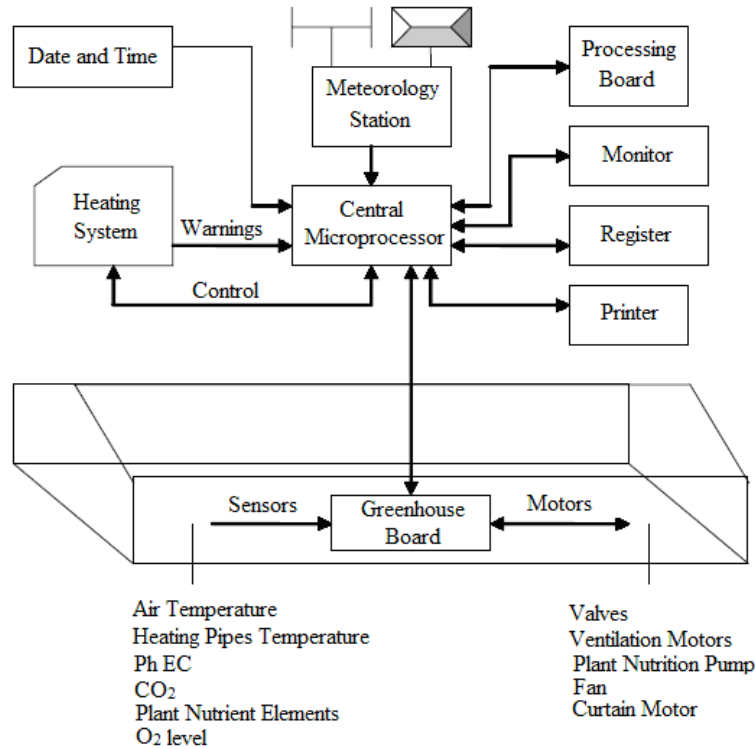

Figure 1. The computer unit and peripherals that control automation systems in a greenhouse [20]

### 3. THE STRUCTURE OF DEVELOPED EXPERT SYSTEM

The basic idea behind expert system (ES) is simply that expertise, which is the vast body of task-specific knowledge, is transferred from a human to a computer. This knowledge is then stored in the computer and users call upon the computer for specific advice as needed [29-31]. In other words expert systems require containing the knowledge from expert for a specific problem domain in order to make inference and decisions [23]. The computer can make inferences and arrive at a specific conclusion using this knowledge [28,32].

The expert system developed within the borders of this study is one that makes it possible to control the growth period of plants in hydroponics greenhouse systems. The expert system has been named as “Hydroponics Expert

System (HES)”. The system is able to define the values that belong to the input parameters by using the output parameters that are used by the user. The input parameters, on the other hand, by controlling the plant growth process, prepare the optimum growth environment for the plants. The software that is developed operates in an operating system that is Windows 2003 or above. Moreover, NET framework 3.5 should previously be uploaded to the computer that is going to be used for this purpose.

#### 3.1. User Interface

User interface is the graphic interface that provides the communication between the user and the programme. By using this unit, the user can control the knowledge base of the expert system, can enter data and can realization operations such as rule add or delete. By means of the interface depicted in Figure 2, it is possible to enter data and control the system.

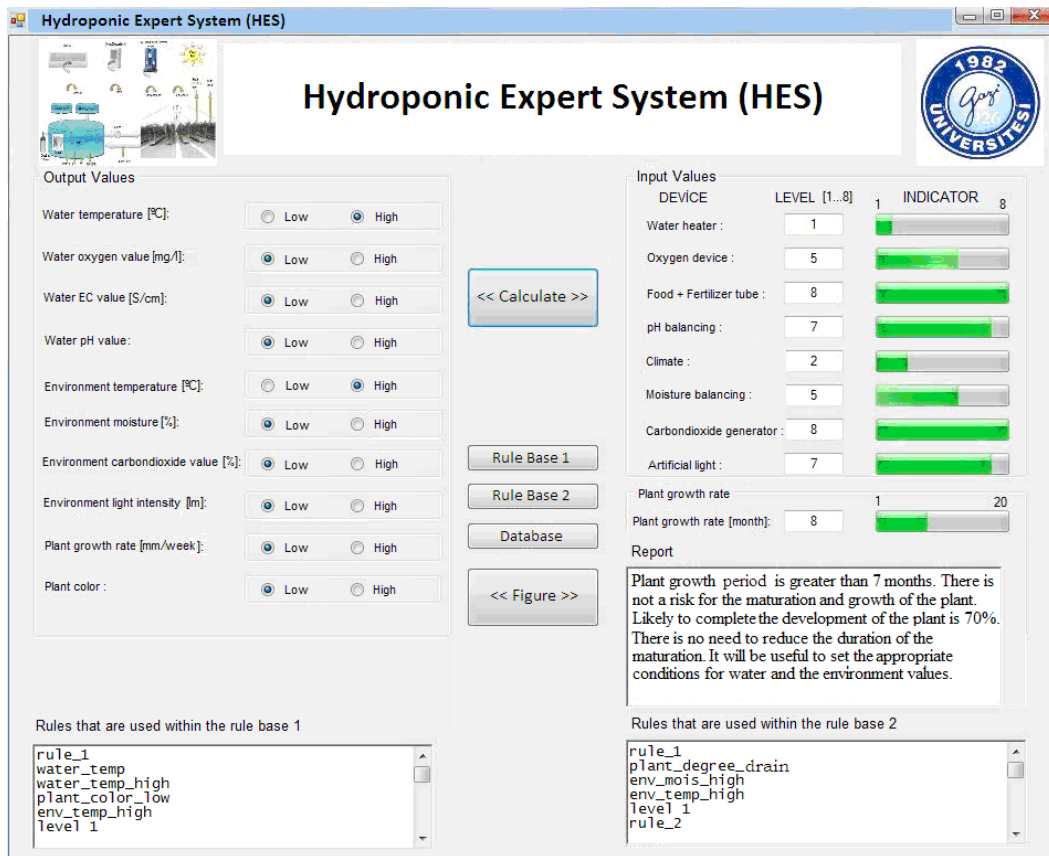

Figure 2. User interface

In the developed greenhouse system, input parameters are produced by evaluating the data attained from the output parameters. Output parameters have been determined as a result of the research on the related literature and selected from the parameters that have frequently been used in these studies, and by taking the opinion of experts in hydroponics [5,26-27,33]. Some of these parameters such as carbon dioxide device, moisture device and artificial light device have not been used due to the high prices. But, in this study, all parameters were taken in consideration in order to create controlled environment exactly. The general structure of hydroponics greenhouse system, which has been developed, is displayed in Figure 3.

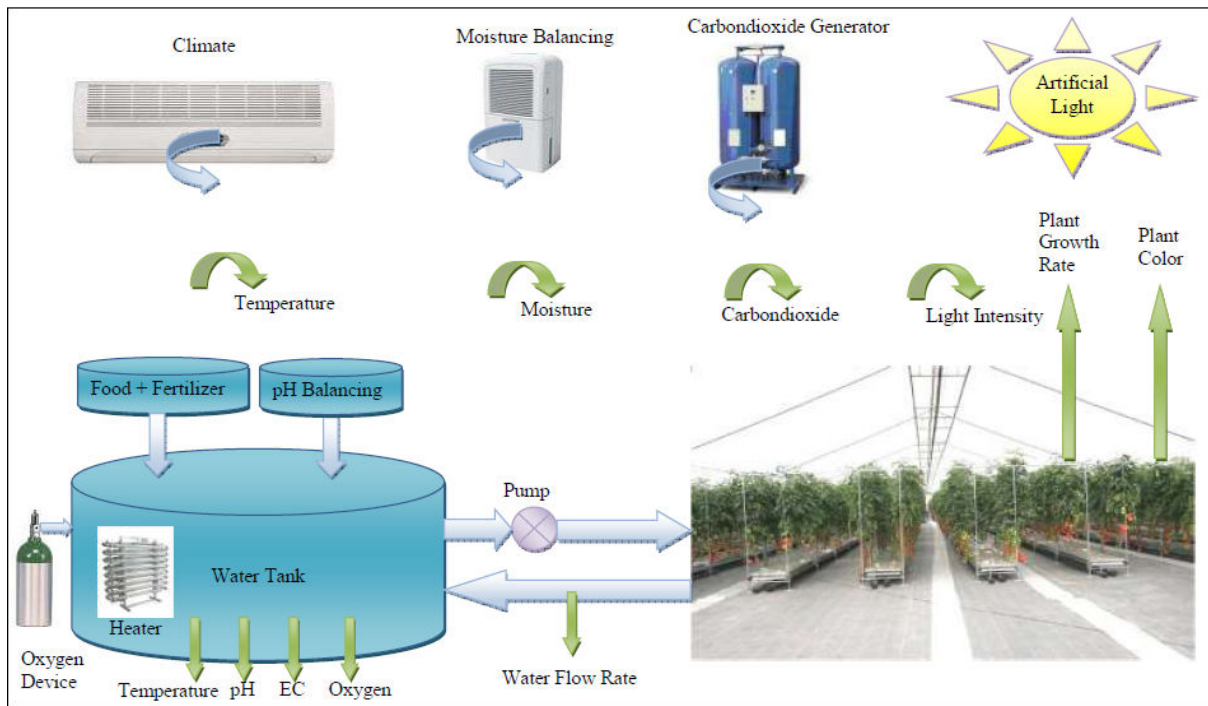

Figure 3. The general structure of the developed hydroponics greenhouse system

### 3.2. HES Knowledge Base

In an expert system, the knowledge base is made up of two main parts which are the database and the rule base. Knowledge base is continuously in a process of improvement [34]. On one hand, human experts would add new knowledge to knowledge base or modify the existing knowledge heuristics when new situations occur[35].

#### 3.2.1. Database

Data base is made up of real conditions that summarize the current situation of the problem and quality-value pairs [36]. A fact in the database specifies the value of some attribute for some object and has the form  $x$  is  $A$ , where  $x$  denotes a variable taking values in some universe  $X$  and  $A$  represents a subset set in  $X$  [37]. In the developed expert system, “text” files have been created in

order to store information. In the input screen, information gathered by means of the choices regarding the values of the output parameters are used to create the data that the system is going to use (Table 1). In figure 4, the screen image of the data base that was formed by means of the values attributed to the output parameters is displayed. Here “low” and “high” descriptions related to output parameters, quantitative values measured by means of devices such as sensor, detector and thermometer (carbondioxide, oxygen, moisture and temperature etc.) and other information received by expert knowledge (plant growth rate, plant colour etc.) are transformed into linguistic characterization. While making a decision, expert systems do not make use of quantitative data, but linguistic characterization. For this reason, such a transformation or description is necessary.

Table 1. The output and input parameters used in the greenhouse system

Order	Output Parameters	Input Parameters
1	Water temperature	Water heater
2	Water oxygen value	Oxygen device
3	Water EC value (Hardness of water)	Food + Fertilizer tube
4	Water pH value	pH balancing
5	Environment temperature	Climate
6	Environment moisture	Moisture balancing
7	Environment carbondioxide value	Carbondioxide generator
8	Environment light intensity	Artificial light
9	Plant growth rate	
10	Plant color	

```

water_temp_low
water_oxy_value_low
water_ec_value_low
water_ph_value_low
env_temp_low
env_mois_low
env_carb_value_low
env_light_int_low
plant_growth_rate_low
plant_color_low

```

Figure 4. A sample view from the database

### 3.2.2. Rulebase

HES uses output parameters with combinations and produces input parameters by using more than one data.

For example, the input parameter water heater can be adjusted by using output parameters such as water temperature, environment temperature and plant colour (Table 2).

Table 2. The relationship that make up output rule table

Order	Input Parameters	Relationship	Related Output Parameters
1	Water heater	~	Water temperature x Environment temperature x Plant color
2	Oxygen device	~	Water oxygen value x Water pH value x Water EC value
3	Food + Fertilizer tube	~	Water EC value x Water pH value x Plant growth rate
4	pH balancing	~	Water pH value x Water EC value x Plant color
5	Climate	~	Environment temperature x Environment moisture x Plant color
6	Moisture balancing	~	Environment moisture x Environment temperature x Plant color
7	Carbondioxide generator	~	Environment carbondioxide value x Environment temperature x Plant growth rate
8	Artificial light	~	Environment light intensity x Environment temperature x Plant growth rate

Moreover, by all of these output parameters level management, the total level grade can be attained and this can determine the development period of the plant. As a result, in this study, there are two rule bases. The first one is the rule base that constitutes the input parameters and

the second one is the rule base that determines the growth period of the plant. The rule bases are constructed by making use of the information used in Table 2 and Table 3.

Table 3. The relationship that make up the rule table for growth period of plant

Order	State	Relationship	Related Output Parameters
1	The degree of plant drain	~	Environment moisture x Environment temperature
2	The degree of plant nutrition	~	Water oxygen value x Water EC value
3	The degree of plant decay	~	Water temperature x Water pH value
4	The degree of plant photosynthesis	~	Environment light intensity x Environment carbondioxide value
5	The degree of plant growth	~	Plant color x Plant growth rate

For the first rule base, each output parameter can take two different values which are “low” and “high”. Therefore, for each input parameter,  $2 \times 2 \times 2 = 8$  different

situations are formed. In this way, the control values of the input devices can be attuned to 8 levels. As there are 8 input parameters, in all, rule base there are 64 rules (Figure 5).

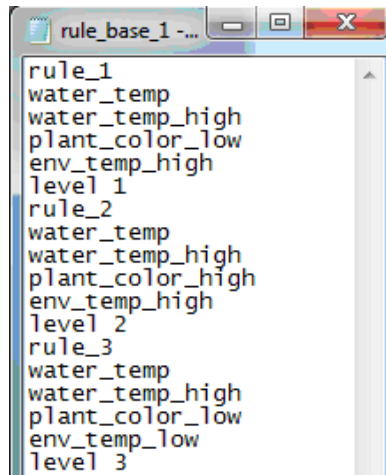

Figure 5. Rule base file

The sample rule table that determines the input parameters is demonstrated in Table 4.

Table 4. The examples from input parameters rule table.

Order	Input Parameters	Levels			Levels				
1	Water heater	Water temperature		Low		Water temperature		High	
				Low	High			Low	High
		Low		7	8	Low		3	4
		High		5	6	High		1	2
2	Oxygen device	Water oxygen value		Low		Water oxygen value		High	
				Low	High			Low	High
		Low		5	6	Low		1	2
		High		7	8	High		3	4
3	Food Fertilizer +	Water EC value		Low		Water EC value		High	
				Low	High			Low	High
		Low		8	6	Low		4	2
		High		7	5	High		3	1
4	pH balancing	Water pH value		Low		Water pH value		High	
				Low	High			Low	High
		Low		7	8	Low		3	4
		High		5	6	High		1	2

In the second rule base, each output parameter can take two different values as “low” and “high”. Therefore, for each plant condition parameter 2x2=4 different values are possible. As there are 5 plant condition parameters, in the second rule base there are 20 rules. The growth period of

the plant is determined by adding the values of plant drain degree, plant nutrition degree, plant deterioration degree, plant photosynthesis degree and plant growth degree. The rule table of this is displayed in Table 5.



Table 5. The plant growth period rule table

Order	State	Levels			
1	The degree of plant drain	Environment moisture		Low	High
		Environment temperature			
		Low	4	3	
2	The degree of plant nutrition	Water oxygen value		Low	High
		Water EC value			
		Low	1	2	
3	The degree of plant decay	Water temperature		Low	High
		Water pH value			
		Low	4	3	
4	The degree of plant photosynthesis	Environment light intensity		Low	High
		Environment carbondioxide value			
		Low	1	3	
5	The degree of plant growth	Plant color		Low	High
		Plant growth rate			
		Low	1	2	
		High	3	4	

The little of created rule base is displayed in Figure 6.

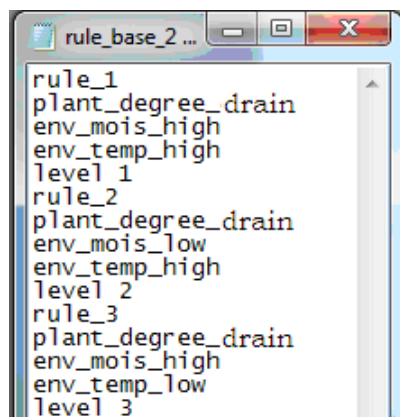

Figure 6. The rule base file is created for plant growth period

**3.3. Inference Engine**

Inference engine is where meaningful inferences are made by using the rules in the rules base [38]. Its function is to produce the results that the system needs by using the data in the knowledge base and by interpreting the rules. During the process of interpreting the knowledge base, inference engine makes use of two different methods. These are forward and backward sequences methods [39-41]. In this study, “forward sequence” which starts from the already known data and proceeds until the appropriate rule is found is used. Moreover, this method is based on meeting the demands of the current conditions.

The inference engine of the system works in the following manner; the user interface of the HES software (Figure 2) and the relevant output values taken from the greenhouse system and the sensors are interpreted and

translated into linguistic expressions such as low-high. For example, in the algorithm depicted in figure 7, these values are water temperature, plant colour and environment temperature. After the data that are collected by user choice are saved at the data base, inference engine finds the rule that matches the reality in the data base. When the system finds a rule that matches the related values in the rule base, it attributes this level value as the level value of the water heater. Having done that, it offers this value to the user in the form of sign and writing. The very same scenario is used for all of the another output parameters and oxygen device, nutrition and the operating levels for fertilizer tube, pH balance, conditioner, moisture balance, carbon dioxide producer and artificial light are attuned, creating the appropriate conditions for the greenhouse system.

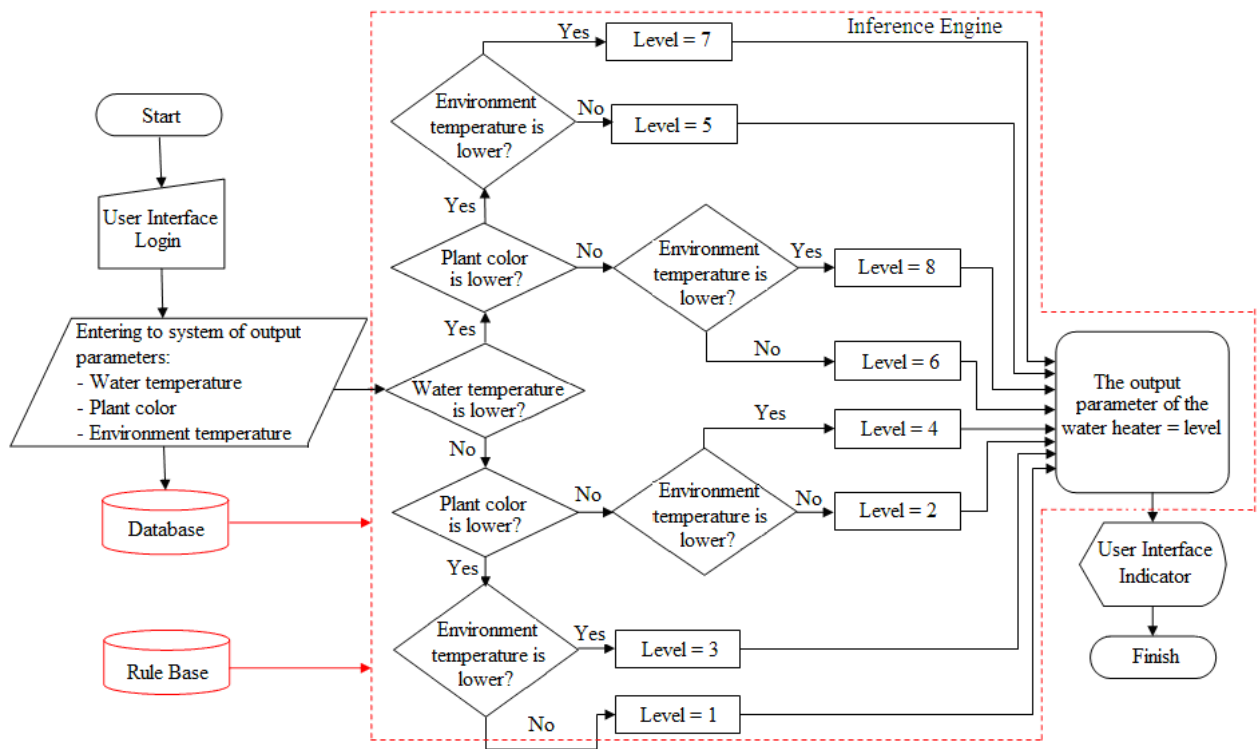

Figure 7. The working algorithm and inference engine according to water temperature, plant color and environment temperature

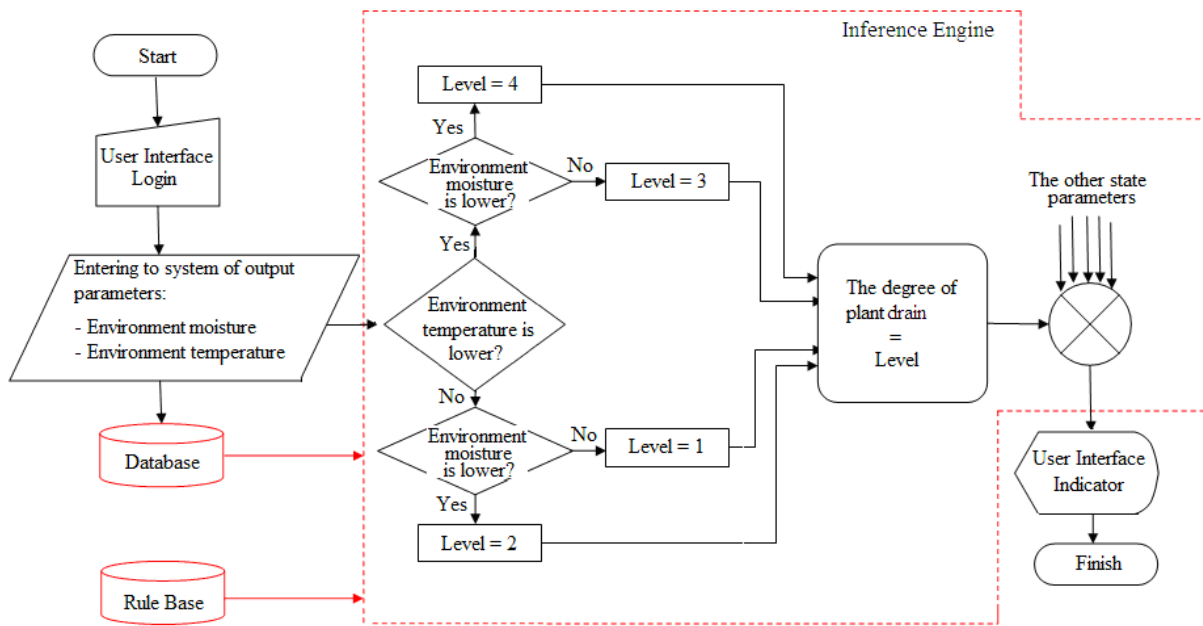

Figure 8. The working algorithm and inference engine of plant growth period according to environment moisture and environment temperature

Finally, certain level values are attained by using the plant condition data. The total of these values give information about the growth period of the plant. For example, the algorithm displayed in Figure 8 explains the system that appears in the first line of Figure 5. That is, the algorithm, adjusts the plant drain degree according to the environment moisture and temperature. The others are also detected as appropriate for this.

The growth period of the plant is calculated by making use of the total level data collected from plant condition

data. Plant growth period is attained from the total of plant drain degree, plant nutrition degree, plant deterioration degree, plant photosynthesis degree and plant growth degree parameters (Eq. 1).

$$\text{Plant growth period} = \text{plant drain degree} + \text{plant nutrition degree} + \text{plant deterioration degree} + \text{plant photosynthesis degree} + \text{plant growth degree} \quad (\text{Eq. 1})$$

After all these processes are completed, reports are produced by the system, based on the plant growth period as displayed in Table 6.

Table 6. Plant growth period rapors

State	Plant growth period <=7 months	Plant growth period >7 months	Plant growth period >12 months	Plant growth period >16 months
State	Plant growth period is smaller than 7 months.	Plant growth period is greater than 7 months.	Plant growth period is greater than 12 months.	Plant growth period is greater than 16 months.
Risk	There is not a risk for the maturation and growth of the plant.	There is not a risk for the maturation and growth of the plant.	There is not a big risk for the maturation and growth of the plant.	Maturation and growth of the plant is at risk.
Probability	Likely to complete the development of the plant is 90%.	Likely to complete the development of the plant is 70%.	Likely to complete the development of the plant is 50%.	Likely to complete the development of the plant is 20%.
Measure	There is no need to reduce the duration of the maturation.	There is no need to reduce the duration of the maturation.	There is need to reduce the duration of the maturation.	There is need to reduce the duration of the maturation.
Application	There is no need to alter the values of water and the environment.	It will be useful to set the appropriate conditions for water and the environment values.	The relevant input parameters must be set, water and environment values must be set to the appropriate conditions.	The relevant input parameters must be set, water and environment values must be set to the appropriate conditions.

3.4. Description Unit

An expert system should have the quality to report the work process. In other words, it should have the ability

to explain the inference it made by making use of the knowledge base. The developed expert system can present a report of the inference process to the user by means of the description unit (Figure 9).

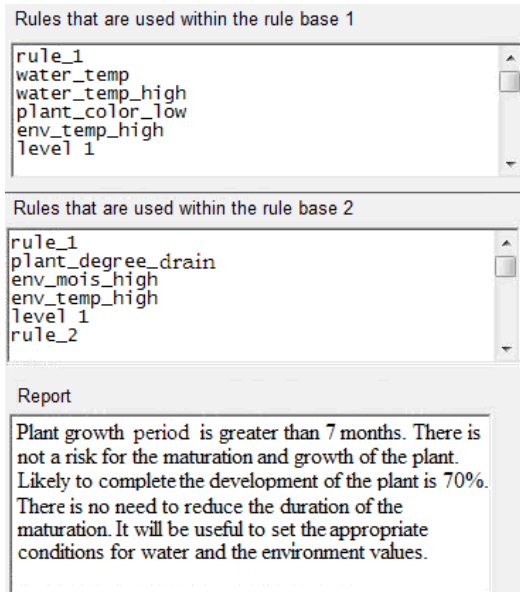

Figure 9. The rules used and a sample report output

#### 4. RESULT AND SUGGESTIONS

In this study, an expert system that aims at controlling of the growth periods of plants that are produced in hydroponics greenhouse systems has been developed. HES rule base has been constituted according to the input-output parameter relations. So as to provide a sample for the study, two levels have been applied. These levels have been prepared by taking into consideration the personal experience of experts and the information gathered from the related literature. The expert system that has been constructed can be used in greenhouses where there is no automation machinery by means of appropriate changes as well as in greenhouses that are yet to be set up. Also, it will be adaptable to renewals that will be done in the long run by made economic installment with both low cost and user friendly software.

It is important that the software that is developed for hydroponics greenhouse production can perceive all of the factors within the plant growth production period and thus, come up with the correct decisions. The expert system that has been developed in this study has made the decision process much faster and easier.

Future studies that will take this study as a reference should take the following into account as it will make a great contribution to the field.

- In this study, output parameters (temperature, and moisture, pH and oxygen values) that are composed of the values that are gathered from the greenhouse and outside environment entered the system manually. An application that can enter these values automatically to system can be developed.
- In the reporting stage by using mobile technologies it can be made possible to transfer the results to the user instantly.

#### CONFLICT OF INTEREST

The authors declare that they have no conflict of interest.

#### REFERENCES

- [1] Sheikh, B.A. (2006). Hydroponics: key to sustain agriculture in water stressed and urban environment. *Pak. J. Agric., Agril. Eng., Vet. Sci.* 22, 53–57.
- [2] Benton, J. J. (2004). Hydroponics. A practical guide for the soilless grower. 2nd Edition, *CRC Press*. pp. 35-150.
- [3] Marschner, H. (1995). Mineral nutrition of higher plants. Academic Press. London, *Abstract: Soil Sci.*, 168(1): 29-38.
- [4] Morgan, L, Peckenpaugh, D. (2004). Hydroponic Solutions, Voll: Hydroponic Growing Tips, *New Moon Publishing, Co.*, Covallis, OR.
- [5] Winsor, G., Schwarz, M. (1990). Soilless culture for horticultural crop production. Rome, P. 188 p.101.
- [6] Eltez, R.Z., Tüzel, Y., Tüzel, I.H., Gül, A., Demirelli, A. (2002). Effect of Continuous and Intermittent Solution Circulation on Yield, Fruit Quality and Water Consumption of Tomato Plants Grown in Nutrient Film Technique (NFT). *Ege University, Faculty of Agriculture-Electronic Journal*. 39(1):17-24.
- [7] Sevgican, A. (2003). Greenhouse Vegetable Cultivation. Vol II (Hydroponics). *Ege University, Agriculture Faculty Publications*. N:526. Bornova-Izmir. p.168.
- [8] Arteca, R. N and J. M. Arteca. (2000). A novel method for growing *Arabidopsis thaliana* plants hydroponically. *Physiol. Plant*, 108: 188–193.
- [9] Grewal, H.S., Maheshwari, B. and Parks, S.E. (2011). Water and nutrient use efficiency of a low-cost hydroponic greenhouse for a cucumber crop: An Australian case study, *Agricultural Water Management* 98, 841–846.
- [10] Parks, S.E., Worrall, R.J., Low, C.T., Jarvis, J.A. (2009). Initial efforts to improve the management of substrates in greenhouse vegetable production in Australia. *Acta Hort.* 819, 331–336.
- [11] Jones, Jr., J. B. (1983). A Guide For The Hydroponics and Soilless Culture Grower. ISBN: 0-917304-49-7. *Timber Pres.* Oregon.
- [12] Van Os, E.A., T.H. Gieling and M.N.A. Ruijs. (2001). Equipment for hydroponic installations. In: Savvas, D. and H.C. Passam (eds): Hydroponic production of vegetables and ornamentals. *Embryo Publications*, Athens, Greece, 103–141.
- [13] Ghehsareh, A. M., Khosravan, S. and Shahabi, A. A. (2011). The effect of different nutrient solutions on some growth indices of greenhouse cucumber in soilless culture?, *Journal of Plant Breeding and Crop Science* Vol. 3(12), pp. 321-326, 30 October.
- [14] Sonneveld, C., Wim, V. (2009). Plant Nutrition of Greenhouse Crops. *Springer*. p. 431.
- [15] Sonneveld, C., de Kreij, C., van der Wees, A. (1991). Normen voor waterkwaliteit in de glastuinbouw, No. 11, fifth ed., p. 23.
- [16] Schwarz, D., R. Grosch, W. Gross and S. Hoffmann-Hergartenc. (2005). Water quality assessment of different reservoir types in relation to nutrient solution use in hydroponics. *Agricultural Water Management* 71 (2005) 145–166
- [17] Hitchon, G.M., Szmids, R.A.K., Hall, D.A. (1991). A low-technology hydroponic crop production system based on expanded perlite. *Acta Hort.* 287, 431–434.
- [18] Schnitzler, W.H., Sharma, A.K., Gruda, N.S., Heuberger, H.T. (2004). A low-tech hydroponic

- system for bell pepper (*Capsicum Annuum* L.) production. *Acta Hort.* 644, 47–53.
- [19] Bradley, P., Marulanda, C. (2000). Simplified hydroponics to reduce global hunger. *Acta Hort.* 554, 289–295.
- [20] Kurklu, A. and Caglayan, N. (2005). A Study on the Development of Greenhouse Automation Systems. *Akdeniz University, Journal of the Agriculture Faculty.* 18(1), 25-34.
- [21] Resh, H. M. (1991). Hydroponics Food Production. *Woodbridge Press Publication.* California. P. 462.
- [22] Fynn, R.P., Bauerle, W.L. and Roller, W.L. (1994). Implementing a decision and expert system model for individual nutrient selection, *Agricultural Systems*, Vol. 44, No. 2, 125-142, 0308-521X.
- [23] Chen, Q.Y. and Li, H. (2001). Study on the expert system of cucumber culture management in greenhouse. *Transactions of the CSAE.* Vol. 17, No. 6, 142-146, 1002-6819.
- [24] Hu, Y.G.; Li, P.P.; Zhang, X.L.; Wang, J.Z.; Chen, L.F. and Liu, W.H. (2007). Integration of an environment information acquisition system with a greenhouse management expert system. *New Zealand Journal of Agricultural Research.* Vol. 50, No. 5, 855-860, 0028-8233.
- [25] Gilreath, J. (1985). Description of a Basic Program For Data Collection Using a Portable Microcomputer. *American Society For Horticultural Science.* Apr. s.301.
- [26] Sener, A. (1990). Freeze-Cold Warning and Automatic Heating in Greenhouses, Extreme Hot Warning and Automatic Ventilation Cooling System. Master's Thesis. *Yüzüncü Yıl University Institute of Science.* Van.
- [27] Durmaz, N. (1994). A Study on gradual and automatic opening and closing of ventilation covers in greenhouses. Master's Thesis, *Akdeniz University, Institute of Science,* Antalya.
- [28] Liao, S.H. (2005). Expert system methodologies and applications-a decade review from 1995 to 2004. *Expert Systems with Applications*, 28,1, 93-103.
- [29] Turban, E., and Aronson, J. E. (2001). Decision support systems and intelligent systems, sixth Edition (6th ed). Hong Kong: *Prentice International Hall.*
- [30] Sahin, I. 2008. Solid model reconstruction from 2D projections using expert system, Doctoral Thesis. *Gazi University, Institute of Science.*
- [31] Nabiyev, V.V., (2005). Artificial Intelligence. *Seckin Publishing,* Ankara, 445.
- [32] Chen, Y., Hsu, C.Y., Liu, L., Yang, S. (2012). Constructing a nutrition diagnosis expert system, *Expert Systems with Applications*, 39, 2, 2132 - 2156.
- [33] Medsker, L., Leibowitz, J. (1994). Design and development of expert systems and neural Networks. *Macmillan,* Newyork, p.48-60.
- [34] Ciger, M. (2010). Computer Controlled, Internet-Aided Greenhouse Automation, Master's Thesis, *Cukurova University, Institute of Science, Department of Agricultural Machinery,* Adana.
- [35] Huang, Q. M., Li, X. X., and Qian, Y. (2001). A fault diagnosis expert system based on fault tree analysis for lubricating de-waxing process. *Computers and Applied Chemistry*, 18, 129–133.
- [36] Qian, Y., Zheng, M., Li, X., Lin, L. (2005). Implementation of knowledge maintenance Modules in an expert system for fault diagnosis of chemical process operation, *Expert Systems With Application*, 28, p.249-257.
- [37] Basak, H., Sahin, I., Gulen, M. (2008). The risk management model based on expert system for preventing unmanned air vehicle accidents, , Vol 11(3), 187-200.
- [38] Yen, V. C. (1999). Rule selections in fuzzy expert systems, *Expert Systems with Applications* 16, 79–84
- [39] Sahin, I., Calp, M. H., Akca, Ö. (2011). An Expert System Approach for Evaluation of Credibility Score. *Journal of Polytechnic.* 14 ( 1), 79-83.
- [40] Allahverdi, N. (2002). Expert Systems: Implementation of an Artificial Intelligence. (4th ed.). Istanbul. *Atlas Publishing.* 16-20.
- [41] Calp, M.H. (2011). Object Oriented Software Testing and Implementation of Expert Modul that Evaluating The Metric Suite. Master's Thesis, *Gazi University, Institute of Informatics,* Ankara.