



# Time-delay AVR System Analysis Using PSO-based PID Controller

Ercan Köse<sup>1\*</sup>, Serdar Coşkun<sup>2</sup>

<sup>1</sup> Tarsus University, Faculty of Engineering, Department of Electrical-Electronics Engineering, Tarsus, Mersin, Türkiye (ORCID: 0000-0001-9814-6339)

<sup>2</sup> Tarsus University, Faculty of Engineering, Department of Mechanical Engineering, Tarsus, Mersin, Türkiye (ORCID: 0000-0002-7080-0000)

(First received 25 February 2020 and in final form 13 April 2020)

(DOI: 10.31590/ejosat.717872)

**ATIF/REFERENCE:** Köse, E. & Coşkun, S. (2020). Time-delay AVR System Analysis Using PSO-based PID Controller. *European Journal of Science and Technology*, (18), 981-991.

## Abstract

In this study, a Particle Swarm Optimization (PSO) algorithm-based Proportional-Integral-Derivative (PID) controller is proposed for the Automatic Voltage Regulator (AVR) system terminal tracking problem in the existence of time-delay and varying loads. AVR is a commonly used electronic device for maintaining generator output terminal voltage at a given reference under time-delays and varying load thus introduces a challenging electrical system problem. Time-delays exist in many real-world systems due to the lags in transmission and transport, in general, they have a negative effect on the stability and control design. For analysis, the time delay in is approximated by Padé approximation leading to the so-called nonminimum phase system. A nonminimum phase system represents the difficulty of controlling due to its zeroes in the right half side of the s-plane. To this aim, we utilize a PID controller, its design and application widely studied in real-time systems, thus it is a suitable selection for the AVR system. The optimal controller gains, namely, proportional  $K_p$ , integral  $K_i$ , and derivative  $K_d$  are found with the proposed PSO algorithm based on a commonly used error minimization objective function. The PSO-based optimal PID controller's performance is analyzed with several methods including root locus, bode analysis, robustness, and disturbance rejection. It is demonstrated that the proposed PID controller improves the reference terminal voltage tracking performance of the AVR system. According to the obtained results, it has been revealed that the proposed PSO-based PID controller improves tracking properties under time-delay and load change thus it can be effectively used for synchronous generator automatic voltage regulator system terminal voltage stability.

**Keywords:** Automatic voltage regulator, Time-delay systems, Particle swarm optimization, Proportional-integral-derivative controller, Robustness

## PSO Tabanlı PID Denetimci kullanarak Zaman Gecikmeli OVR Sisteminin Analizi

### Öz

Bu çalışmada, zaman gecikmesi ve değişken yükler karşısında Otomatik Voltaj Regülatörü (OVR) sistemi terminal referans voltaj gerilimi takip problemi için bir Parçacık Sürüsü Optimizasyonu (PSO) algoritması tabanlı Oransal-İntegral-Türev (OİT) kontrolörü önerilmiştir. OVR, jeneratör çıkış terminal voltajını belirli bir referansta zaman gecikmeleri ve değişken yük altında tutmak için yaygın olarak kullanılan bir sistemdir, bundan dolayı zor bir elektriksel problemi ortaya çıkarır. Zaman gecikmeleri, iletim ve aktarmadaki gecikmelerden dolayı gerçek dünyadaki birçok sistemde bulunur, genel olarak kararlılık ve kontrol tasarımı üzerinde olumsuz bir etkiye sahiptirler. Analiz için, zaman gecikmesi, asgari olmayan faz sistemine yol açan Padé yaklaşımı ile yaklaşık olarak tahmin edilmektedir. Karmaşık faz sistemi, s-düzleminin sağ tarafında bulunan sıfırları nedeniyle kontrol güçlüğüne neden olur. Bu amaçla, OVR için gerçek zamanlı sistemlerde yaygın olarak kullanılan OİT kontrolör tercih edilmiştir. Optimal kontrolörün kazançları  $K_p$ ,  $K_i$  ve  $K_d$ , yaygın

\* Corresponding Author: Tarsus Üniversitesi, Mühendislik Fakültesi, Elektrik-Elektronik Mühendisliği Bölümü, Tarsus, Mersin, Türkiye, ORCID: 0000-0001-9814-6339, [ekose@tarsus.edu.tr](mailto:ekose@tarsus.edu.tr)

olarak kullanılan bir hata minimizasyon objektif fonksiyonuna dayanarak PSO algoritması ile optimize edilmiştir. PSO tabanlı en uygun katsayılı OİT denetleyicisinin performansı; kök yer eğrisi, bode analizi, sağlamlık ve bozucu karşısındaki dayanımı gibi çeşitli yöntemlerle analiz edilmiştir. Önerilen OİT denetleyicisinin OVR çıkış referans terminal gerilim izleme performansını iyileştirdiği görülmüştür. Elde edilen sonuçlara göre, önerilen PSO tabanlı OİT kontrolörünün zaman gecikmesi ve yük değişimi altında izleme özelliklerini geliştirdiği, böylece senkron jeneratör otomatik voltaj regülatörü sistemi terminal voltaj kararlılığı için etkili bir şekilde kullanılabileceği ortaya çıkmıştır.

**Anahtar Kelimeler:** Otomatik voltaj regülatörü, Zaman gecikmeli sistemler, Parçacık sürüsü optimizasyonu, Oransal-integral-türev denetimcisi, kararlılık

## 1. Introduction

Synchronous generators are used to generate electrical energy in power plants such as hydroelectric, wind energy, gas turbines, thermal, and nuclear. One of the most important problems in synchronous generators is keeping the terminal output voltage constant against load fluctuations. An electronic device called automatic voltage regulator to keep the terminal output voltage constant by changing the excitation voltage of synchronous generators. In other words, it provides voltage stability.

It requires that the AVR operates with a controller in order to keep the terminal output voltage at a reference value. When the literature is examined most of the studies utilize a proportional-integral-derivative controller to keep AVR output voltage at the desired value. These studies are about the optimal calculation of the PID controller's control variables coefficients. The results of the performance of different algorithms for optimality have been compared and examined. Some of these can be given as Bhati and Nitnawre (2012) genetic particle swarm Sahib (2015), differential evolution, Gozde and Taplamacioglu (2011) artificially bee colony, Bingul and Karahan (2018) cuckoo search, Ekinci et al. (2018), Whale, Ekinci et al (2019) Harris Hawks, dos Santos et al. (2019) chaotic optimization, Razmjoo et al. (2016) world cup competitions, and Ekinci and Hekimoğlu (2019) kidney-inspired algorithms.

The performance of different control methods as much as PID-based studies for the control of the AVR system are also investigated. Some of these important techniques applied to the AVR system are as follows. Ribeiro et al. (2015) sliding mode control, Elsis et al. (2019) the neural network predictive controller, Abegaz and Kueber (2019) Smart Control, Bhutto et al. (2019) Probabilistic Neural Network (PNN) based control, Ortiz-Quisbert et al. (2018) fractional-order model reference adaptive control are applied methods on AVR.

Kennedy and Eberhart developed a PSO algorithm based on the social behavior of bird and fish swarms in 1995. PSO should be considered as the analysis of a simplified social model based on the optimization of nonlinear functions Kennedy and Eberhart (1995). The PSO algorithm, based on swarm intelligence, reaches the target according to the purposeful optimization of the behavior of animals in situations such as food and safety. The PSO algorithm has been successfully applied to many different systems. We can some of these studies as follows.

Doctor et al. (2004) have demonstrated that PSO provides a good solution for target tracking systems of unmanned vehicles and mobile robots. Jeong et al. (2010) have been proposed a new Binary PSO approach inspired by quantum computing for the solution of unit commitment problems in power systems. Zhou et al. (2016) estimated the landslide displacement in the Three Gorges Reservoir, China by using the PSO algorithm. Godio and Santilano (2018) investigated the applicability of PSO to linear and nonlinear multi-parameter problems. They applied PSO using the observed geophysical data to produce a consistent Earth model such as electrical resistivity at depth. That is, they have demonstrated the applicability of PSO to solve the geophysical inverse problem. Madoliat et al. (2017) are represented gas networks transient simulation simplification with known inlet and outlet pressures. The actual values of pressures and flow rates calculated in different network nodes obtained using optimum inlet flow rates can be estimated by algorithms. Malmir et al. (2018) developed an adaptive neuro-fuzzy inference system based PSO algorithm for the asphalt deposition problem in the oil industries. 75 experimental data in the literature were used to test the training and success of the PSO algorithm. According to the graphical and statistical reports, their PSO algorithm has shown to have a feasible potential for investigating the effect on asphaltene inhibitors.

One of the important issues affecting the optimization algorithm is time-delays. Time-delays exist in many forms and systems such as temperature changes, information, energy, mass change, interconnected subsystems, sensors. Time delay is an important factor to be considered especially in complex structural systems. Because time lag may arise during the operation of these systems. When the time lag is not taken into consideration in theoretical and simulation studies of these systems, it is inevitable to encounter problems in practical application. Some studies that take into account time delay are as follows. Birs et al. (2018) investigated in detail the results of fractional order PI controller designed for second-degree dead time processes in an experiment. Narang et al. (2010) fractional-order system models based on a reference model with and without time delays, the adjustment of the PI controllers has introduced a relevant servo control strategy. In addition, an iterative optimization method by minimizing a quadratic cost function is proposed to find satisfactory adjustment parameters of the controller.

In this study, PSO optimization algorithm is proposed for the control of a PID based time-delay AVR system The dynamic system response of the time-delay AVR system is investigated with a PSO-based PID controller first time. The stability of this system, with and without a controller is studied and analysis is performed in both time and frequency domains. By designing a controller to the system, we show how the system behavior changes in detail. The obtained results are demonstrated that the proposed PSO tuned PID controller can be applied to the time-delayed AVR system.

## 2. Material and Method

### 2.1. PID Controller

PID controllers are having a robust structure and its proportional, integral, and derivative gains with a first-order filter is added, are given in Figure 1.

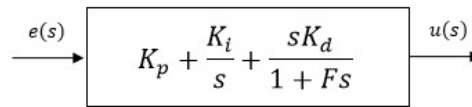

Figure 1. PID controller structure

$$G_{PID}(s) = \frac{u(s)}{e(s)} = K_p + \frac{K_i}{s} + \frac{sK_d}{1+Fs} \tag{1}$$

### 2.2 AVR System Modeling with time delay

AVR maintains of the synchronous generator at the reference voltage. A voltage sensor updates the output and it is compared with the reference voltage signal. Then the error is produced and transmitted to the amplifier. And, commonly, exciter signal transmission possesses a time-delay to control the generator field winding. With this in mind, AVR system components transfer functions are: amplifier transfer function  $G_a(s)$ , exciter transfer function  $G_e(s)$ , generator transfer function  $G_g(s)$ , Sensor transfer function  $G_s(s)$ , and Padé approximated time-delay transfer function  $G_d(s)$  are given in the sequel.

According to academic studies in the literature, constants of AVR subsystems are given below.  $10 \leq K_a \leq 40$ ,  $1.0 \leq K_e \leq 10$ ,  $0.7 \leq K_g \leq 1.0$ ,  $K_s = 1.0$ ,  $0.02 \leq T_a \leq 0.1$ ,  $0.5 \leq T_e \leq 1.0$ ,  $1.0 \leq T_g \leq 2.0$ ,  $0.001 \leq T_s \leq 0.06$ . The subsystem constants selected are as follows.  $K_a = 10$ ,  $K_e = 1.0$ ,  $K_g = 1.0$ ,  $K_s = 1.0$ ,  $T_a = 0.1$ ,  $T_e = 0.4$ ,  $T_g = 1.0$ , and  $T_s = 0.01$  Elsisi et al. (2019).

The time delay is approximated by Padé approximation, leading to a transfer function presentation so-called a nonminimum phase system. A nonminimum phase system represents the difficulty of controlling due to its zeroes in the complex right half-side of s-plane. For control design in this study, delay dynamics is approximated by a first of Padé approximation as follows,

$$e^{-t_s s} = \frac{\left(-\frac{t_s}{2}\right)s + 1}{\left(\frac{t_s}{2}\right)s + 1} \tag{2}$$

where,  $t_s$  is the time delay in the AVR model, chosen as  $t_s = 0.1$  secs. Since we address set-point tracking of terminal output voltage during steady-state, the magnitude and order of the Padé approximation are important. Higher order approximation can be used at the computational cost as well as making the system harder to analyze.

The amplifier, exciter, generator, sensor, and delay dynamics are shown in equation (3).

$$\left. \begin{aligned} G_a(s) &= \frac{K_a}{1 + sT_a} = \frac{10}{1 + 0.1s}, \\ G_e(s) &= \frac{K_e}{1 + sT_e} = \frac{1}{1 + 0.4s}, \\ G_g(s) &= \frac{K_g}{1 + sT_g} = \frac{1}{1 + 1s}, \\ G_s(s) &= \frac{K_s}{1 + sT_s} = \frac{1}{1 + 0.01s}, \\ G_d(s) &= \frac{\left(-\frac{t_s}{2}\right)s + 1}{\left(\frac{t_s}{2}\right)s + 1} = \frac{1 - 0.05s}{1 + 0.05s} \end{aligned} \right\} \tag{3}$$

The transfer function of AVR system without a controller is leading to equation (4)

$$G_{AVR}(s) = \frac{V_t(s)}{V_{ref}(s)} = \frac{G_a(s)G_e(s)G_g(s)G_d(s)}{1 + G_s(s)G_a(s)G_e(s)G_g(s)G_d(s)} = \frac{-0.005s^2 - 0.4s + 10}{2e - 05s^5 + 0.00267s^4 + 0.07315s^3 + 0.6305s^2 + 1.06s + 11} \tag{4}$$

The zeros-poles of the AVR system are given in Table 1. The system has a stable pole, a pair of stable conjugate poles and a pair of unstable conjugate poles, a zero in the left side of the s-plane and a nonminimum phase zero, i.e., in the right side of the s-plane.

Table 1. Poles and zeros of the AVR system without a controller

Poles and Zeros	Values	Stability
$P_1$	-100.04 + 0i	Stable Pole
$P_2$	-16.94 + 4.47i	Stable Pole
$P_3$	-16.94 - 4.47i	Stable Pole
$P_4$	0.21 + 4.23i	Unstable Pole
$P_5$	0.21 - 4.23i	Unstable Pole
$Z_1$	-100+0i	Zero in the left-side of the s-plane
$Z_2$	20+0i	Nonminimum phase zero, i.e., in the right side of the s-plane

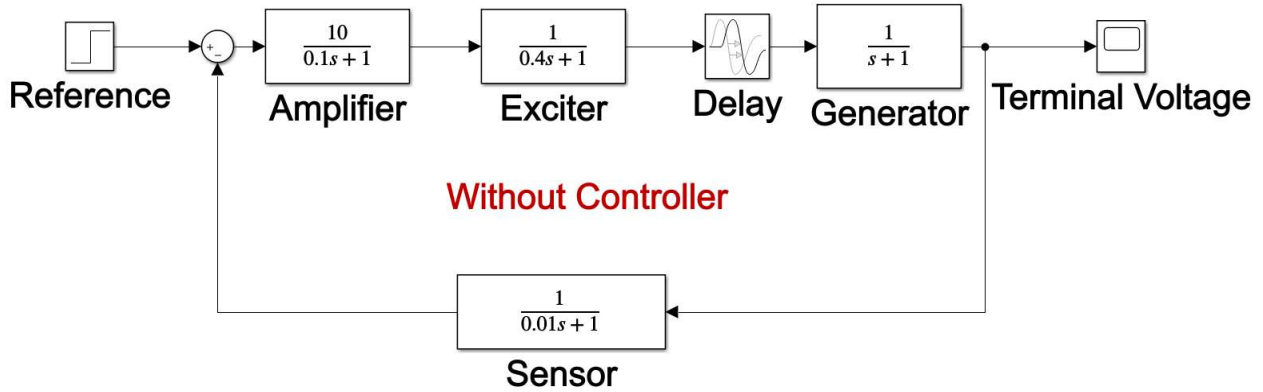

Figure 2. Closed loop AVR model structure with time delay

The dynamic behavior of this system can be observed by a unit step response. For this, a Simulink model is constructed and depicted in Figure 2. We demonstrate a unit step response of the time-delay AVR system without a controller in Figure 3.

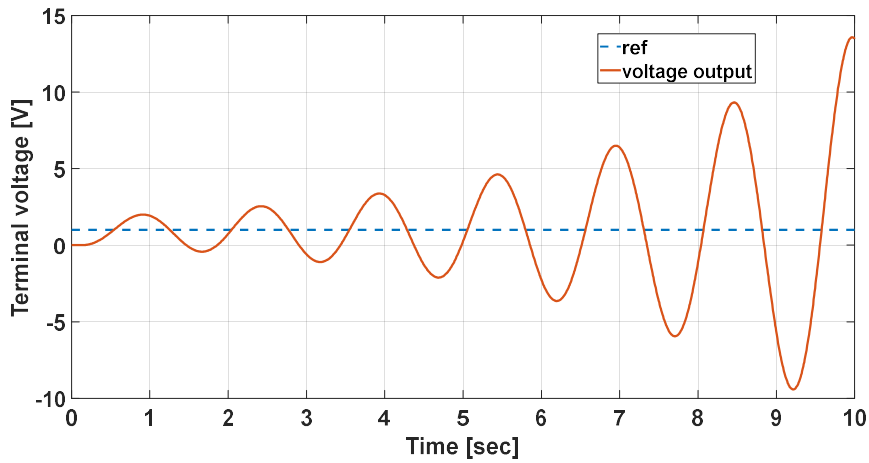

Figure 3. The terminal voltage response of the AVR system without a controller under time delay  $t_s=0.1$  secs

As observed in Figure 3, the output voltage is not tracking the desired reference because the system is unstable. The stability behavior of the system can be better seen by examining the zeros-poles of the AVR system. These unstable poles cause the system to go unstable as seen in Figure 3. It can cause great damage to electricity transmission and distribution systems, protection generators and other generators. They can cause strain on the lines and increase losses. It can also lead to prolonged power outages. We show the open-loop system poles and zeros in the root locus diagram in Figure 4. The main goal in the design is not only to drive the system back to stable form but also to enhance closed-loop system characteristics of the AVR system i.e., maximum overshoot, settling time, rise time and steady-state error with a PID controller. The open-loop root locus plot is given in Figure 4.

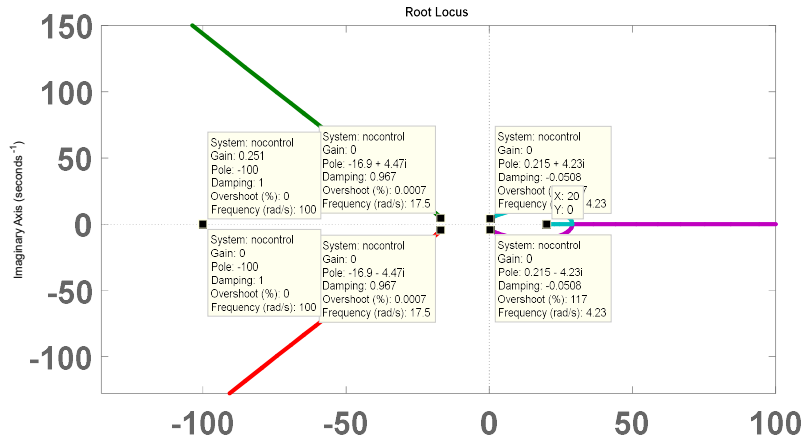

Figure 4. Poles and zeros in open-loop AVR system

The generator output voltage, transient state behaviors should be improved as well as the steady-state error should be reduced to zero in the existence of time-delay and varying load. To achieve these, that is, to bring the system to a point that will show optimal behaviors, a high-performance controller must be added to the system. In this study, a PID controller is chosen for the control of the AVR system. The closed-loop control structure of the AVR system with the PID controller is given in Figure 5.

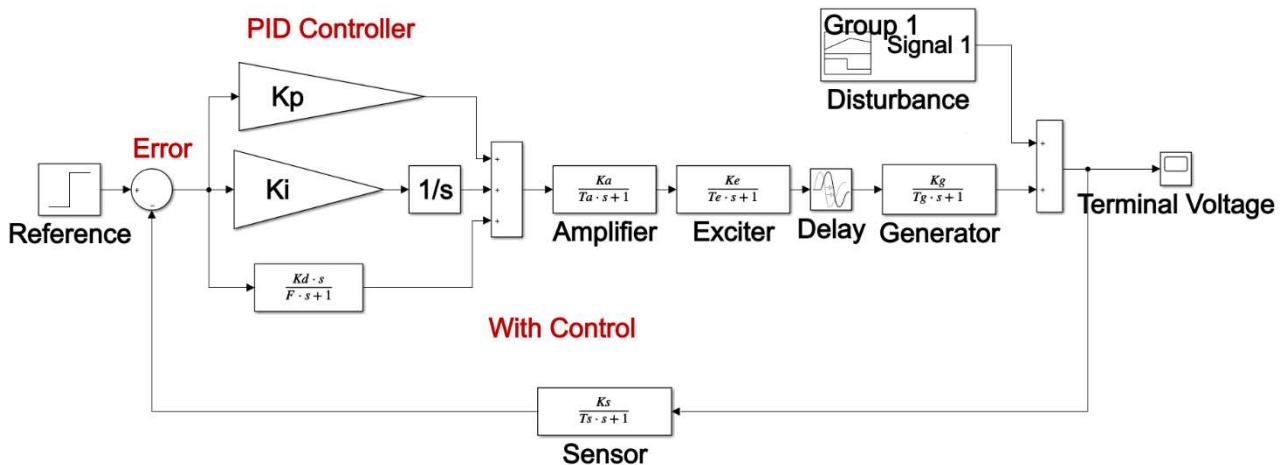

Figure 5. The closed loop-AVR model structure with PID controller and time-delay and disturbance load

The closed-loop transfer function with its  $K_p$  proportional,  $K_i$  integral, and  $K_d$  derivative gains to be determined with the following objective function.

### 2.3 Objective Function

Numerous cost functions have been described in the related studies to determine the PID controller gains to optimally improve the dynamic behavior of the AVR system. Objective functions are including  $M_p$ ,  $t_r$ ,  $t_s$  and  $E_{ss}$  control criteria. It is the performance indicator for the AVR system to have minimum values of these criteria for a unit step response. In this study, we measure the performance using a time-weighted squared error (ITSE) function of the tracking error for a step reference under time-delay and disturbances, combined with a measure of the energy of the incremental control in equation (5).

$$ITSE = \int_0^t t |V_r - V_t|^2 dt = \int_0^t t |e|^2 dt. \tag{5}$$

### 2.4 Proposed PSO Algorithm

The swarms such as insects, herds, birds, and fishes show cooperative behaviors to find food. Each member of these constantly changes the search pattern according to their own and other members' learning experiences. PSO is a meta-heuristic algorithm that makes very few assumptions and can scan very large candidate solution areas. Like other meta-heuristic algorithms, it can guarantee that it finds the most suitable solution.

The PSO algorithm has a population called swarm. It works by having a population of candidate solutions called particles. These particles move in the search area according to a few simple formulas Zhang et al (2015). In PSO, while particles are moving stochastically towards new positions; its speed, its previous best performance, and its neighbors' best previous performance are taken into account Kennedy and Eberhart (2001).

The motions of the particles are guided by their best-known position in the search area as well as the best-known position of the whole herd. Once improved positions are revealed, they will come to guide the herd's movements. The process is repeated and it is hoped that this will result in a satisfactory solution.

The PSO algorithm expresses a part in the swarm in two equations based on its speed and position. These equations (6-7) based on speed and location are given below. PSO evaluates the objective at all particles and records the current position for particle  $p(i)$ , for each  $i$ . In addition, definitions and initial parameters values for the PSO algorithm are given in Table 2. Mühürçü et al. (2017).

Table 2. Parameters and variables for PSO algorithm

Parameter and variables	Defines
$w$	Inertia coefficient
$c_{1,2}$	Acceleration coefficient
$x_i(t)$	$i$ . particle's position
$v_i(t)$	$i$ . particle's velocity
$P_i(t)=pbest$	$i$ . particle's the best position
$g(t)=gbest$	$i$ . particle's global the best position
$T_{sample}$	Sample time
$T_{sim}$	Simulation time
Iteration	Number of iteration for converge
Particals	Number of particles

$$v_i(t + 1) = w * v_i(t) + c_1 * (P_i(t) - X_i(t)) + c_2 * (g_j(t) - X_i(t)), \tag{6}$$

$$x_i(t + 1) = x_i(t) + v_i(t). \tag{7}$$

The update of PSO algorithm is as follows: update the weighted sum of velocity  $v_i(t)$  at time  $t$ , relative difference between the best position  $P_i(t)$  and current position  $X_i(t)$  the particle has seen at time  $t$ , and relative difference between the best position  $g_i(t)$  and the current position  $X_i(t)$  in the global search space at time  $t$  are used to update the velocity at  $t + 1$  in equation (6). Finally, we update the position at  $t + 1$  in equation (7). The standard flow chart for PSO have been shown in Figure 6.

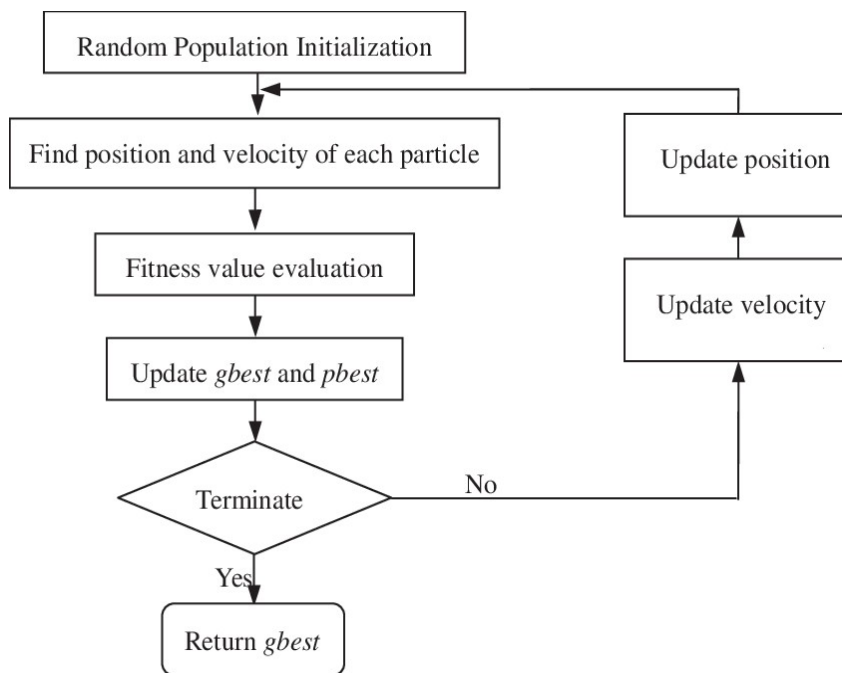

Figure 6. PSO flow cart Wang et al. (2009)

### 3. Simulation Study and Discussion

In this section, we demonstrate the workings of the proposed PID controller for the time-delay AVR system. The optimal gains are computed with PSO optimization using the objective function defined earlier. The proposed PSO-based PID controller with the first-order filter on its derivative structure is implemented in Simulink software, shown in Figure 7. Several techniques including time-domain transient response analysis, frequency-domain analysis, and robustness analysis are carried out with the designed PSO-based PID controller in the sequel.

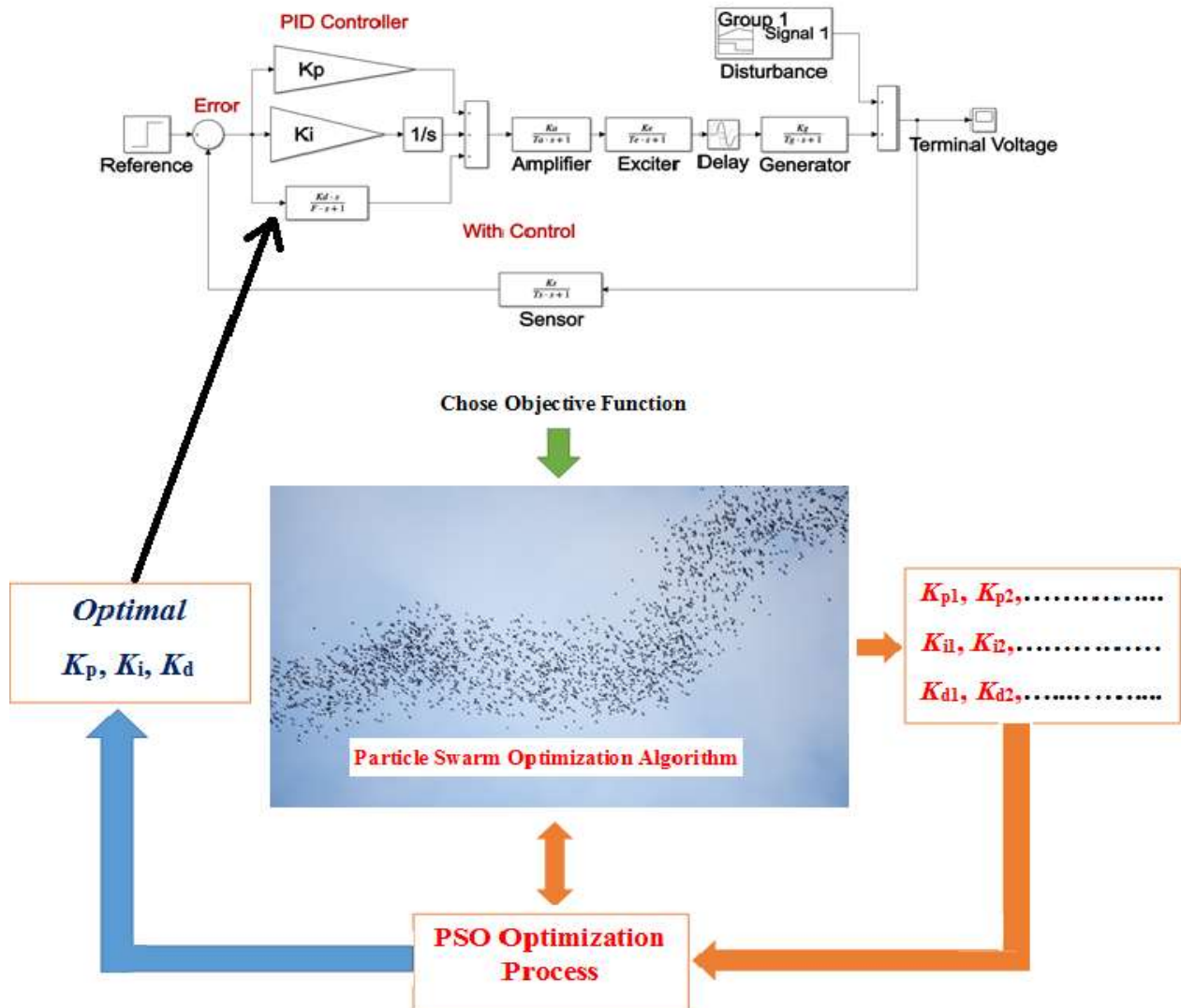

Figure 7. The closed loop-AVR model structure with PSO tuned PID controller and time-delay

As stated, we use ITSE objective in optimization by PID parameters that are calculated with PSO algorithm as shown in Figure 7.  $T_{sample} = 0.001$  secs,  $T_{sim} = 10$  secs, number of iteration is set to 200 and particle size is set to 50. The optimal parameters after several run in MATLAB software are calculated as  $K_p = 0.4275$ ,  $K_i = 0.2640$  and  $K_d = 0.1194$ .

#### 3.1 Root Locus

The Root Locus analysis for the AVR system tuned by the PSO algorithm is demonstrated. the time-delay AVR system presents nonminimum phase behavior, meaning that it has a right half side plane zero that adds negative phase to the system. Thus slow system response and limited bandwidth are imposed. The gains should be carefully determined by the PSO algorithm such that the system remains stable against all perturbations and present a good tracking behavior. The closed-loop transfer function with found PID coefficients is given below:

$$G_{AVR-PID}(s) = \frac{V_t(s)}{V_{ref}(s)} = \frac{-0.0006013s^4 - 0.05024s^3 + 1.03s^2 + 4.175s + 2.64}{4e - 08s^7 + 2.534e - 05s^6 + 0.002816s^5 + 0.07441s^4 + 0.5735s^3 + 2.551s^2 + 5.148s + 2.64}$$

Table 3. Poles and zeros of the AVR system with PID controller

Poles and Zeros	Values	Stability
$P_1$	-500.02+0i	Stable Pole
$P_2$	-99.36+0i	Stable Pole
$P_3$	-25.03+0i	Stable Pole
$P_4$	-2.68 + 4.08i	Stable Pole
$P_5$	-2.68 - 4.08i	Stable Pole
$P_6$	-2.98+0i	Stable Pole
$P_7$	-0.75+0i	Stable Pole
$Z_1$	-100+0i	Zero in the left side of the s-plane
$Z_2$	20+0i	Nonminimum phase zero, i.e., in the right side of the s-plane
$Z_3$	-2.76+0i	Zero in the left-side of the s-plane
$Z_4$	-0.79+0i	Zero in the left-side of the s-plane

We can observe from Table 3, all closed-loop poles are stable with PSO optimized PID controller gains. We have successfully stabilized system, on the other hand, nonminimum phase zero, i.e.,  $Z_2$  still possesses some limitation in terms of achievable time and frequency domain performances.

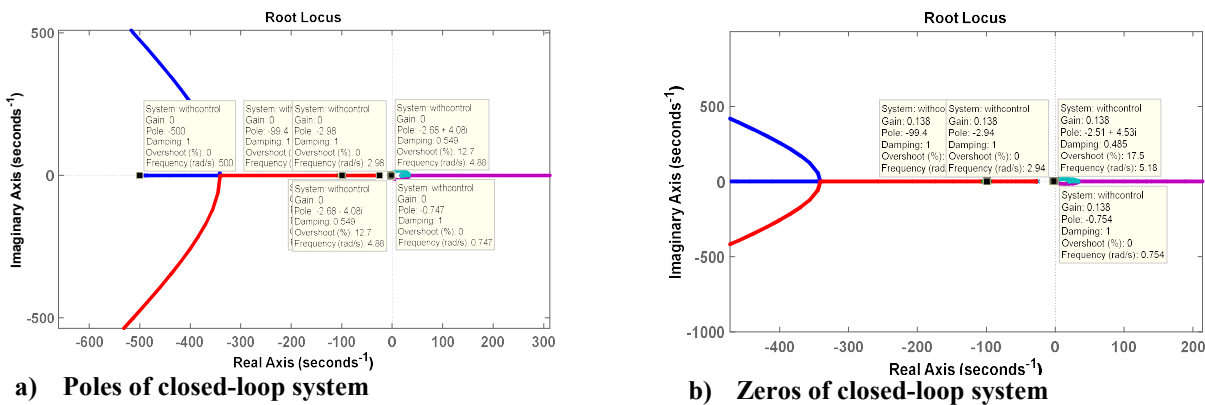

Figure 8. Closed-loop Root locus of AVR system

From Figure 9, we see that all poles of the PID based AVR system lie in the left half side of the s-plane. Therefore, the time-delay AVR system is stable.

### 3.2 Transient Analysis

The transient response to the PID controller optimized by the PSO algorithm for the time-delay AVR system is studied in this section. Performance indices such as peak overshoot, settling time, rise time, and peak time obtained by the proposed PSO algorithm is depicted in Figure 8.

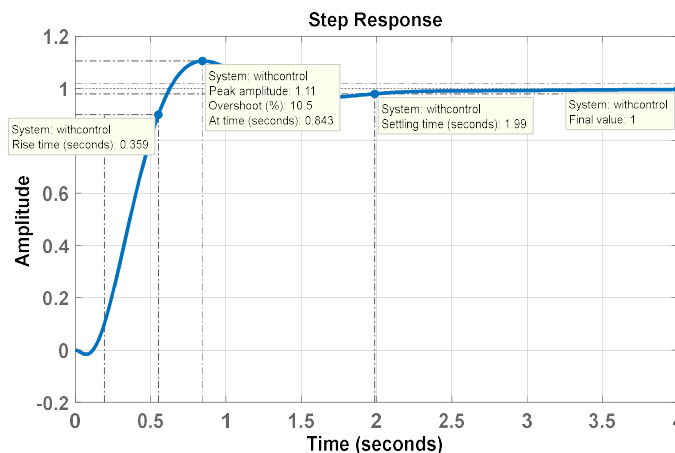

Figure 9. Transient response of AVR system to a unit step input



For system stability maximum overshoot and settling time are essential and desired to maintain at low values. It is noted that maximum overshoot and rise time are conflicted objectives, thus can not be minimized simultaneously. Steady-state behavior of the system is also a dynamic response analysis tool, which is closely related to transient response performance indices.

### 3.3 Bode Analysis

To analyze the frequency domain behavior of the AVR system optimized by the PSO algorithm. magnitude and phase plots are illustrated in Figure 10. For comparison purposes, bode plots of both open-loop and closed-loop (with PID controller) are drawn. The time-delay AVR system with the PSO-based PID controller exhibits a minimum peak gain 0.651 dB at 0.523 Hz, providing maximum phase margin 152. This is realized that the system with time-delay can follow the reference voltage set point with high accuracy.

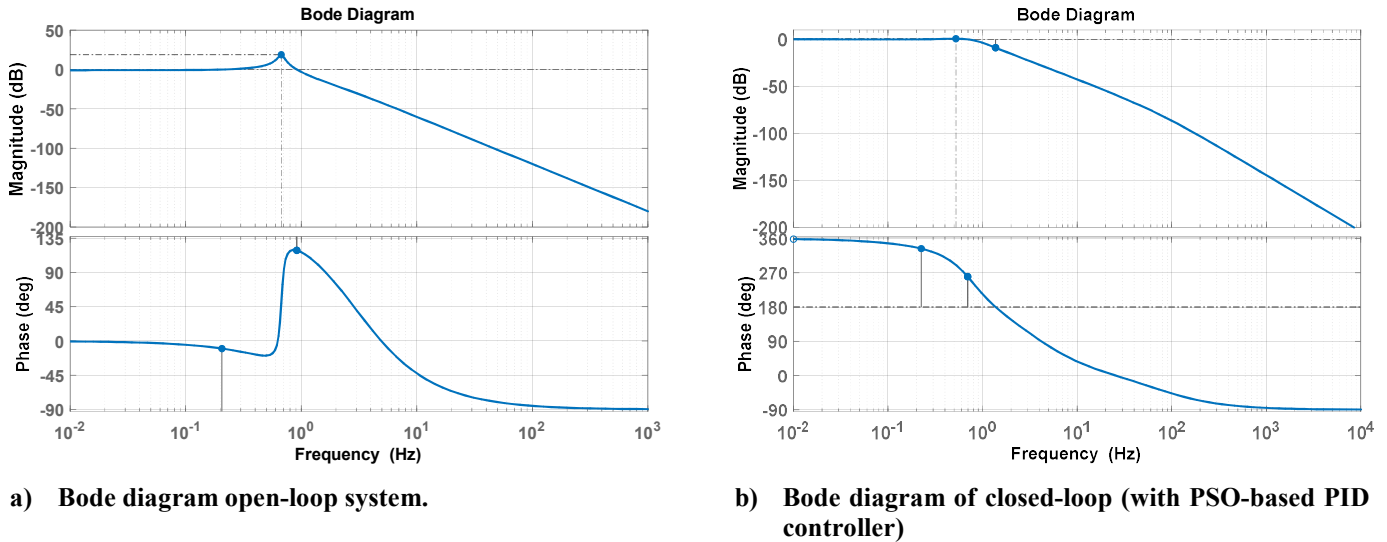
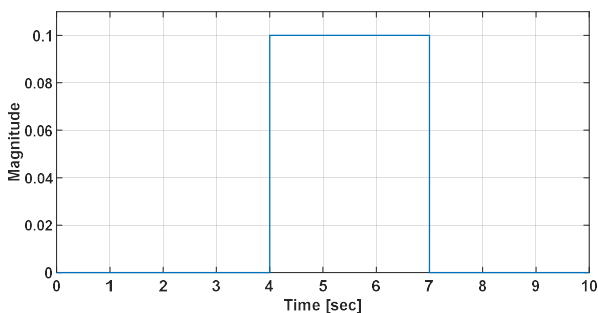

Figure 10. Frequency response of AVR system

### 3.4 Robustness and Disturbance Rejection Analysis

This section is devoted to evaluate the robustness against parametric uncertainties in the system and to represent the disturbance rejection ability of the PSO-based PID controller. First, we analyze, the uncertainties in time constants ( $T_a, T_e, T_g, T_s$ ) are within range  $\pm 50\%$  in steps of  $\pm 25\%$ . We further analyze the robustness against time delay  $t_s$  in the AVR system. Here, the applied disturbance profile, in Figure 11 (a), is also included in the analysis steps. Value of the disturbance signal is  $\pm 10\%$ , applied at  $t=4$  and  $7$  secs. In comparison with nominal values, it is inferred from Figures (b-e), the PID controller optimized with PSO algorithm exhibits satisfactory robustness in spite of large parametric change in time constants of AVR system thus, indicating the PSO-based PID controlled AVR system is robust. As this paper mainly concern to time-delay analysis in control design, we also depict controller performance against uncertainties in time delay. To this end, variation, ranging  $\pm 50\%$  in steps of  $\pm 25\%$  is shown in Figure 11 (f). It is concluded in robustness analysis that the proposed controller tuned by the PSO algorithm derives the system to step reference in presence of parameter uncertainties and unexpected disturbances.



a) Disturbance profile applied to AVR system

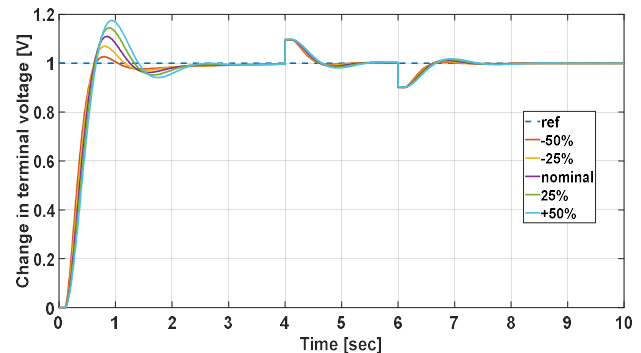

b) Voltage change when  $T_a$  is changing in range of  $\pm 50\%$

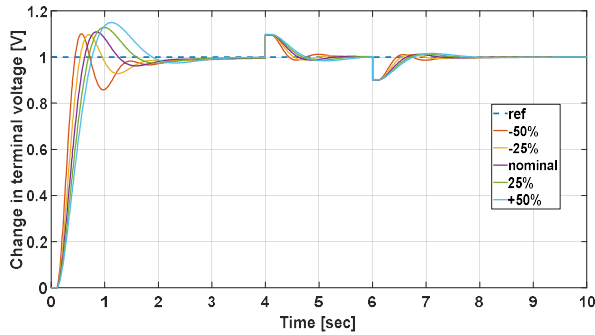

c) Voltage change when  $T_e$  is changing in range of  $\pm 50\%$

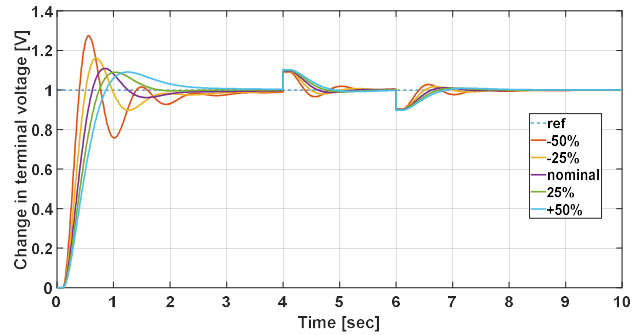

d) Voltage change when  $T_g$  is changing in range of  $\pm 50\%$

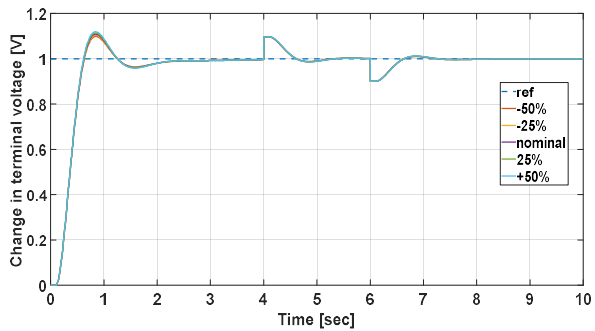

e) Voltage change when  $T_s$  is changing in range of  $\pm 50\%$

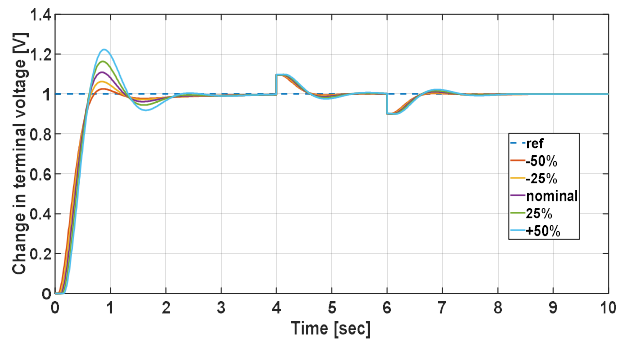

f) Voltage change when  $t_s$  is changing in range of  $\pm 50\%$

Figure 11. Robustness analysis of time-delay AVR system with proposed PSO algorithm.

## 4. Conclusions and Future Works

In this article, the stabilization and tracking problems of the time-delay AVR system based on a PSO optimized PID controller are investigated. We study the performance of the design for the AVR system with ITSE objective function. The proposed cost function is utilized in the PSO algorithm for optimal tuning of the PID controller coefficients. We first analyze the dynamic response quantities including peak overshoot, rise time, settling time, steady-state error. Then, we analyze the Bode plots of the system for the frequency behavior of the AVR system based on the PSO algorithm. Furthermore, the PID controller is tested whether the design is robust under parametric uncertainties and unexpected disturbance loads. The obtained results reveal that the PID controller based on the PSO algorithm is robust against uncertainties in AVR parameters for synchronous generator AVR systems. Future studies will involve analyzing the same system structure with a PID controller based on different heuristic algorithms.

## References

- Bhati, S., & Nitnawwre, D. (2012). Genetic optimization tuning of an automatic voltage regulator system. *International Journal of Scientific Engineering and Technology*, 1(3), 120-124.
- Sahib, M. A. (2015). A novel optimal PID plus second order derivative controller for AVR system. *Engineering Science and Technology, an International Journal*, 18(2), 194-206.
- Gozde, H., & Taplamacioglu, M. C. (2011). Comparative performance analysis of artificial bee colony algorithm for automatic voltage regulator (AVR) system. *Journal of the Franklin Institute*, 348(8), 1927-1946.
- Bingul, Z., & Karahan, O. (2018). A novel performance criterion approach to optimum design of PID controller using cuckoo search algorithm for AVR system. *Journal of the Franklin Institute*, 355(13), 5534-5559.
- Ekinci, S., Hekimoğlu, B., Yurtlu, Ö. F., & Uzer, F. (2018). Whale optimization algorithm for optimal controller design in AVR system. *Proc. IENSC*, 1890-1900.
- Ekinci, S., Hekimoğlu, B., & Eker, E. (2019, October). Optimum Design of PID Controller in AVR System Using Harris Hawks Optimization. In *2019 3rd International Symposium on Multidisciplinary Studies and Innovative Technologies (ISMSIT)* (pp. 1-6). IEEE.
- dos Santos Coelho, L. (2009). Tuning of PID controller for an automatic regulator voltage system using chaotic optimization approach. *Chaos, Solitons & Fractals*, 39(4), 1504-1514.

- Razmjoo, N., Khalilpour, M., & Ramezani, M. (2016). A new meta-heuristic optimization algorithm inspired by FIFA world cup competitions: theory and its application in PID designing for AVR system. *Journal of Control, Automation and Electrical Systems*, 27(4), 419-440.
- Ekinci, S., & Hekimoğlu, B. (2019). Improved kidney-inspired algorithm approach for tuning of PID controller in AVR system. *IEEE Access*, 7, 39935-39947.
- Ribeiro, R. L. A., Neto, C. M. S., Costa, F. B., Rocha, T. O. A., & Barreto, R. L. (2015). A sliding-mode voltage regulator for salient pole synchronous generator. *Electric Power Systems Research*, 129, 178-184.
- Elsisi, M. (2019). Design of neural network predictive controller based on imperialist competitive algorithm for automatic voltage regulator. *Neural Computing and Applications*, 31(9), 5017-5027.
- Abegaz, B., & Kueber, J. (2019). Smart Control of Automatic Voltage Regulators using K-means Clustering. *IEEE 14th Annual Conference System of Systems Engineering (SoSE)*, Anchorage, AK, USA, 2019.
- Bhutto, A. A., Chachar, F. A., Hussain, M., Bhutto, D. K., & Bakhsh, S. E. (2019, January). Implementation of Probabilistic Neural Network (PNN) Based Automatic Voltage Regulator (AVR) for Excitation Control System in MATLAB. In *2019 2nd International Conference on Computing, Mathematics and Engineering Technologies (iCoMET)* (pp. 1-5). IEEE.
- Ortiz-Quisbert, M. E., Duarte-Mermoud, M. A., Milla, F., Castro-Linares, R., & Lefranc, G. (2018). Optimal fractional order adaptive controllers for AVR applications. *Electrical Engineering*, 100(1), 267-283.
- J. Kennedy and R. C. Eberhart, "Particle swarm optimization," in *Proc. IEEE Int. Conf. Neural Networks (ICNN'95)*, Perth, Australia, 1995, vol. IV, pp. 1942-1948.
- Doctor, S., Venayagamoorthy, G. K., & Gudise, V. G. (2004, June). Optimal PSO for collective robotic search applications. In *Proceedings of the 2004 Congress on Evolutionary Computation (IEEE Cat. No. 04TH8753)* (Vol. 2, pp. 1390-1395). IEEE.
- Jeong, Y. W., Park, J. B., Jang, S. H., & Lee, K. Y. (2010). A new quantum-inspired binary PSO: application to unit commitment problems for power systems. *IEEE Transactions on Power Systems*, 25(3), 1486-1495.
- Zhou, C., Yin, K., Cao, Y., & Ahmed, B. (2016). Application of time series analysis and PSO-SVM model in predicting the Bazimen landslide in the Three Gorges Reservoir, China. *Engineering geology*, 204, 108-120.
- Godio, A., & Santilano, A. (2018). On the optimization of electromagnetic geophysical data: Application of the PSO algorithm. *Journal of Applied Geophysics*, 148, 163-174.
- Madoliat, R., Khanmirza, E., & Pourfard, A. (2017). Application of PSO and cultural algorithms for transient analysis of natural gas pipeline. *Journal of Petroleum Science and Engineering*, 149, 504-514.
- Malmir, P., Suleymani, M., & Bemani, A. (2018). Application of ANFIS-PSO as a novel method to estimate effect of inhibitors on Asphaltene precipitation. *Petroleum Science and Technology*, 36(8), 597-603.
- Birs, I., Muresan, C., Nascu, I., Folea, S., & Ionescu, C. (2018, November). Experimental results of fractional order PI controller designed for second order plus dead time (SOPDT) processes. In *2018 15th International Conference on Control, Automation, Robotics and Vision (ICARCV)* (pp. 1143-1147). IEEE.
- Narang, A., Shah, S. L., & Chen, T. (2010, June). Tuning of fractional PI controllers for fractional order system models with and without time delays. In *Proceedings of the 2010 American Control Conference* (pp. 6674-6679). IEEE.
- Zhang, Y., Wang, S., & Ji, G. (2015). A comprehensive survey on particle swarm optimization algorithm and its applications. *Mathematical Problems in Engineering*, 2015
- J. Kennedy and R. C. Eberhart, *Swarm Intelligence*. San Francisco, CA: Morgan Kaufmann, 2001.
- Mühürçü, G., Kose, E., Muhurcu, A., & Kuyumcu, A. (2017, September). Parameter optimization of PI controller by PSO for optimal controlling of a buck converter's output. In *2017 International Artificial Intelligence and Data Processing Symposium (IDAP)* (pp. 1-6). IEEE.
- Wang, B., Wu, Z. S., Zhao, Z., & Wang, H. G. (2009). Retrieving evaporation duct heights from radar sea clutter using particle swarm optimization (PSO) algorithm. *Progress In Electromagnetics Research*, 9, 79-91.