

A CFD Assisted Study: Investigation of the Transformation of A Recuperative Furnace to Regenerative Furnace For Industrial Aluminium Melting

Ömür Bozkurt¹, Mehmet Fatih Kaya^{*2}

ABSTRACT

In industrial applications, pre-heating and re-heating of the exhaust air have very big savings of fuel costs and emissions. Especially, recuperative, and regenerative furnaces are an efficient method to obtain more heat sources. Regenerative furnace systems provide superior cost and fuel savings in industrial applications when they are adapted with suitable processes. In this study, recuperative aluminum melting furnaces are transformed with regenerative furnaces to obtain high performance aluminum melting in the manufacturing system. Several calculations and evaluations are conducted to observe the difference in the melting furnace systems by the help of mathematical modelling and CFD analysis. According to CFD results, as a design criterion, 1654 J/kg enthalpy change is calculated to improve the system performance for regenerated recuperative systems. Fuel consumption of the system is decreased around 30% and payback time is calculated as 1.43 year according to December 2018 values.

Keywords: Regenerative burners, burners, energy efficiency, industrial energy efficiency.

CFD Destekli Bir Çalışma: Endüstriyel Uygulamalarda Kullanılan Reküperatif Alüminyum Ergitme Fırınlarının Rejeneratif Sisteme Dönüştürülmesinin İncelenmesi

ÖZ

Endüstriyel uygulamalarda yakma havasının ön ısıtması ve yeniden kullanılması yakıt giderlerinde ve emisyon oluşumunda büyük tasarruflar sağlamaktadır. Özellikle reküperatif ve rejeneratif yakma sistemlerine sahip fırınlar yakıtın ısısından daha fazla yararlanabilmeleri sebebiyle oldukça verimli sistemlerdir. Rejeneratif fırın sistemleri uygun sistemlere adapte edildiklerinde büyük oranda yakıt tasarrufu sağlayarak ekonomik bir yakma prosesi gerçekleşmesini sağlamaktadırlar. Bu çalışmada, bir işletmede kullanılan reküperatif yakma sisteminin rejeneratif yakma sistemi ile değiştirilerek alüminyum ergitme işleminde daha yüksek performanslı bir proses oluşturulması sağlanmıştır. Bu ergitme sistemlerinin karşılaştırmalarının yapılması için matematiksel modeller ve CFD analizler yapılarak bazı hesaplamalar ve değerlendirmeler yapılmıştır. CFD analizlerine göre 1654 J/kg değerinde bir entalpi kazanımı sağlanarak reküperatif fırın sisteminin performansının artırılacağı sonucuna varılmış olup bu değerler tasarım kriteri olarak kullanılmıştır. Ayrıca, reküperatif sistemin rejeneratif sisteme dönüştürülmesi ile sistemin yakıt tüketiminde %30'luk bir düşüş gözlenmiş olup, fırın veriminde iki katlık bir artış elde edilmiştir.

Anahtar Kelimeler: Rejeneratif yakma sistemleri, yakıcılar, enerji verimliliği, endüstriyel enerji verimliliği.

* İletişim Yazarı

Geliş/Received : 22.12.2020

Kabul/Accepted : 13.01.2021

¹ Haşcelik Kablo Co. Research and Development Center, Organize San. Bol. 18. Cad. No:20, 38070 Melikgazi/Kayseri, OBozkurt@hascelik.com.tr, ORCID: 0000-0003-1360-1086

² Erciyes University, Department of Energy Systems Engineering, Heat Engineering Division, 38039, Kayseri kayamehmetfatih@erciyes.edu.tr, ORCID: 0000-0002-2444-0583

EXTENDED ABSTRACT

Introduction/Background

Due to the high demand in energy in the world, efficient energy conversion systems are highly desired. Especially, in industrial applications, most of the energy consumption in melting systems are caused by furnaces or boilers. Thus, high performance combustion is very important for economical metal production. Moreover, these systems are well-known as non-preheated, recuperative, and regenerative combustion systems. However, design criteria calculations and net enthalpy gain is not well-known due to its complexity. In the literature, most of the studies are focused on the combustion performance of these systems. On the other hand, different approach for the transformation of the furnace is important to make simpler calculations for these systems.

Objectives/Research Purpose

In this study, a CFD assisted study is conducted for transformation of a recuperative furnace to regenerative system. Thanks to measured and calculated data, design criteria of regenerative furnace is specified. This study shows that CFD tools can help to obtain approximate velocity and enthalpy value of engineering systems without expensive measurement equipment or complex calculations. In additions, this study shows the difference of recuperative and regenerative furnaces for different conditions. Payback time of investment is calculated to help designers or investors for their regenerative furnace transformation process as techno economical approach.

Methods/Methodology

In this study, firstly measurements in recuperative furnace's surface and flue temperatures are conducted using thermal camera images. Then, recuperative furnace is modelled in 1:1 in Solid Works design program to use it in Comsol Multiphysics CFD analysis. In CFD analysis, velocity, temperature, and enthalpy values of recuperative furnace is calculated. Thanks to calculated and measured data in industrial recuperative furnace, design criteria of regenerative system is specified, and available net heat gain is determined. Then, systems are compared with thermal camera images and monthly fuel consumption values.

Results/Findings

According to results, 1654 J/kg enthalpy change is calculated to improve the system performance. Despite 91.8 m³ fuel is consumed in burner for recuperative burner in regenerative furnace, to produce one-ton product, only 66.6 m³ of fuel is consumed. This the meaning of regenerative transformation of furnaces may decrease the fuel consumption up to 43%.

Discussion and Conclusions

This study demonstrated the benefit of recuperative furnace transformations in industrial applications. In regenerative furnace, 23.4% lower temperature is obtained in the flue region. Fuel consumption is decreased to 43% in regenerative furnace compared to non-preheated furnace. In regenerative furnace, 27.45% lower energy consumption is obtained compared to recuperative furnace. Payback time of the transformation process is calculated as 1.43 year, which is a good time value for a big industrial company who wish to plan change their recuperative or non-preheated furnaces with regenerative furnace technology.



1. INTRODUCTION

The energy demand in the world increases remarkably due to the higher population rate and industrialization. Especially hydrocarbon-based fuels have very big importance in the manufacturing industry as a source of heat. Thus, using these fuels efficiently is very crucial to provide sustainable manufacturing and environmental technologies. Energy need in the industry increased due to the high economic activities. The energy demand in this sector depends on countries, regions, their technological development level, economic situation and production rates [1]. Industrial boilers and furnaces have very big importance for melting, sintering, cooking, drying, etc. processes [2, 3]. Most of these furnaces are designed for the special processes and alongside of raw materials, required energy for these systems must be supplied. Besides the quality of the product the energy consumption of the furnaces to produce per ton of product is another problem to solve for the energy efficiency studies [4, 5]. Almost 35% of world's total energy is used in industry [6]. Steel and Iron production industries are one of the most energy consumed industry by 24 EJ (24x10¹⁸ J) per year and this value is 5% energy consumption value of the world [7, 8]. This energy consumption value has the biggest part of the cost of a product. Thus, it must have priority to decrease product cost for the sustainability of manufacturing processes [9]. Energy efficiency is one of the most important part of the lower costs in industrial application. Thus, investigation studies for the energy losses and fixing them with efficient solutions are very important. Many researchers are studied in energy industry to lowering these losses [10-13]. Conversion of industrial furnaces from non-preheating to recuperator, or recuperative furnaces to regenerative furnace improves the energy efficiency of the system between 50-60%. Recuperator and regenerative furnaces are mostly using in the industry rather than the non-preheated furnaces. Recuperator furnaces are using to recover waste heat of gas flow in the furnace and boilers. In the metallic walls of recuperator, heat of flue gases and air is exchanged by conduction. In these systems channels are used to preheat and move air before combustion process [2]. On the other hand, regenerative furnaces are used in bigger capacity processes in metal and glass melting industry. These systems firstly established by Robert Stirling with the name of economizer or regenerators. However, industrial applications were firstly announced by Friedrich Siemens. He has a patent for regenerative furnace using as boiler or melting processes. This system was commonly used in Zn, iron and steel reheating or melting in the metal industry [14]. In 1980s, recuperative furnaces become widespread in industry. Then, highly efficient, small-middle capacity direct burning technologies adapted to industry with regenerative furnaces [15]. The most important parameters in regenerative furnaces are the reversal time of the heat, insulation thickness, heat conductivity factor, heat storage properties and the regenerator size. Especially, during the furnace operating

process, heat losses from the surface of the furnace and air leakages decrease the performance of the system.

In this study, recuperative and regenerative furnaces are compared and a transform application from recuperative melting furnace to regenerative melting furnace for Al melting is performed for Hasçelik Kablo Co. facility. A CFD model is used to investigate the velocity value of the flue gas and available enthalpy gain for regeneration process. Comsol Multiphysics software is used to investigate heat transfer around the inner and outer surface of the recuperative surface. Recuperative and regenerative furnaces are studied by fuel consumption and efficiency value to explain benefit of conversion the energy efficient method in the industrial applications.

2. MATERIALS AND METHOD

2.1 Waste Heat Recovery

In industrial furnaces, hot gases are using to conduct heat from one substance to another. Only limited heat can be used for heating the product of the process. The most important part of the heat cannot be used in the system due to heat losses from furnace wall or surface, open surface and flue . Thus, efficiency is very important to investigate these losses to compare working parameters of furnaces. Thermodynamically efficiency is the ratio of obtained energy and fuel energy supplied to furnace.

The useful heat output is the heat that conduct by heat for the melting process. The efficiency of this system can be shown by following equation:

$$\eta(\%) = \frac{(Q_{Useful})}{Q_{Total}} \times 100 \quad (1)$$

Another efficiency term is the combustion efficiency. This efficiency can be shown as Eq.2 as below:

$$\eta_{combustion} (\%) = \frac{(Q_{Total} - Q_{FlueLoss})}{Q_{Total}} \times 100 \quad (2)$$

In industrial furnaces, re-heating of inlet air will improve the system combustion efficiency, thus it will decrease the fuel consumption. Another important factor in the industrial furnaces is the humidity losses. Because of the water vapor in the system, humidity can store useful heat of the system through the flue region. Therefore, it causes lower efficiency of the system. The furnace heat can be shown using Eq.3 as below:



$$Q_{furnace} = [Q_{Total} - (Q_{Humidity} + Q_{Flue})] \quad (3)$$

In flue gas, CO₂ and N₂ conduct heat through the out of the furnace system. Moreover, redundant amount of O₂ also conduct useful heat from inside the furnace. Thus, heat losses should be controlled by optimization of air and flue gas temperature [16]. Regenerative burners can recover 90% of heat from flue exhaust to heat inlet air of the system. Thanks to counter flow of regenerated heat and inlet air flow, inlet temperature of combustion mixture may reach up to flue temperature. It means a big advantage during combustion to improve melting efficiency of furnaces [17].

In the industrial applications, there are two type of industrial regenerative burners. First one is single box and the second one is the double box regenerative burners [15]. Single box regenerative burners consist of at least two regenerators and the combustion is continuous. Moreover, it is possible to connect these systems three or more regenerators. During the combustion process, when one of the regenerator burner under combustion, other burners are in the regeneration process in return [17].

In double combustion type regenerative burners, there are burner couples in the system. In addition, every burner has regenerator box or heat exchangers. When a burner under combustion process, other burner recovers the heat for energy regeneration for the system. In regenerative burners, there are two important components. One of them is the air burner which works as exhaust port, other one is the heat storage balls or honeycomb heat exchangers. These storage balls have very big advantages like high temperature resistant (2000°C melting point), high purity, high thermal stability, high thermal and mechanical strength. They usually produce from Al₂O₃ materials. These balls also effect the combustion time which is usually between 5-60 second. Storage balls have better efficiency than honeycomb heat exchangers. As can be seen in all information related regenerative burners, they have excellent benefits in the industrial boilers or burners for the energy efficiency studies. Thus, it is important to transform an industrial process with regenerative furnaces.

In recuperated burners, air inlet is heated with a heat exchanger positioned from flue region. In Haşçelik Kablo Co. a recuperated burner is transformed to regenerative burner. In a recuperative burner, it is possible to heat combustion chamber's air up to 800°C. They are suitable for efficient burning and low emission applications comparing to non-preheated applications. Firstly, thermal camera images are analyzed to obtain heat losses on the outer surfaces of the furnace. Then, transformation process is conducted using mathematical modelling and numerical calculations.

2.2 Thermal Camera Measurements for Surface Temperature Analysis on Recuperative Burner

In Figure 1, schematic view of recuperative burner and its industrial application in

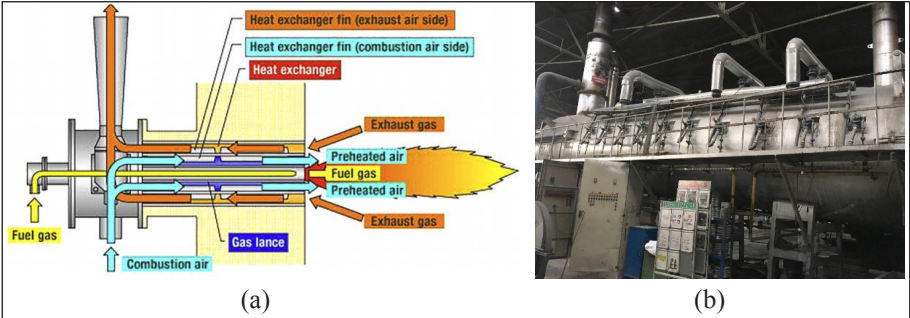

Figure 2. a) Schematic View of the Recuperative Burner [18], b) Recuperative Burner in Hasçelik Kablo Co. Al Melting Process

Hasçelik Kablo Co. can be seen.

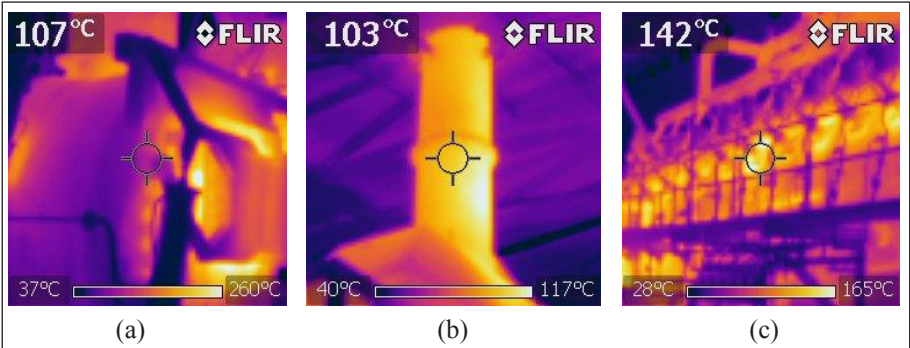

Figure 2. Recuperative Burner Thermal Camera Images, a) Furnace Flap, b) Flue, c) Wall Surface Before Transformation to Regenerative Burner

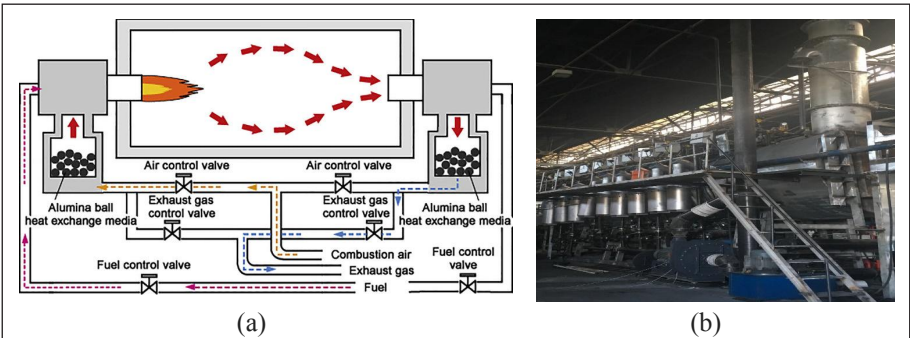

Figure 3. a) Schematic View of the Regenerative Burner Process [18], b) Regenerative Burner in an Industrial Al Melting at Hasçelik Kablo Co.



In Figure 2, obtained thermal camera view can be seen in different surfaces of the recuperative burner of Al melting furnace.

As can be seen in Figure 2, furnace flap temperature is measured as 107 °C and flue temperature is measured as 103 °C, respectively. On the other hand, wall surfaces of the furnace is measured between 142-150 °C. Here it is clear that the biggest part of the heat is losing from the surfaces of the furnace due to low efficiency of bricks, combustion, and reheating process. In Figure 3, regenerative burner details can be seen in an Al melting furnace.

In a regenerative burner, exhausted flue gas supply through the air inlet region by the help of a heat exchanger in counter flow conditions. In Figure 3.b, transformed Al melting furnace can be seen in Hasçelik Kablo Co. facility. Fuel consumption is measured using methane gas flow meter and it is recorded for all type of burners, respectively. Temperatures are measured by thermal camera images and digital heat controllers. Velocity and the temperature of the flue is measured for different burner types, respectively.

2.3 Mathematical Modelling

In aluminum melting furnaces, there are two open sections which are entrance and the outlet regions. The flue gas outlet temperature and the heat losses through the furnace walls have very big heat losses. Thus, thermodynamic investigation and mathematical models are important tools to simulate these losses. In Figure 4, different sections of a recuperative furnace can be seen.

Firstly, an energy analysis equation is presented to observe the system energy equilibrium. For a closed thermodynamic system energy equilibrium can be seen in Figure 5. According to the first law of thermodynamics, a closed system may exchange energy but cannot exchange any matter through its boundaries. The first law of thermodyna-

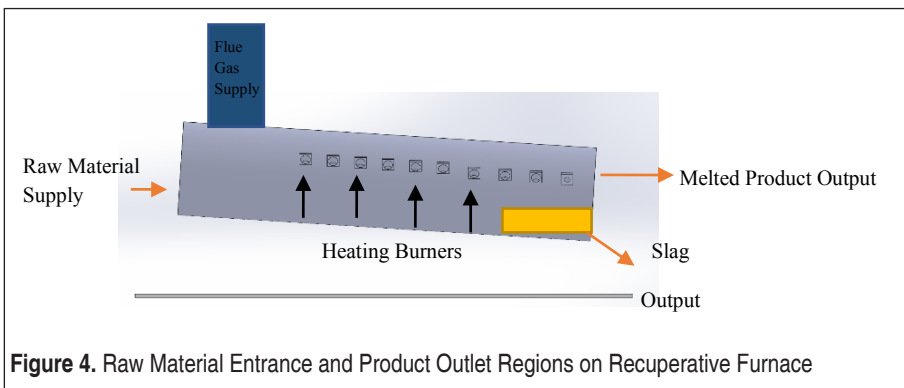

Figure 4. Raw Material Entrance and Product Outlet Regions on Recuperative Furnace

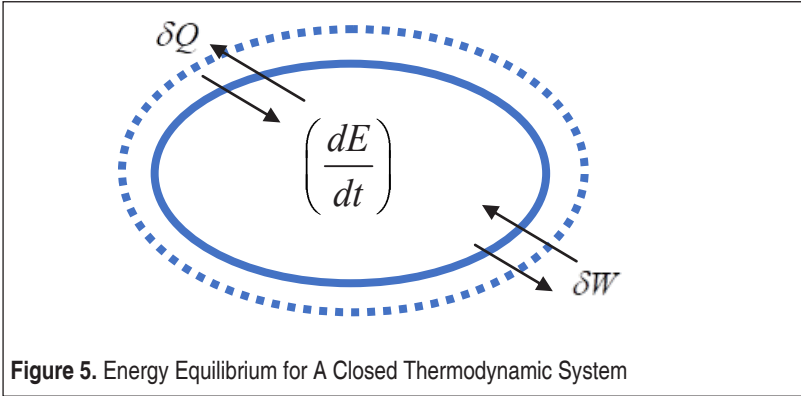

Figure 5. Energy Equilibrium for A Closed Thermodynamic System

First law of thermodynamics states that the change in internal energy of a system equals the net heat transfer into the system minus the net work done by the system.

Internal energy change may be given as Eq.4:

$$\delta Q - \delta W = \frac{dE}{dt} \quad (4)$$

Here, Q is the net heat transfer, W is the net-work and $\frac{dE}{dt}$ is the internal energy change of the system. In a melting furnace, matter exchange occurs from raw material input to the product outlet process. Thus, the energy balance can be given as an open system.

In Figure 6, an open system can be seen with heat losses and matter exchange, schematically. As can be seen in Figure 6, during the entrance of raw material Q_{loss1} , on

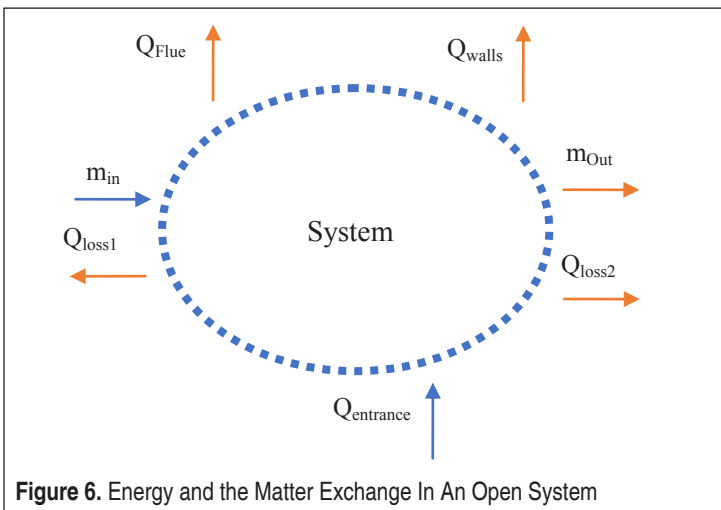

Figure 6. Energy and the Matter Exchange In An Open System



the furnace walls Q_{walls} , in flue Q_{Flue} , through the runner Q_{loss2} can be observed. Moreover, during the raw material entrance min, from the burners $Q_{entrance}$ and during the melted metal transfer to the recreation furnace Q_{loss1} occur.

For an open system, due to the matter exchange, energy balance can be shown as Eq.5.

$$\left(\frac{dE}{dt}\right)_{sistem} = \sum_{i=1}^n \dot{m}_i \left(h + \frac{V^2}{2} + gZ \right)_i - \sum_{j=1}^p \dot{m}_j \left(h + \frac{V^2}{2} + gZ \right)_j + \sum \dot{Q} + \sum \dot{W} \quad (5)$$

In a regenerative system these energy calculations may be shown as Figure 7.

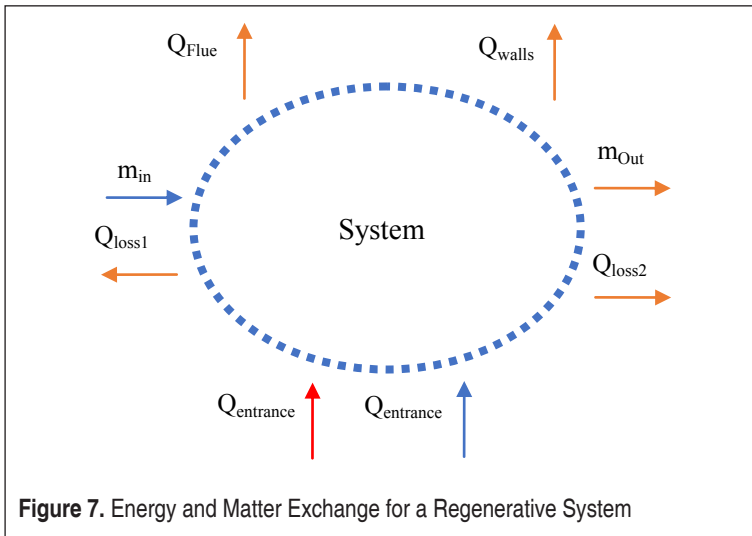

Figure 7. Energy and Matter Exchange for a Regenerative System

As can be seen in Figure 7. in a regenerative furnace Q_{total} entrance will be the sum of the $Q_{entrance}$ and $Q_{regenerative}$. Thus, it will improve the efficiency of the system. For a regenerative system energy balance can be given as Eq.6 as below:

$$\sum_{i=1}^n \dot{m}_{in} \left(h + \frac{V^2}{2} + gZ \right)_i - \sum_{j=1}^p \dot{m}_{out} \left(h + \frac{V^2}{2} + gZ \right)_j + (Q_{Re\ generative} + Q_{Entrance}) - (Q_{Flue} + Q_{Walls} + Q_{Losses}) = \left(\frac{dE}{dt}\right)_{sistem} \quad (6)$$

By the help of CFD software COMSOL Multiphysics, these heat losses region will be investigated and regenerative heat gain “ $Q_{regenerative}$ ” is calculated, theoretically.

In CFD modelling, to provide conservation of momentum, velocity can be calculated

by Eq.7. and Eq.8 for fluid flow regions.

$$\nabla(\rho u) = 0 \quad (7)$$

$$\rho(u \cdot \nabla)u = \nabla \left[-pcl + \mu(\nabla u)^T - \frac{2}{3} \mu(\nabla u)l \right] + F \quad (8)$$

Energy equation is used to investigate heat exchange between solid, liquid and gas phases. The energy equation can be shown as Eq.9.

$$\rho C_p u \cdot \nabla T = \nabla(k \nabla T) + Q \quad (9)$$

2.4 Numerical Solutions

Recuperative furnace is modeled in 3D modelling software Solid Works and converted to COMSOL Multiphysics interface. In Figure 8, grid view of the aluminum melting furnace can be seen.

All solutions are made in COMSOL Multiphysics module with 108630 boundary elements and 1466081 elements with mesh independency. Walls of the furnace are isolated, and furnace raw material supply doors estimated as closed. Materials and their

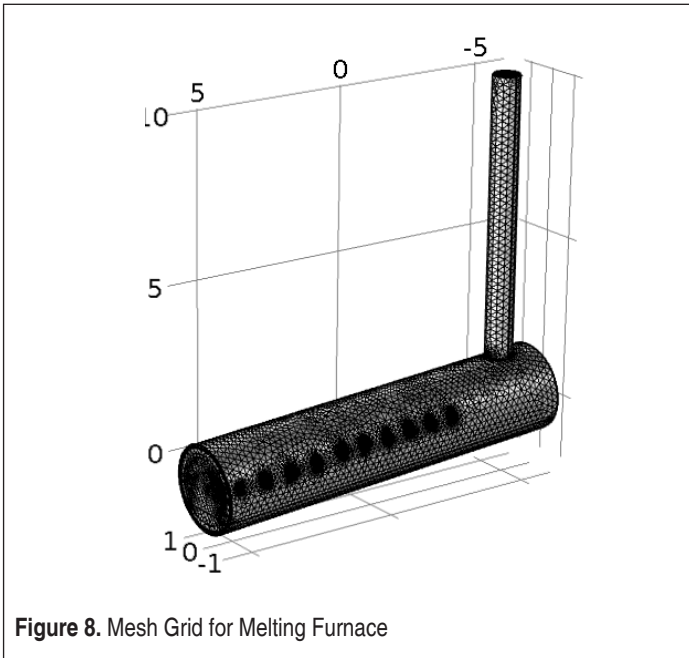



Table 1. Materials for Furnace Design

Component	Material	Cp [J/(kg.K)]	K [W/(m.K)]
Furnace Outer Wall	Structural Steel	475	24.5
Insulation 1	A360	0.84	0.221
	Al-30 Vol SiC		
Insulation 2	Aluminosilicate fire clay brick	0.8	0.1

properties in the melting furnace can be seen in Table 1.

3. RESULTS AND DISCUSSIONS

3.1 Flue Exhaust Gas Velocity

Firstly velocity analysis are conducted. Because, the velocity of the flue gas is very important before the transformation of recuperative furnaces to the regenerative furnace. Moreover, it is possible to any additional fan usage power can be calculated by this velocity value. In Figure 9, the velocity change of the recuperative melting furnace can be seen.

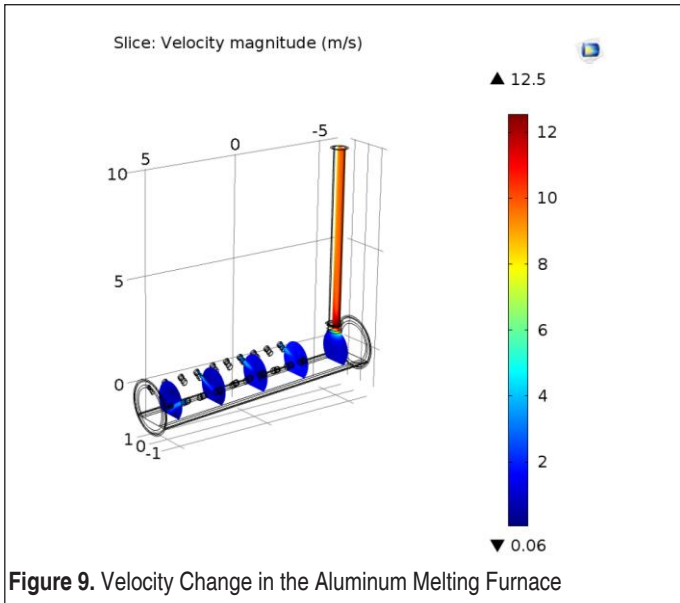

As can be seen from Figure 9, the velocity value is maximum by 12.5 m/sn on the flue gas region. On the other hand, inside the furnace, velocity is changed between 2-4 m/sn. Wide section of the furnace geometry provided lower velocity due to the higher pressure values. In the narrow section of the flue, fluid flow is accelerated to transfer matter and heat from the furnace.

3.2 Temperature Change in the Furnace

Temperature distribution inside the furnace can be seen in Figure 10. As can be seen in Figure 10, furnace walls are around 150 °C and the inside of the furnace is around 700-750 °C. These values are almost the same as thermal camera and the temperature measurement data inside the furnace.

As can be shown in Figure 2, the thermal camera shows the surface of the flue is around 100-110 °C and the wall surface of the furnace is around 140-150 °C. These values fit the calculated values from the CFD simulations. Thus, it is possible to calculate approximate heat loss from the flue of the furnace.

According to the simulation data 1654 J/kg enthalpy change can be regenerated to improve the efficiency of the system. These CFD values are used as the design parameter of the regenerative furnace.

3.3. Thermal Camera Measurements for Surface Temperature Analysis on Regenerative Burner After Transformation

After changing recuperative burner with regenerative burner thermal camera images,

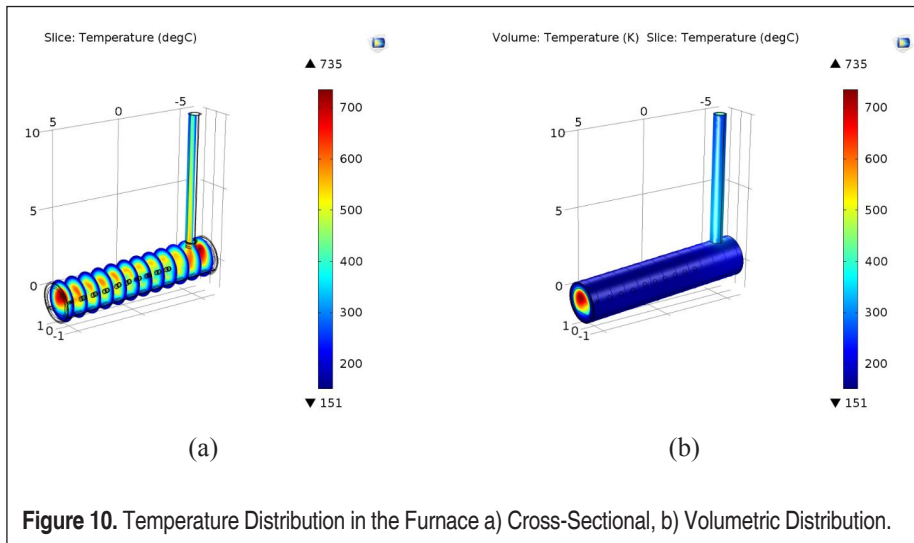

Figure 10. Temperature Distribution in the Furnace a) Cross-Sectional, b) Volumetric Distribution.

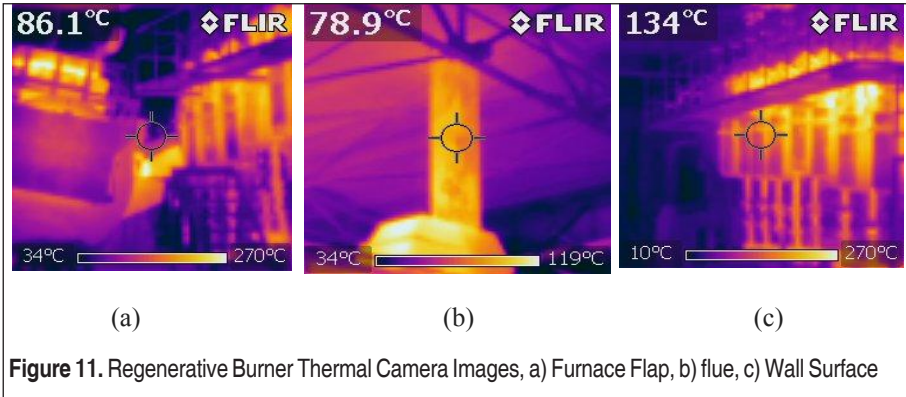

Figure 11. Regenerative Burner Thermal Camera Images, a) Furnace Flap, b) flue, c) Wall Surface

furnace flap heat losses, fuel consumption and efficiency values are compared. In Figure 11, thermal camera images of transformed furnace can be seen in the same region.

As can be seen in Figure 11, furnace flap surface temperature is decreased from 107 °C to 86.1 °C, flue temperature is decreased from 103 °C to 78.9 °C and wall surface temperature of the furnace is decreased from 142 °C to 134 °C, respectively. Transformation of recuperator furnace to regenerative furnace decreased the all-surface heat loss from the furnace.

In addition, in melting furnaces loading furnace flaps affects the flue exhaust gas temperature due to the rapid cooling during raw Al supply. Thus, it is important to inves-

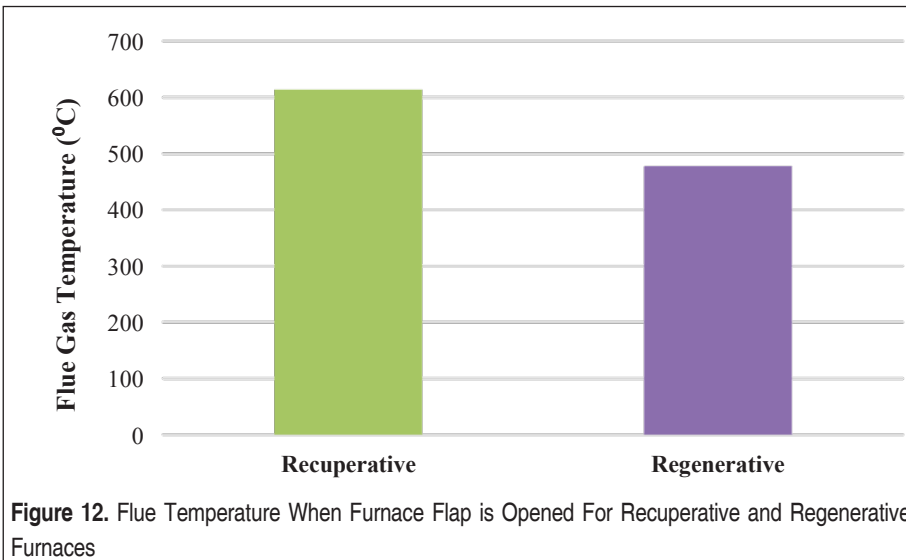

Figure 12. Flue Temperature When Furnace Flap is Opened For Recuperative and Regenerative Furnaces

tigation the open and close loading condition after transformation of the recuperative furnace. In Figure 12, the flue temperature can be seen when furnace flap is opened for raw material loading.

It can be seen in Figure 12, there is 22% lower heat loss in the regenerative furnace in temperature measurements due to its brick improvement and heat capacity inside the furnace. In Figure 13, closed flap condition flue gas temperature comparison can be seen.

It can be seen clearly form Figure 13, there is 22% lower flue temperature in the closed condition in regenerative furnace. It can be concluded from these measurements, transformation of furnace to the regenerative furnace, decreased the energy losses due to the opening and closing furnace flap.

Another important issue in this transformation application is the fuel consumption to produce per unit of product. In Figure 14, it can be seen the fuel consumption ratio in m^3/ton unit for three type of melting burners in Haşcelik Kablo Co.

It can be seen in Figure 14; non-preheated furnace consumes 118.7 m^3 natural gas to produce one ton of product. This value is 91.8 m^3 in recuperative burner due to the preheating of inlet air with exchangers. On the other hand, in regenerative furnace, to produce one-ton product, only 66.6 m^3 of fuel is consumed. This the meaning of regenerative transformation of furnaces may decrease the fuel consumption up to 43%. The efficiency change of different furnaces structure can be shown as Figure 8.

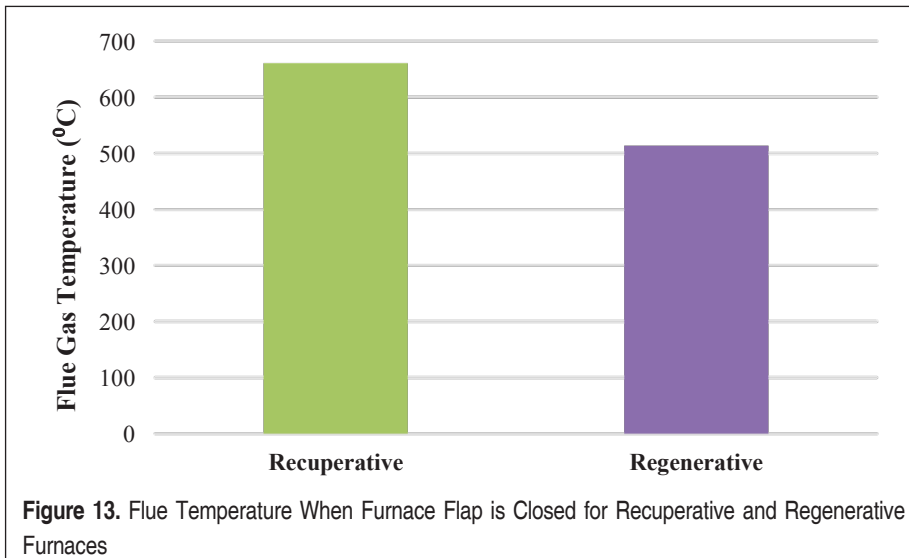

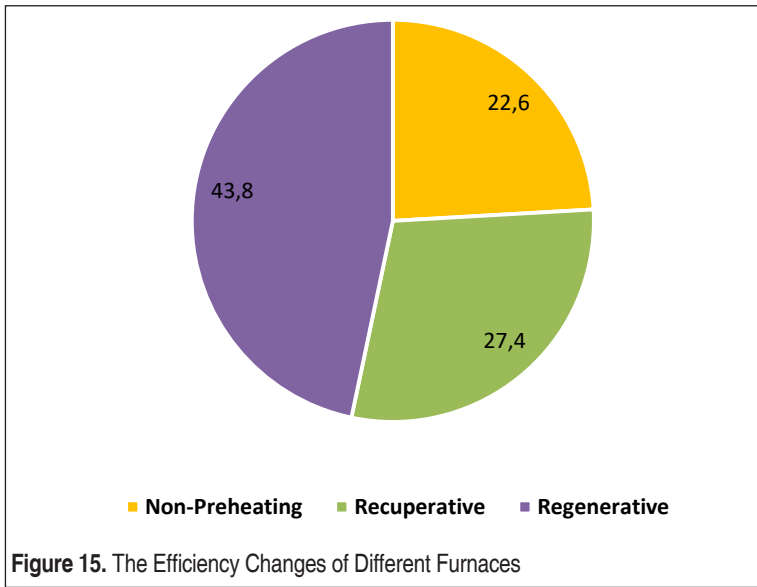
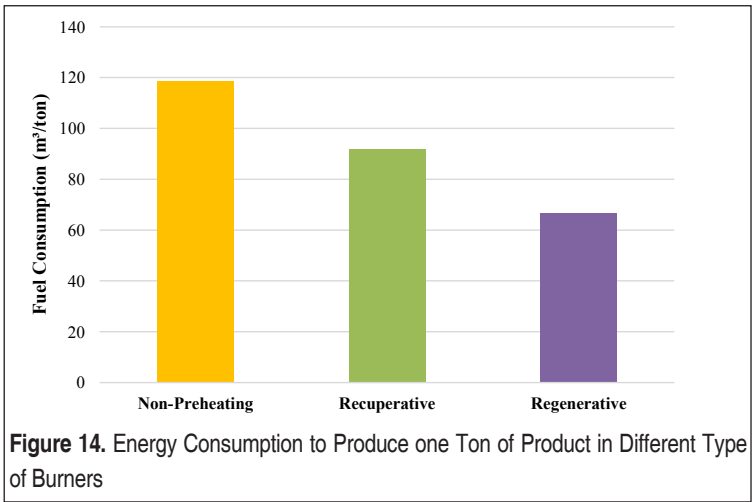

It can be clearly seen from Figure 15, in regenerative furnace efficiency value is almost two times higher than non-preheated furnace. It has a big benefit lowering the fuel costs and emission values of the system.

Moreover, the transformation process of this industrial melting furnace from recuperative to regenerative furnace is completed in 2018. In Figure 16, it can be seen the fuel consumption value of the same month (December 2018) of every year.

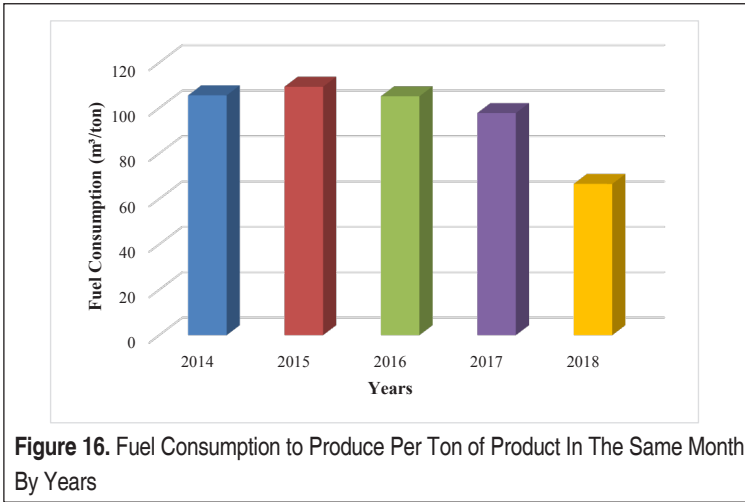

Figure 16. Fuel Consumption to Produce Per Ton of Product In The Same Month By Years

Table 2. Investment and Fuel Costs

Cost of Investment (\$)	280.000
Monthly Fuel Saving (m³)	61950
Annual Fuel Cost Saving (\$)	195.476

After transformation of furnace, the fuel consumption is decreased significantly by 2018. In the bar chart the highest consumption value is in 2015. The bar chart illustrates, there is 38.7% lower fuel consumption is obtained compared the 2015 values. Payback period of transformation investment will be very fast because of lower fuel consumption. In Table 1, the investment and fuel costs can be seen.

In this table average payback period (PP) can be shown as Eq. 3 as below:

$$PP = \frac{\text{Cost of investment}}{\text{Annual fuel saving cost}} \quad (3)$$

The PP time is calculated as 1.43 year. It means a superior saving of money and emissions for the Al melting facility.

4. CONCLUSION

In this study, energy recovering technologies are discussed in detail in terms of implement the regenerative furnaces an industrial facility. Several analyses are performed to compare non-preheated, recuperative, and regenerative furnaces as fuel consumption and flue temperature differences. According to the thermal camera images, heat losses from wall surface and other components are discussed in both furnaces. In regenera-



tive furnace, around the flue region, 23.4% lower temperature is obtained. It is very clear that regenerative systems increase system's efficiency with lower exhaust gas temperature. Moreover, fuel consumption is decreased to 43% in regenerative furnace compared to non-preheated furnace. According to CFD results 1654 J/kg enthalpy change is calculated for regeneration process of recuperative furnace to improve the efficiency of the system. Thus, CFD tools are important to calculate regenerative heat for the transformation process of industrial furnaces. In addition, according to facility measurements after transformation, 27.45% lower energy consumption obtained in regenerative furnace compared to recuperative furnace. PP time for the investment on regenerative furnace is calculated as 1.43 year.

ACKNOWLEDGEMENTS

The authors would like to thank the Turkish Science Ministry of Industry and Technology with grant number RDC.2017.03.02.

REFERENCES

1. **Greening, L.A., G. Boyd, and J.M. Roop**, 2007. Modeling of industrial energy consumption: An introduction and context, vol. 29, p. 599-608
2. **Hasanuzzaman, M., Rahim, N., Hosenuzzaman, M., Saidur, R., Mahbul, I., Rashid, M.** 2012. "Energy savings in the combustion based process heating in industrial sector". *Renewable and Sustainable Energy Reviews*, vol. 16, p. 4527-4536.
3. **Çomaklı, K., Terhan, M.** 2015. "Doğalgaz Yakıtlı Kazandan Çıkan Atık Baca Gazının Ekserji Analizi". *Mühendis ve Makina*, vol. 56, p. 58-64.
4. **Eyidoğan, M., Durmuş, K., Dursun, Ş., Taylan, O.** 2014. "Endüstriyel Tav Fırınlarında Enerji Tasarrufu Ve Emisyon Azaltım Fırsatları". *Gazi Üniversitesi Mühendislik-Mimarlık Fakültesi Dergisi*, vol. 29, p.
5. **Arslan, F.** 2016. "Kömür Yakıtlı Enerji Santrallerinde Birim Elektrik Enerjisi Üretim Maliyeti". *Mühendis ve Makina*, vol. 57, p. 49-55.
6. **Gielen, D., Taylor, P.** 2009. "Indicators for industrial energy efficiency in India". *Energy*, vol. 34, p. 962-969.
7. **Chunbao Charles, X., Cang, D.-q.** 2010. "A brief overview of low CO₂ emission technologies for iron and steel making". *Journal of Iron and Steel Research, International*, vol. 17, p. 1-7.
8. **Terhan, M., Çomaklı, K.** 2015. "Baca Gazı Atık Isısı ile Kazan Yakma Havasının Ön Isıtılmasının Fizibilitesi". *Mühendis ve Makina*, vol. 56, p. 56-63.
9. **Eyidogan, M., Kaya, D., Dursun, S., Taylan, O.** 2014. "Energy Saving And Emission Reduction Opportunities in an Industrial Annealing Furnaces". *Journal of the Faculty of Engineering and Architecture of Gazi University*, vol. 29, p. 735-743.



10. **Ertem, M., Şen, S., Akar, G., Pamukcu, C., Gurgen, S.** 2010. “Energy balance analysis and energy saving opportunities for Erdemir slab furnace# 3”. Energy Sources, Part A: Recovery, Utilization, and Environmental Effects, vol. 32, p. 979-994.
11. **Tütünoğlu, Y., Güven, A., Öztürk, İ. T.** 2012. “Cam temperleme fırınında enerji analizi”. TMMOB MMO, Mühendis Makina Dergisi, vol. 53, p. 55.
12. **Rafidi, N., Blasiak, W., Jewartowaski, M., Szewczyk, D.** 2005. “Increase of the effective energy from the radiant tube equipped with regenerative system in comparison with conventional recuperative System”. IFRF Combustion Journal, vol. p. 1-17.
13. **Schalles, D. G.** 2002. “The next generation of combustion technology for aluminum melting”. Bloom Engineering Company, Inc, vol. 5460, p.
14. **Siemens, F.**, Regenerative furnace, 1914, Google Patents.
15. **Baukal Jr, C. E.** 2003. “Industrial burners handbook”, CrC press, US.
16. **Bilgin, A.** 2006. “Kazanlarda enerji verimliliği ve emisyonlar”. Makina Mühendisleri Odası websitesi, http://www.mmo.org.tr/resimler/dosya_ekler/1673a38f02b5852_ek, Son Erişim Tarihi: 29.11.2020.
17. **Rafidi, N.** 2005. “Thermodynamic aspects and heat transfer characteristics of HiTAC furnaces with regenerators”. PhD Thesis, KTH, Stockholm.
18. **Jouhara, H., Khordehghah, N., Almahmoud, S., Delpech, B., Chauhan, A., Tassou, S. A.** 2018. “Waste heat recovery technologies and applications”. Thermal Science and Engineering Progress, vol.6, p. 268-289.