



A Comparison between IM and IPMSM with Same Stator Core for EV and Performance Analysis of IPMSM

Emin Tarik Kartal¹, Fatma Keskin Arabul^{2*}

¹ Yildiz Technical University, Faculty of Electrical and Electronics Engineering, Department of Electrical Engineering, Istanbul, Turkey (ORCID: 0000-0002-4966-7258), etkartal@yildiz.edu.tr

^{2*} Yildiz Technical University, Faculty of Electrical and Electronics Engineering, Department of Electrical Engineering, Istanbul, Turkey (ORCID: 0000-0002-9573-8440), keskin@yildiz.edu.tr

(First received 24 April 2022 and in final form 15 June 2022)

(DOI: 10.31590/ejosat.1108129)

ATIF/REFERENCE: Kartal, E.T. & Keskin Arabul, F. (2022). A Comparison between IM and IPMSM with Same Stator Core for EV and Performance Analysis of IPMSM. *European Journal of Science and Technology*, (38), 165-172.

Abstract

Electric motors are widely used since they are more efficient and environmentally friendly compared to internal combustion engines. Studies in the fields of electric motors and battery management systems etc. used in electric vehicles are increasing day by day. In this study, the design of the electric motor used in electric vehicles and performance analyzes of the motor are made. Accordingly, firstly, an induction motor design is carried out by considering the design parameters of the induction motor used in Tesla Model S. Then, by taking the stator core of this induction motor as a reference, an interior permanent magnet synchronous motor design, which is very common and advantageous in electric vehicles, is designed. By considering the air gap, magnet angle, magnet thickness, magnet width and magnet type parameters of this motor, the results of analyzes are evaluated in terms of efficiency and torque ripple. As a result of analyzes, efficiency of the final design has been improved by 4.78% compared to the reference induction motor. In addition, the torque ripple of the final design has been improved by 55.17% compared to the initial design of the interior permanent magnet synchronous motor.

Keywords: Motor Design, Finite Element Method, Interior Permanent Magnet Synchronous Motor, Electrical Vehicle.

Elektrikli Araçlar için Aynı Stator Gövdesine Sahip Asenkron Motor ile Gömülü Sürekli Mıknatıslı Senkron Motorun Karşılaştırılması ve Performans Analizi

Öz

Elektrik motorlarının, içten yanmalı motorlara kıyasla, daha verimli olmaları ve çevre dostu olmaları nedeniyle kullanımları yaygınlaşmıştır. Elektrikli araçlarda kullanılan elektrik motorları, batarya yönetim sistemleri vb. alanlarda çalışmalar gün geçtikçe artmaktadır. Bu çalışmada da elektrikli araçlarda kullanılacak elektrik motorunun tasarımı ve motorun performans analizleri yapılmıştır. Buna bağlı olarak, ilk önce Tesla Model S'de kullanılan asenkron motorun tasarım parametreleri göz önüne alınarak bir asenkron motor tasarımı yapılmıştır. Ardından, bu asenkron motorun stator gövdesi referans alınarak, elektrikli araçlarda kullanımı oldukça yaygın ve avantajlı olan gömülü sürekli mıknatıslı senkron motor tasarımı yapılmıştır. Bu motorun, hava aralığı, mıknatıs açısı, mıknatıs kalınlığı, mıknatıs genişliği ve mıknatıs tipi parametreleri ele alınarak verim ve tork dalgalılığı açısından analiz sonuçları değerlendirilmiştir. Analizler sonucunda, son tasarımın, referans asenkron motora göre verimi %4,78 oranında iyileştirilmiştir. Ayrıca elde edilen son tasarımın, ilk tasarımı yapılan gömülü sürekli mıknatıslı senkron motora göre tork dalgalılığı %55,17 oranında iyileştirilmiştir.

Anahtar Kelimeler: Motor Tasarımı, Sonlu Elemanlar Yöntemi, Gömülü Sürekli Mıknatıslı Senkron Motor, Elektrikli Araç.

* Corresponding Author: keskin@yildiz.edu.tr

1. Introduction

Considering the concern that fossil fuels will run out and their negative effects on the environment, and the importance of transportation in human life, instead of vehicles with internal combustion engines (ICE) working with petroleum and derivative fuels, electric vehicles (EVs) working with electrical energy and being environmentally friendly have begun to be developed (Keskin, 2014).

As a propulsion system in vehicles, ICE has been widely used from past to present for a long time. Since the structures of ICEs are complex, their efficiency is low, but the structures of electric motors (EM) are simpler and their efficiency is higher than ICEs (Un-Noor et al., 2017). In addition to being simpler and more reliable than ICE vehicles, EVs are more advantageous in many aspects such as operating performance, noise and vibration, gear shifting, efficiency and driving pleasure (Gürbüz & Kulaksiz, 2016).

In recent years, EV studies and applications are increasing day by day in the world. Design of electric motors for EV applications is also a popular research topic. As can be seen in Figure 1, electric motors used in EV applications are basically classified as: direct current (DC) motors, induction motors (IMs), switched reluctance motors (SRMs) and permanent magnet synchronous motors (PMSMs) (De Klerk & Saha, 2021; Hashemnia & Asaei, 2008a; Lulhe & Date, 2016; Nugraha et al., 2021; Patil & Dhamal, 2019; Pindoriya et al., 2018; Ramesh & Lenin, 2019; Zhang et al., 2018).

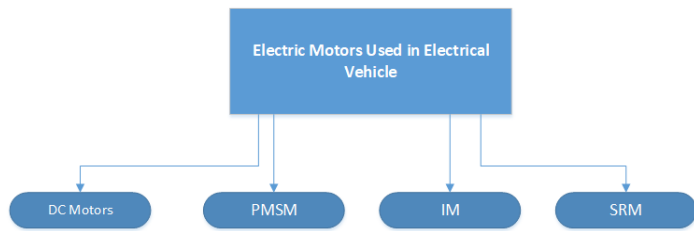

Figure 1. Electric motors used in EV

As a result of the researches, when the electric motors used in EVs are examined, PMSMs come to the fore. Since PMSMs have advantages such as high efficiency, high torque/power density ratio and power factor, low volume and weight, robust construction, high efficiency and reliability (Kurnaz Araz & Yilmaz, 2020).

PMSMs are alternating current motors in which magnets are used instead of windings in the rotor to create a magnetic field. The use of magnets is very advantageous for synchronous machines in terms of working principle, losses, maintenance requirement and design. When the previous studies on PMSMs are examined; It is seen that PMSMs are similar in structure to conventional DC motors, but unlike DC motors, permanent magnets are used instead of windings. Permanent magnet motors are divided into three according to their rotor shape as shown in Figure 2. These are spoke-type permanent magnet synchronous motor, interior permanent magnet synchronous motor (IPMSM) and surface mounted permanent magnet synchronous motor (Ahn et al., 2020).

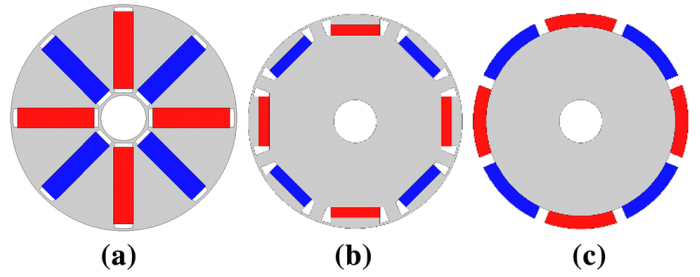

Figure 2. Permanent magnet motor types according to rotor shape a) Spoke type PMSM b) IPMSM c) Surface mounted PMSM (Ahn et al., 2020)

Spoke-type permanent magnet synchronous motors have disadvantages such as irreversible demagnetization and post-assembly magnetization of permanent magnets (Jeong et al., 2021; Seol et al., 2017). Surface mounted synchronous motors have the disadvantage that the magnets are subject to large centrifugal forces at high speeds. Therefore, the usage areas of these two types of motors are limited. In IPMSM, magnets are placed in slots made inside the rotor. Thus, in IPMSM type motors, since the magnets are embedded in the rotor, their resistance to centrifugal forces in high speed applications is very high (Xu et al., 2020b). In addition, their efficiency is higher than other magnet motors (Yang et al., 2015).

Today, IPMSMs are preferred in many electric vehicle applications (Cho et al., 2018; Choi & Bramerdorfer, 2022; Constantin et al., 2021; Xu et al., 2020a, 2021). However, in Tesla Model S, which was the best-selling electric vehicle of 2015 and 2016, induction motor was preferred (Thomas et al., 2020). In fact, although induction machines have several advantages such as robustness, easy maintenance or lower price, they have a lower power-to-weight ratio and are less efficient than PMSMs, which are more commonly used in the automotive industry (Hashemnia & Asaei, 2008b; Yang et al., 2015).

For this reason, in this study, IM design is made by considering the design parameters of the IM used in the Tesla Model S (Tang, 2012). Then, IPMSM design is made in the same stator core as the IM. Then, the effects of air gap, R_{rib} length, magnet thickness, magnet width and magnet material on the efficiency and torque ripple of IPMSM are investigated.

Following the introduction, Section 2 presents the topologies of reference IM and design parameter of IPMSM. Section 3 introduces model properties, results, and discussion of all various types of IPMSM models. Finally, the concluding remarks are presented in Section 4.

2. Methodology

In this study, transient analyses are carried out with the help of ANSYS Maxwell program. In this section, considering the geometrical properties of the stator and rotor core, IPMSM equations are presented.

$$P_{elc} = C \cdot D^2 \cdot L \cdot n_s \quad (1)$$

In Equation (1), P_{elc} is the input power, C is the utilization coefficient, D is the stator inner diameter, L is the rotor axial length and n_s is synchronous speed.

$$C = \frac{\pi^2}{\sqrt{2} \cdot 60} \cdot k_w \cdot A \cdot B_g \cdot 10^{-3} \left(\frac{kVA \cdot min}{m^3} \right) \quad (2)$$

In Equation (2), k_w is winding factor, A is circumferential current density and B_g is air gap flux density. A and B_g values can be selected with reference to well designed electrical machines with similar characteristics.

$$k_w = k_a \cdot k_d \quad (3)$$

According to the structure of the windings, k_d is winding distribution factor and k_a is winding pitch factor are calculated by using Equation 4 and Equation 5.

$$k_d = \frac{\sin\left(q \cdot \frac{\delta_{elc}}{2}\right)}{q \cdot \sin\left(\frac{\delta_{elc}}{2}\right)} \quad (4)$$

$$k_a = \cos\left(\frac{\beta}{2}\right) \quad (5)$$

In Equation (4) and (5) q is the number of slot per pole and phase, δ_{elc} is the electrical angle between the slots in one pole and β is electrical degree of shortening pitch. Winding distribution and shorting of coil pitch is done to reduce harmonics and copper cost.

$$E = \frac{2 \cdot \pi}{\sqrt{2}} \cdot k_w \cdot w_a \cdot f \cdot \phi \quad (6)$$

$$\phi = \frac{2}{\pi} \cdot B_g \cdot \tau_p \quad (7)$$

In Equation (6) E is the induced phase voltage, w_a is the number of turns per phase, f is frequency, ϕ is flux per pole. In Equation (7), τ_p is pole division. By using these two equations, the number of turns per phase is obtained. The flux value per pole should be corrected according to the calculated number of turns per phase.

In Equation (8), motor efficiency is calculated as follows:

$$\eta = \frac{P_{mec}}{P_{elc}} \quad (8)$$

where η is the efficiency; P_{mec} is the output power of the motor and P_{elc} is the input power of the motor.

$$\tau_{ripple} = \frac{\tau_{max} - \tau_{min}}{\tau_{avg}} \quad (9)$$

In Equation (9), torque ripple (τ_{ripple}) in percent is presented which is defined as the ratio of difference between maximum (τ_{max}) and minimum torque (τ_{min}) values to average torque (τ_{avg}) (Keskin Arabul et al., 2020).

3. Results and Discussion

In this section, general design parameters of analyzed IPMSMs with reference IM are presented. In addition, many IPMSMs are designed to have the same stator core as the referenced IM. While making these designs, no changes are made on the stator. When using the same stator, air gap length, magnet angle, magnet thickness, magnet width and magnet material are changed.

3.1. IM Model Details

This section presents the design parameters of the reference IM used in the EV (Tang, 2012). Analysis of motor is made using the ANSYS Maxwell program and the analysis is carried out in 2 dimensions (2D). The power of the IM is 225 kW and the torque is 430 Nm. In Table 1, design parameters of the IM obtained from ANSYS Maxwell 2D are shown. In addition, when the reference IM is modeled with the ANSYS Maxwell 2D, the mesh structure is shown in Figure 3(a) and the magnetic flux density distribution of the motor is shown in Figure 3(b).

Table 1. Design parameters of IM obtained from ANSYS Maxwell 2D

Parameter	Value
Pole Number	4
Stator core outer/inner diameter	254/156.8 mm
Rotor core outer/inner diameter	155.8/50 mm
Stack length	152 mm
Air gap length	0.5 mm
Stator/Rotor Slot Number	60/74
Efficiency	%93
Torque Ripple	%3.48

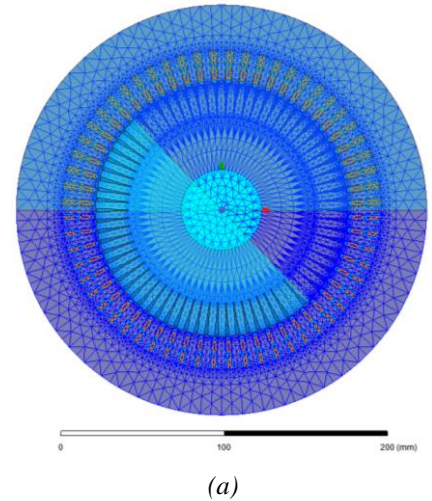

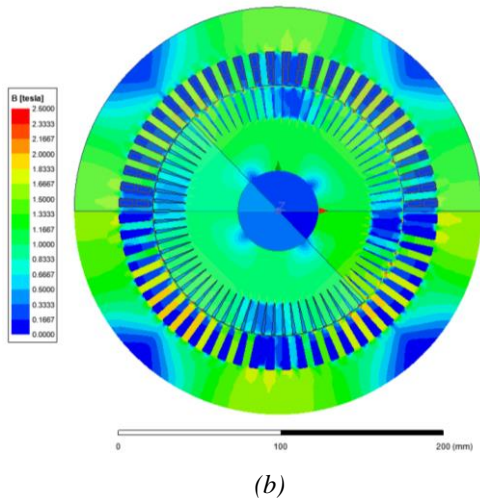

Figure 3. a) IM model b) Magnetic field density of IM

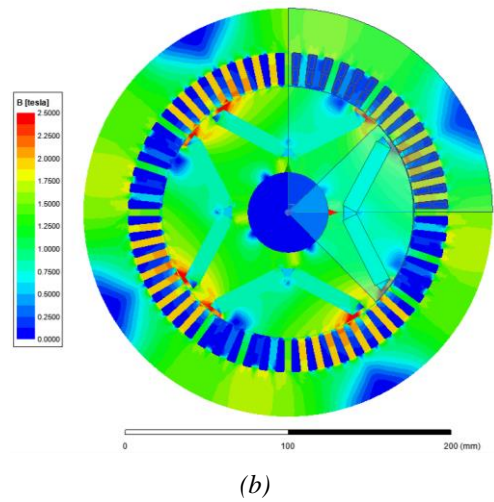

Figure 4. a) Initial IPMSM model b) Magnetic field density of initial IPMSM

3.2. Initial IPMSM Model Details

In this section, IPMSM model details are presented. IPMSM is designed to have the same stator core as the reference IM. ANSYS Maxwell 2D program is used to carry out the analysis. In Table 2, design parameters of the IPMSM obtained from ANSYS Maxwell 2D are shown. In Figure 4a, mesh structure and in Figure 4b, magnetic flux density distribution of IPMSM modeled in ANSYS Maxwell 2D are shown.

Table 2. Design parameters of IPMSM obtained from ANSYS Maxwell 2D

Parameter	Value
Pole Number	4
Stator core outer/inner diameter	254/156.8 mm
Rotor core outer/inner diameter	155.8/50 mm
Stack length	152 mm
Air gap length	0.5 mm
Stator Slot Number	60
Rotor Pole Type	V
Magnet Material	NdFeB N45
Efficiency	%97.74
Torque Ripple	%8.32

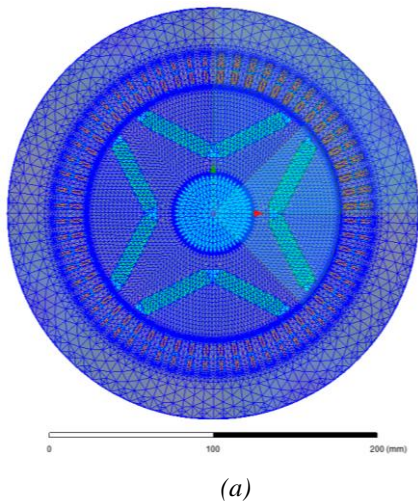

3.3. Analyzes of Air Gap Length

The air gap separating the rotor and stator greatly affects the performance of the IPMSM. It is known that even a very small air gap length has great effects on motor performances (Shokri et al., 2008).

In this section, the effects of air gap length on the efficiency and torque ripple of IPMSM are investigated. Therefore, the analyzes are made by increasing 0.1 mm from the minimum 0.5 mm air gap length to the maximum 1 mm air gap length. As a result of analyzes, the changes in motor efficiency and torque ripple with the change of air gap length are as shown in Figure 5.

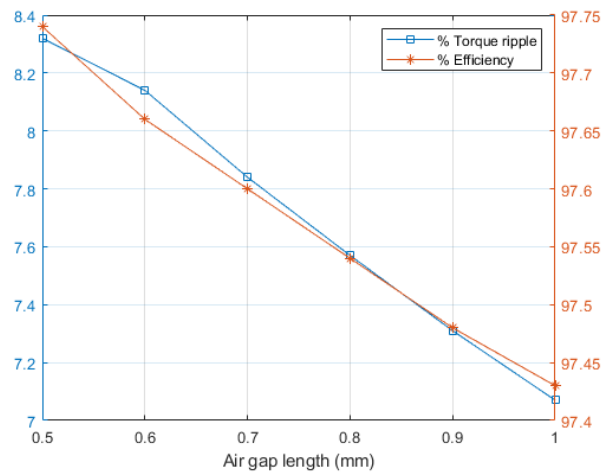

Figure 5. Effect of air gap length on motor efficiency and torque ripple

The air gap length for the motor selected as a reference is 0.5 mm. From the results of the analyzes performed by changing only the air gap length, 1 mm is chosen as the air gap to be used in the further analyzes for the motor. Although the efficiency of this model is lower than other analyzes results, it has minimum torque ripple. Thus, compared to the model with 0.5 mm air gap length, both ease of design is provided and 15.02% improvement is achieved in torque ripple. While the torque ripple is 8.32% in the model with 0.5 mm air gap, the torque ripple is measured as 7.07% as a result of the analysis performed for 1 mm air gap. There is an insignificant 0.3% decrease in efficiency is occurred.

In addition, it is seen in analyzes that the efficiency decreases as the air gap length increases.

3.4. Analyzes of R_{rib} Length

As given in the design parameters, V type pole structure is preferred in this design and improvement study. In Figure 6, the main geometric structures of this pole are indicated.

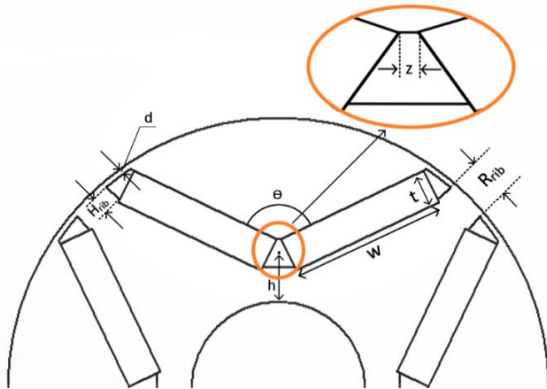

Figure 6. Geometric dimensions of IPMSM

In Figure 6, z is the distance of magnet pocket; d is the distance of magnet outer barrier to outer diameter of rotor; h is clearance from inner arc till point; θ is the angle between magnets belonging to the same pole; t is the thickness of the magnet; w is width of the magnet; H_{rib} is the length of the magnet barriers parallel to each other; R_{rib} is the distance between the magnet barriers of consecutive poles.

In this section, with the z , h and H_{rib} specified in the rotor geometry presented in Figure 6, the magnet thickness and width remain constant, R_{rib} changes, and accordingly, both the distance and angle values between the two magnets take different values. R_{rib} length between the two magnets, which is 15 mm in the initial IPMSM design, is simulated in this study to be a minimum of 5 mm and a maximum of 17 mm in increments of 1 mm. The efficiency and torque ripple-dependent performance analyzes of 13 different models simulated in this way are as shown in Figure 7.

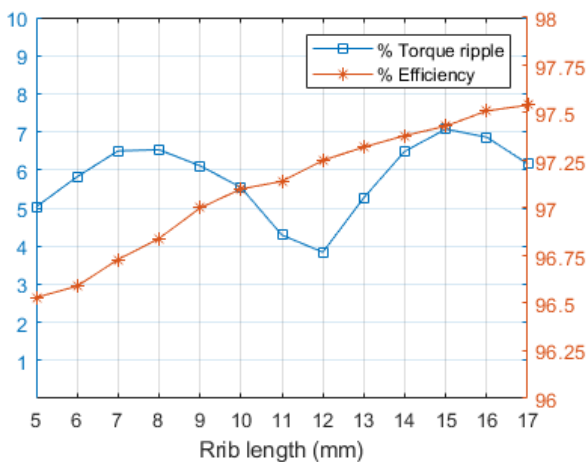

Figure 7. Effect of R_{rib} length on motor efficiency and torque ripple

As seen in Figure 7, among these designs, the model with the R_{rib} length of 12 has a minimum torque ripple. Torque ripple is 3.84% in this model. This model has a 53.85% improvement in torque ripple and a 0.5% decrease in efficiency compared to the initial IPMSM design. According to the model selected in Section 3.3, 45.69% improvement is achieved in torque ripple, while there is a 0.18% decrease in efficiency. For this reason, the R_{rib} length is chosen as 12 mm for the analysis studies in the next sections. In addition, as a result of analyzes, it is observed that the efficiency increased as the R_{rib} length increased.

3.5. Analyzes of Magnet Thickness

After the torque ripple improvement studies for air gap and R_{rib} length parameters, in this section, the effects of magnet thickness on torque ripple and efficiency are examined.

The magnet thickness of the model selected in Section 3.4 is 10 mm. In Figure 8, efficiency and torque ripple performances of 9 different models, including the model selected in Section 3.4, are presented depending on the magnet thickness.

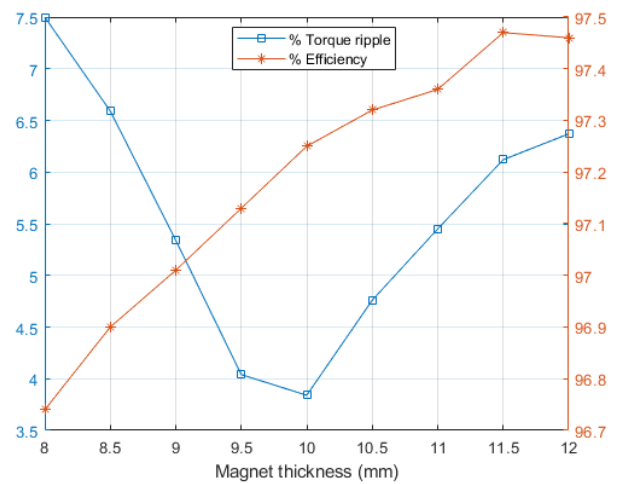

Figure 8. Effect of magnet thickness on motor efficiency and torque ripple

As seen in Figure 8, the magnet thickness is examined in 0.5 mm increments between 8 mm and 12 mm, taking into account the rotor geometry. As a result of analyzes, it is seen that the magnet thickness of 10 mm is the most suitable for torque ripple.

3.6. Analyzes of Magnet Width

Another parameter that is important for torque ripple and efficiency within the rotor geometry is the magnet width. After determining that the magnet thickness in the initial IPMSM design has minimum torque ripple in the previous section, this section examines the effects of magnet width on torque ripple and efficiency.

d is the distance of magnet outer barrier to outer diameter of rotor, shown in Figure 6, is kept constant at 2 mm and the magnet width is determined as a minimum of 43 mm and a maximum of 46 mm, considering the rotor geometry in analyzes. Thus, torque ripples and efficiencies of 7 different models, depending on magnet width, are presented in Figure 9.

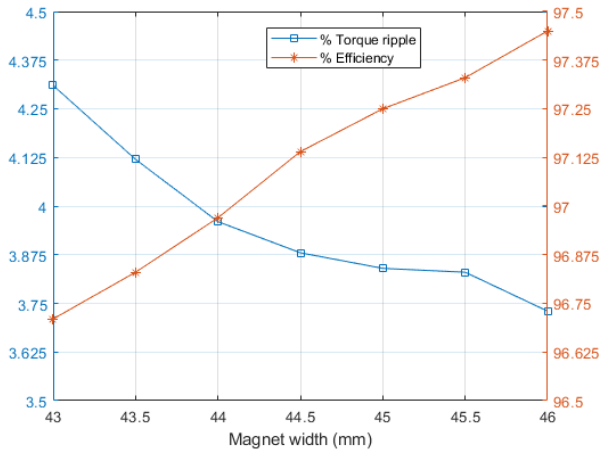

Figure 9. Effect of magnet width on motor efficiency and torque ripple

In analyzes for magnet width in 0.5 mm increments from Figure 9, it is seen that the torque ripple of 46 mm magnet width is minimum. The torque ripple of this model is 3.73%. The torque ripple of this model has been improved by 55.17% compared to the initial IPMSM design. In addition, a 2.9% improvement is achieved in torque ripple compared to the model selected in the previous section. The efficiency of this model is 97.45%, and it has the highest efficiency value in analyzes for magnet width. This efficiency value is 0.3% less compared to the initial IPMSM design. Furthermore, according to the results of analyzes made in this section, the efficiency increases as the magnet width increases.

3.7. Analyzes of Magnet Materials

In this section, the effects of different magnet materials on motor performance are examined. The types of magnets used in analyzes are those that can be easily procured in the supply chain. These magnet types are used in applications that require high performance such as many motors, generators, actuators, sensors and driver systems, especially IPMSM motors. These are 35E-Samarium Cobalt, AlNiCo-6-Sintered, AlNiCo-6-Cast, AlNiCo-9 and NdFeb-N45 which is used in the initial design. Ferrite magnets are another type of magnet used in IPMSMs. However, the motors used in electric vehicles are expected to have high power and torque density with low volume and weight. Considering this situation; ferrite magnets are not preferred in this study due to the low permanent flux density in ferrite magnets and the need for more volume to produce the same flux in the same air gap compared to other magnets. Instead, AlNiCo is preferred along with NdFeB and SmCo, which are rare earth magnets with higher energy densities, in analyzes. Figure 10 shows the graphs of torque ripples and efficiencies depending on the magnet types of the model selected in section 3.6.

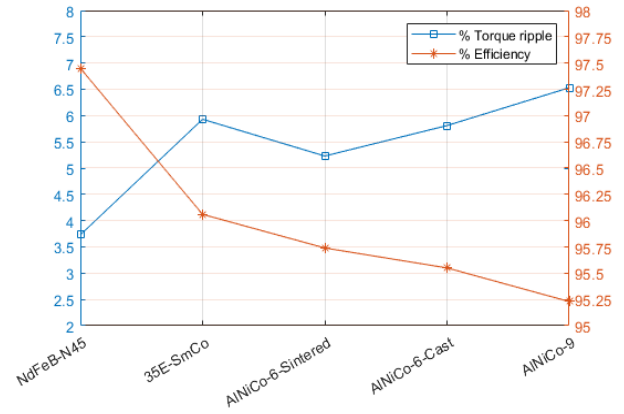

Figure 10. Effect of magnet materials on motor efficiency and torque ripple

As can be seen from Figure 10, NdFeB, the rare earth element magnet with the highest energy density, has the best performance in terms of torque ripple and efficiency. When compared in terms of efficiency, NdFeB is followed by SmCo, which has lower energy density but better heat resistance. The use of high-energy permanent magnets such as SmCo or NdFeB in IPMSMs keeps the air gap induction higher than the wound rotor motors and eliminates copper losses in the rotor windings, resulting in higher efficiency than a synchronous motor of the same power. In addition, the motor dimensions are considerably smaller (Texas Instruments, 1997). The energy density of other AlNiCo types used in analyzes is lower than rare earth magnets. As can be seen in Figure 10, AlNiCo series magnets have the lowest performance among the magnets used in terms of both efficiency and torque ripple. As a result of analyzes made, in this study, NdFeB is preferred as the magnet material in final design IPMSM.

4. Conclusion

In this study, design, analyzes and improvement studies of IPMSM for electric vehicles are carried out. Firstly, the IM used in the S60 model, which entered the automotive industry effectively with Tesla brand and achieved good sales, is modeled and analyzed. As a result of the analysis, the efficiency of the IM is 93% and the torque ripple is 3.48%. Secondly, IPMSM design is made with reference to the stator core of this IM. It is seen that the efficiency and the torque ripple of the initial designed IPMSM is higher than the IM. For this reason, it is aimed to reduce the torque ripple of IPMSM, which has higher efficiency than IM, depending on the design parameters. Performance comparisons and improvement studies are carried out on parameters that have important effects on efficiency and torque ripple, such as air gap, Rib length, magnet thickness, magnet width and magnet type. As a result of the analyzes; depending on the change of these parameters, an IPMSM model with 97.45% efficiency and 3.73% torque ripple is obtained. In addition, the efficiency of IPMSM which has the same stator core with IM is higher than efficiency of IM. In conclusion, the torque ripple of final designed IPMSM has been improved by 55.17% compared to the initial IPMSM design and catches up torque ripple value of IM. In future studies, motor control techniques will be applied and simulation studies will be carried out by creating a mathematical model of the motor.

References

- Ahn, H., Park, H., Kim, C., & Lee, H. (2020). A Review of State-of-the-art Techniques for PMSM Parameter Identification. *Journal of Electrical Engineering and Technology*, 15(3), 1177–1187. <https://doi.org/10.1007/S42835-020-00398-6/TABLES/1>
- Cho, S. K., Jung, K. H., & Choi, J. Y. (2018). Design Optimization of Interior Permanent Magnet Synchronous Motor for Electric Compressors of Air-Conditioning Systems Mounted on EVs and HEVs. *IEEE Transactions on Magnetics*, 54(11). <https://doi.org/10.1109/TMAG.2018.2849078>
- Choi, G., & Bramerdorfer, G. (2022). Comprehensive Design and Analysis of an Interior Permanent Magnet Synchronous Machine for Light-Duty Passenger EVs. *IEEE Access*, 10, 819–831. <https://doi.org/10.1109/ACCESS.2021.3137897>
- Constantin, A. I., Dumitru, C., Tudor, E., Vasile, I., & Arsene, M. (2021, May). Studies related to the optimization of an interior permanent magnet synchronous machine designed for the electric vehicles. *2021 International Conference on Applied and Theoretical Electricity, ICATE 2021 - Proceedings*. <https://doi.org/10.1109/ICATE49685.2021.9465051>
- De Klerk, M. L., & Saha, A. K. (2021). A Comprehensive Review of Advanced Traction Motor Control Techniques Suitable for Electric Vehicle Applications. *IEEE Access*, 9, 125080–125108. <https://doi.org/10.1109/ACCESS.2021.3110736>
- Gürbüz, Y., & Kulaksız, A. A. (2016). Elektrikli Araçlar ile Klasik İçten Yanmalı Motorlu Araçların Çeşitli Yönlerden Karşılaştırılması. *Gümüşhane Üniversitesi Fen Bilimleri Dergisi*, 6(2), 117–125. <https://doi.org/10.17714/GUFBED.2016.06.011>
- Hashemnia, N., & Asaei, B. (2008a, September). Comparative study of using different electric motors in the electric vehicles. *Proceedings of the 2008 International Conference on Electrical Machines, ICEM'08*. <https://doi.org/10.1109/ICELMACH.2008.4800157>
- Hashemnia, N., & Asaei, B. (2008b). Comparative study of using different electric motors in the electric vehicles. *Proceedings of the 2008 International Conference on Electrical Machines, ICEM'08*, 1–5. <https://doi.org/10.1109/ICELMACH.2008.4800157>
- Jeong, M.-J., Lee, K.-B., Pyo, H.-J., Nam, D.-W., Kim, W.-H., Jeong, M.-J., Lee, K.-B., Pyo, H.-J., Nam, D.-W., & Kim, W.-H. A. (2021). A Study on the Shape of the Rotor to Improve the Performance of the Spoke-Type Permanent Magnet Synchronous Motor. *Energies*, 14(13), 3758. <https://doi.org/10.3390/EN14133758>
- Keskin Arabal, F., Senol, I., & Oner, Y. (2020). Performance Analysis of Axial-Flux Induction Motor with Skewed Rotor. *Energies*, 13(19), 4991. <https://doi.org/10.3390/EN13194991>
- Keskin, F. (2014). *Yakut pilli-bataryalı hibrid bir elektrikli araçta enerji yönetiminin sağlanması*. Yıldız Technical University.
- Kurnaz Araz, H., & Yilmaz, M. (2020). Elektrikli araçlar için mıknatıs oranı ve moment titreşimi azaltılmış yüksek verimli sürekli mıknatıslı senkron motor tasarım süreci ve gerçekleştirilmesi. *Journal of the Faculty of Engineering and Architecture of Gazi University*, 35(2), 1089–1109.
- Lulhe, A. M., & Date, T. N. (2016). A technology review paper for drives used in electrical vehicle (EV) & hybrid electrical vehicles (HEV). *2015 International Conference on Control Instrumentation Communication and Computational Technologies, ICCICCT 2015*, 632–636. <https://doi.org/10.1109/ICCICCT.2015.7475355>
- Nugraha, Y. U., Asfani, D. A., Yulistya Negara, I. M., Aziz, M., & Yuniarto, M. N. (2021). Technology Review of Electric Motor for Hybrid-Electric Vehicle. *IEEE Region 10 Annual International Conference, Proceedings/TENCON, 2021-December*, 777–781. <https://doi.org/10.1109/TENCON54134.2021.9707371>
- Patil, M. S., & Dhamal, S. S. (2019). A Detailed Motor Selection for Electric Vehicle Traction System. *Proceedings of the 3rd International Conference on I-SMAC IoT in Social, Mobile, Analytics and Cloud, I-SMAC 2019*, 679–684. <https://doi.org/10.1109/I-SMAC47947.2019.9032616>
- Pindoriya, R. M., Rajpurohit, B. S., Kumar, R., & Srivastava, K. N. (2018). Comparative analysis of permanent magnet motors and switched reluctance motors capabilities for electric and hybrid electric vehicles. *2018 IEEMA Engineer Infinite Conference, ETechNXT 2018*, 1–5. <https://doi.org/10.1109/ETECHNXT.2018.8385282>
- Ramesh, P., & Lenin, N. C. (2019). High Power Density Electrical Machines for Electric Vehicles-Comprehensive Review Based on Material Technology. *IEEE Transactions on Magnetics*, 55(11). <https://doi.org/10.1109/TMAG.2019.2929145>
- Seol, H. S., Jeong, T. C., Jun, H. W., Lee, J., & Kang, D. W. (2017). Design of 3-Times Magnetizer and Rotor of Spoke-Type PMSM Considering Post-Assembly Magnetization. *IEEE Transactions on Magnetics*, 53(11), 1–5. <https://doi.org/10.1109/TMAG.2017.2707593>
- Shokri, S., Ardebili, M., & Izadfar, H. R. (2008). Air gap length evaluation in interior permanent magnet synchronous motor. *European Journal of Scientific Research*, 19(4), 691–699.
- Tang, Y. (2012). *Induction motor lamination design* (Patent No. US8154167B2). United States Patent. <https://patents.google.com/patent/US8154167>
- Texas Instruments. (1997). *Digital Signal Processing Solution for Permanent Magnet Synchronous Motor*.
- Thomas, R., Garbuio, L., Gerbaud, L., & Chazal, H. (2020). Modeling and design analysis of the Tesla Model S induction motor. *Proceedings - 2020 International Conference on Electrical Machines, ICEM 2020*, 495–501. <https://doi.org/10.1109/ICEM49940.2020.9270646>
- Un-Noor, F., Padmanaban, S., Mihet-Popa, L., Mollah, M. N., & Hossain, E. (2017). A Comprehensive Study of Key Electric Vehicle (EV) Components, Technologies, Challenges, Impacts, and Future Direction of Development. *Energies*, 10(8), 1217. <https://doi.org/10.3390/EN10081217>

- Xu, Y., Ai, M., Xu, Z., Liu, W., & Wang, Y. (2020a, October). Analysis of Interior Permanent Magnet Synchronous Motor Used for Electric Vehicles Based on Power Matching and Driving Conditions. *2020 IEEE International Conference on Applied Superconductivity and Electromagnetic Devices, ASEMD 2020*. <https://doi.org/10.1109/ASEMD49065.2020.9276276>
- Xu, Y., Ai, M., Xu, Z., Liu, W., & Wang, Y. (2020b, October 16). Analysis of Interior Permanent Magnet Synchronous Motor Used for Electric Vehicles Based on Power Matching and Driving Conditions. *2020 IEEE International Conference on Applied Superconductivity and Electromagnetic Devices, ASEMD 2020*. <https://doi.org/10.1109/ASEMD49065.2020.9276276>
- Xu, Y., Ai, M., Xu, Z., Liu, W., & Wang, Y. (2021). Research on Interior Permanent Magnet Synchronous Motor Based on Performance Matching of Electric Bus. *IEEE Transactions on Applied Superconductivity*, *31*(8). <https://doi.org/10.1109/TASC.2021.3091062>
- Yang, Z., Shang, F., Brown, I. P., & Krishnamurthy, M. (2015). Comparative study of interior permanent magnet, induction, and switched reluctance motor drives for EV and HEV applications. *IEEE Transactions on Transportation Electrification*, *1*(3), 245–254. <https://doi.org/10.1109/TTE.2015.2470092>
- Zhang, X., Zeng, L., & Pei, R. (2018). Designing and Comparison of Permanent Magnet Synchronous Reluctance Motors and Conventional Motors in Electric Vehicles. *ICEMS 2018 - 2018 21st International Conference on Electrical Machines and Systems*, 202–205. <https://doi.org/10.23919/ICEMS.2018.8549102>