Araştırma Makalesi / Research Article

Balance Control of a Flywheel Inverted Pendulum by Fuzzy Logic Controller

Hüseyin Oktay Erkol¹, Cemil Közkurt^{2*}

¹ Bandırma Onyedü Eylül University, Faculty of Engineering and Natural Sciences, Department of Electrical Engineering, Bandırma, Balıkesir, Turkey,

Orcid ID: <https://orcid.org/0000-0002-3595-175X>, herkol@banu.edu.tr

² Bandırma Onyedü Eylül University, Faculty of Engineering and Natural Sciences, Department of Transportation Engineering, Bandırma, Balıkesir, Turkey,

Orcid ID: <https://orcid.org/0000-0003-1407-9867>, ckozokurt@banu.edu.tr

Geliş/ Received: 10.11.2022;

Kabul / Accepted: 27.02.2023

ABSTRACT: In this study, a flywheel inverted pendulum was modeled as simulation. The model controlled by fuzzy logic and PID controller for comparison. Fuzzy logic controllers were designed using triangular and Gaussian membership functions and various methods that are "and", "implication" and "aggregation". All gains from fuzzy logic controllers and PID were tuned by the trial-and-error method. The best performance was obtained by fuzzy logic controller that uses a triangular membership function and "prob/probor" functions. The results were evaluated in terms of three phenomena. In terms of Settling Time and Maximum Overshoot, Fuzzy Triangle MF with 0.15 s and 0 degrees, respectively, and PID and Fuzzy Triangle MF models with 0 degrees in terms of Steady-State error achieved the best success. In addition, the robustness of the control system was tested by applying two different types of disturbance inputs, random and impulse. The results show that fuzzy logic is a good alternative for balance control of a flywheel inverted pendulum, but PID has an acceptable performance.

Keywords: Flywheel Inverted Pendulum, Balance Control, Fuzzy Logic, Simulation.

*Sorumlu yazar / Corresponding author: ckozokurt@banu.edu.tr

Bu makaleye atıf yapmak için /To cite this article

Erkol, H.O., Közkurt, C. (2023). Balance Control of a Flywheel Inverted Pendulum by Fuzzy Logic Controller. Journal of Materials and Mechatronics: A (JournalMM), 4(1), 147-160.

1. INTRODUCTION

Inverted pendulum is a popular and important tool in control theory. There are many different types of inverted pendulum in literature. Classic inverted pendulum systems are designed to move on a fixed linear mechanism. Some of others are two-wheeled inverted pendulums (Nawawi et al., 2008; Wasiwitono et al., 2021; Wu et al., 2012) and one-wheel inverted pendulums (Han et al., 2014; Moghadam and Marshall, 2021). They can move each direction on a two-dimensional surface by the wheels. During the movement, the body acts as an inverted pendulum and it must be balanced by the horizontal forces produced by the motion of the base of the pendulum. Another one is flywheel inverted pendulum (Andrievsky, 2011; Meyer et al., 2009; Olivares and Albertos, 2013). It is fixed on a horizontal surface by a rotational joint and has a flywheel on the top of the body. It can also have two degrees of freedom like Cubli (Bobrow et al., 2020; Gajamohan et al., 2012). Cubli is a robot in the form of a cube and it can balance on any one of its corners.

An inverted pendulum system has a nonlinear characteristic and balance control is a difficult process. Many times, controllers are designed using the linearized models of the system. Many types of controllers have been implemented to inverted pendulums. Jain et al. designed an inverted pendulum system and used PID controllers to stabilize the pendulum and control the position (Jain et al., 2013). They also used particle swarm optimization algorithm to tune the PID coefficients. Conventional methods for tuning the PID parameters are based on trial-and-error method. With optimization algorithms, the same process can be completed in a shorter time.

Linear quadratic regulator (LQR) and full-state feedback (FSF) are other control methods that can be used for an inverted pendulum. Razmjoooy and Alikhani used LQR and FSF techniques and made a performance comparison (Razmjoooy et al., 2014). The results showed that LQR has a better performance; because of which it is an optimal control technique of pole placement.

Similar studies are made for two wheel inverted pendulum, too. Villacrés et al. made a comparative study for controlling a two wheel inverted pendulum (Villacrés et al., 2016). PID controller, LQR and sliding mode control (SMC) are compared in the study. The results showed that SMC has the best performance and PID is an easy tunable controller. In another study, line tracking control of a two wheel inverted pendulum was made using visual feedback (Hatada et al., 2022).

Fractional order controllers are another option to control an inverted pendulum. There are various studies which are used fractional PID controllers for inverted pendulum, also include comparisons between PID controllers and fractional PID controllers (Mishra and Chandra, 2014; Mondal and Dey, 2022; Wang et al., 2016). They all reported that both of the PID and fractional PID had quite acceptable performance, but fractional PID was more robust.

In this study, a flywheel inverted pendulum model that is linearized is controlled by fuzzy logic controller. A controller is designed for high performance by examining the effects of the fuzzy logic controller parameters. The designed controller is also compared to a conventional PID controller.

2. FUZZY LOGIC CONTROL

Fuzzy logic is one of the popular tools in control theory. It can be used to control linear or non-linear systems. A fuzzy logic controller can have single-input or multi-input. Among multi-input fuzzy controllers, two-input ones are more preferred in terms of sensor and computational cost. The inputs are generally the error of system state which must be controlled and the derivative of it. The first step of a fuzzy logic control is fuzzification. In this step, the input data are converted into fuzzy data or membership functions. The second step is fuzzy inference process, and membership functions

and predefined rules are combined to derive fuzzy output. The fuzzy rules or rule table which include the all possible combination of inputs and outputs are specific to the system, and must be prepared by the help of an expert (Özmen and Közkurt, 2021). The last step of the fuzzy logic control is defuzzification. In this step, fuzzy outputs are calculated using different methods such as center of sums (COS), center of gravity (COG), weighted average method or maxima methods. The outputs are applied to the system and the output error which is the input of the fuzzy logic controller is calculated again. Many times, the inputs and the outputs of a fuzzy logic controller need a gain value many times. The gains have an important effect on the control performance of the fuzzy logic controller and they can be selected by trial-and-error method. Detailed information about fuzzy logic control can be found in (Bai and Wang, 2006; Tavana and Hajipour, 2019).

3. FLYWHEEL INVERTED PENDULUM

Inverted pendulum is popular system, which is naturally nonlinear and unstable, in control theory. Inverted pendulum balance researches are basically made on an inverted pendulum on a cart and the aim is balancing the pendulum by moving the cart (Erkol, 2017; Mishra and Chandra, 2014; Niemann and Poulsen, 2003). The Inverted pendulum system used in this study has different structure based on a flywheel (Gajamohan et al., 2012; Huang et al., 2022; Prutskii et al., 2022). A simplified drawing of the system is given in Fig. 1. The system is fixed on the ground by a rotating joint and a flywheel is placed on top of the pendulum. When the flywheel is turning, a reaction torque becomes on the vertical plane. The direction of the reaction torque changes depending on the turning direction of the flywheel. The reaction torque also decreases or increase with the speed of the flywheel. In this way, inverted pendulum balance can be controlled by adjusting the flywheel speed and changing the turning direction. It means the input of the system is the torque driven by the flywheel.

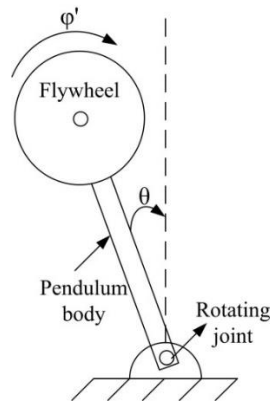

Figure 1. Basic structure of the flywheel inverted pendulum,0

The differential equations of the system can be derived using Euler-Lagrange method. The equations of the system given in Fig. 1 is given in equation 1-4 (Ruan and Wang, 2010). I_1 and I_2 are the inertia of the pendulum and flywheel, m_1 and m_2 are the weights of the pendulum and flywheel, f_1 and f_2 are the friction factors, g is the gravitational constant and l_1 is the pendulum length.

$$(a + I_2^2)\ddot{\theta} + I_2\ddot{\phi} = b\sin\theta - b_1\dot{\theta} \quad (1)$$

$$I_2(\ddot{\theta} + \ddot{\phi}) = u - b_2\dot{\phi} \quad (2)$$

$$a = m_1 l^2 + 4m_2 l^2 + I_1 \quad (3)$$

$$b = (m_1 + 2m_2)gl \quad (4)$$

When the θ is small enough, the equations can be linearized as given in equation 5-6 and the state space equation can be obtained as in equation 7 (Ruan and Wang, 2010). The system parameters are given in Table 1.

$$(a + I_2^2)\ddot{\theta} + I_2\ddot{\phi} = b\theta - f_1\dot{\theta} \quad (5)$$

$$I_2(\ddot{\theta} + \ddot{\phi}) = u - f_2\dot{\phi} \quad (6)$$

$$\begin{bmatrix} \dot{\theta} \\ \ddot{\phi} \\ \dot{\theta} \\ \ddot{\phi} \end{bmatrix} = \begin{bmatrix} 0 & 1 & 0 & 0 \\ \frac{b}{a} & -\frac{f_1}{a} & 0 & \frac{f_2}{a} \\ 0 & 0 & 0 & 1 \\ -\frac{b}{a} & \frac{f_1}{a} & 0 & -f_2 \frac{a+I_2}{aI_2} \end{bmatrix} \begin{bmatrix} \theta \\ \dot{\theta} \\ \phi \\ \dot{\phi} \end{bmatrix} + \begin{bmatrix} 0 \\ -\frac{1}{a} \\ 0 \\ \frac{a+I_2}{aI_2} \end{bmatrix} \tau \quad (7)$$

Table 1. System Parameters

Symbol	Value	Unit
L	0.25	m
m_1	1.2	kg
m_2	0.46	kg
I_1	2.504×10^{-2}	Kgm ²
I_2	3.423×10^{-3}	Kgm ²
f_1	9.4×10^{-3}	Nm/V
f_2	3×10^{-4}	Nm.s

4. EXPERIMENTAL STUDY BASED ON SIMULATED MODELS

In this study, a flywheel pendulum was modeled and a fuzzy logic controller was designed to balance the pendulum. All study was made by simulations using MATLAB/Simulink program. Firstly, the system was controlled by a PID controller to see the performance and make comparisons. The structure of the PID controlled system is given in Fig. 2. The PID was tuned by auto tune property of the MATLAB, and then the controller performance was improved by manual tuning. All settling time and overshoot values were calculated with 2% tolerance. The system outputs are given in Fig. 3. The settling time (S.T.) and the maximum overshoot (M.O.S.) of the θ output are respectively 1.091s and 0.212° when the auto tune is used. The performance can be improved by manual tuning after auto tuning. The S.T. and M.O.S. are respectively 0.227s and 0.146° for the manually improved system, respectively.

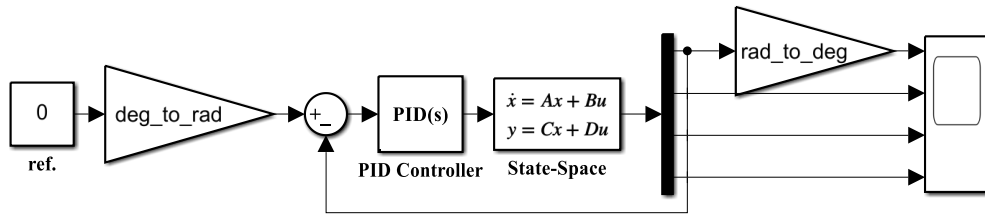

Figure 2. Block diagram of the system controlled by PID

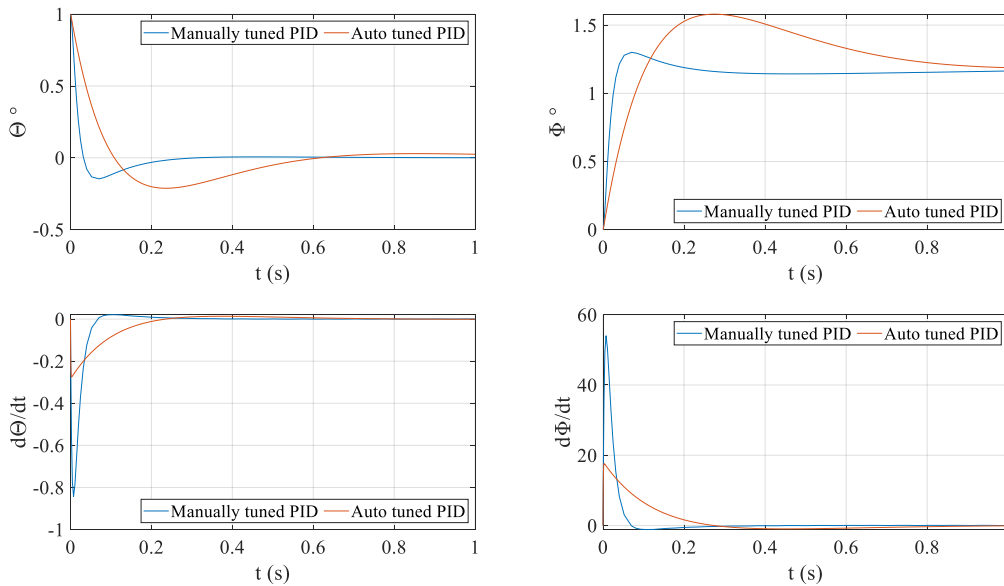

Figure 3. Output graphs of the PID controlled system

4.1. Fuzzy Models

The main aim of the study is to design a fuzzy logic controller for a better performance than classical methods like PID. The simulation design for fuzzy logic control is given in Fig. 4. The designed controller has two inputs; the error, and the derivative of the error. Both of the inputs have gains (K_e and K_{de}), and the controller output has also a gain (K_{out}). It should be noticed that K_{out} has a negative sign because of the rule table and characteristic of the system. All of the gains have important effects on the controller performance. The used rule table is given in Table 2.

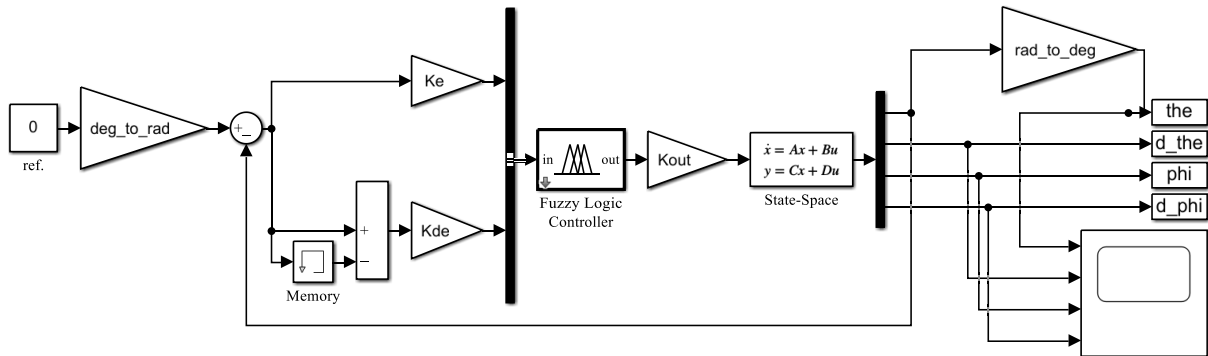

Figure 4. Block diagram of the system controlled by fuzzy logic controller

Table 2. The rule table of the fuzzy logic controller

θ' \ θ	NB	NM	NS	ZO	PS	PM	PB
NB	NB	NB	NM	NM	NS	NS	ZO
NM	NB	NM	NM	NS	NS	ZO	PS
NS	NM	NM	NS	NS	ZO	PS	PS
ZO	NM	NS	NS	ZO	PS	PS	PM
PS	NS	NS	ZO	PS	PS	PM	PM
PM	NS	ZO	PS	PS	PM	PM	PB
PB	ZO	PS	PS	PM	PM	PB	PB

Two types of membership function (MF) were used. Different “And”, “Or”, “Implication” and “Aggregation” methods were used to see their effects on the performance. Firstly, triangular MF given in Fig. 5 was used. Input and output ranges of the functions were determined between “-1” and “1”. Inputs and outputs were scaled by the gains of K_e , K_{de} and K_{out} . “And” method and “implication” methods were chosen as “min”. “Or” method and “aggregation” methods were chosen as “max”. Selected methods can be seen in Table 3.

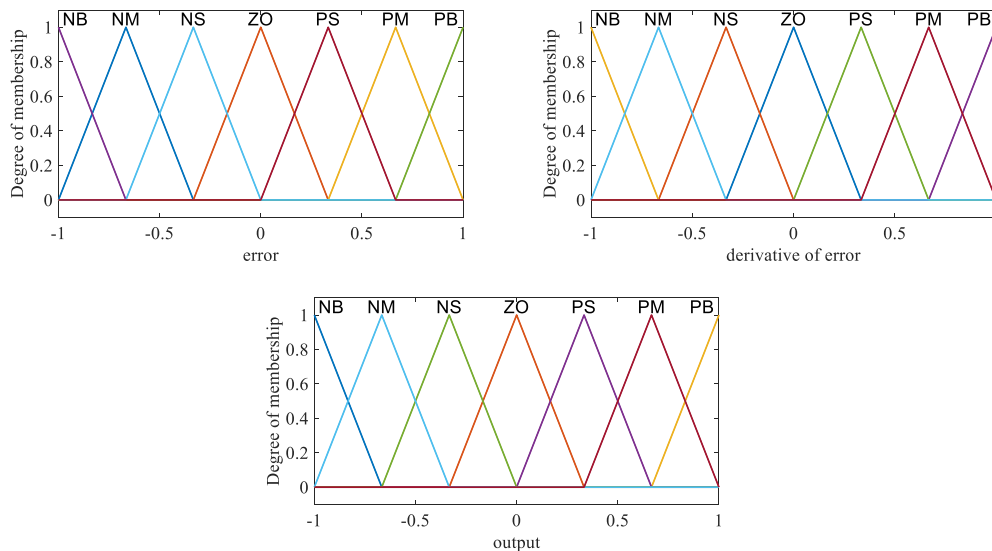

Figure 5. Triangle membership functions of error and derivative of error inputs and the output

Table 3 Parameters of the fuzzy logic controllers

Parameters	Membership Functions	
	Triangle	Gaussian
And Method	min	prod
Or Method	max	max
Implication	min	prod
Aggregation	max	probor
Defuzzification	centroid	centroid

Then the gains were manually tuned for the best performance. Firstly, K_e , K_{de} and K_{out} were selected as respectively 5, 5, and 200, respectively. Initial θ angle was selected as 1° . The system reached to the reference (0°) in more than 0.5s. The system output had also much oscillation. The graphs of system outputs are given in Fig. 6.

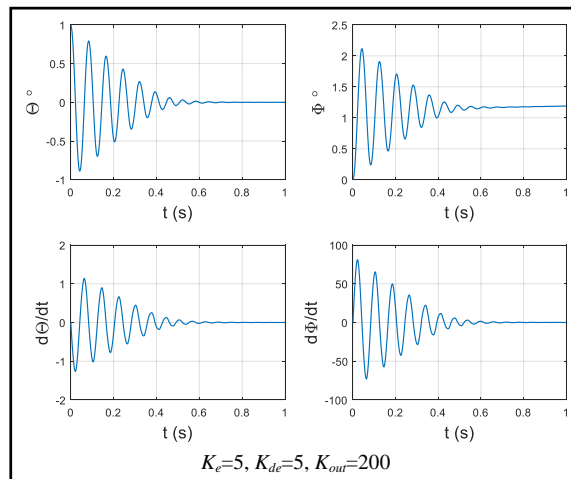

Figure 6. System outputs of the fuzzy logic controller which has triangle MF

K_{out} was changed to improve system performance. The system had more settling time when K_{out} was decreased, and it had shorter settling time when K_{out} was increased. System had much oscillation again. The θ graphs are given in Fig. 7.

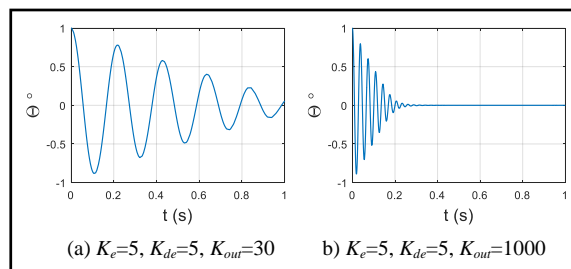

Figure 7. The effect of K_{out} on θ

The system had less oscillation when K_e was decreased and more oscillation when K_e was increased. The effect of K_e gain can be seen in Fig. 8. Small changes of the K_{de} do not have a significant effect on the system performance as seen as Fig. 9.

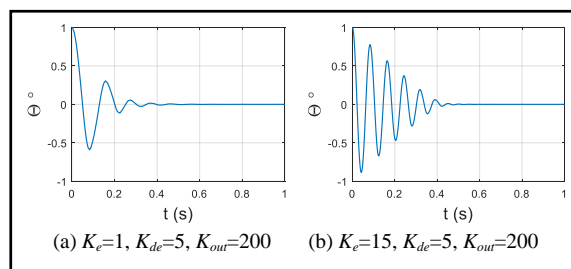

Figure 8. The effect of K_e on θ

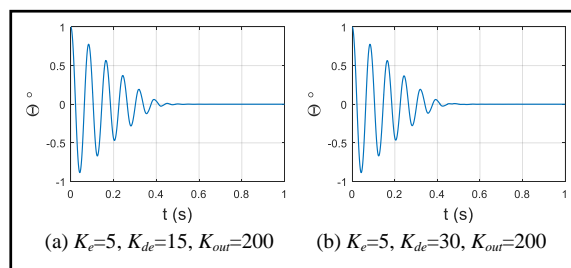

Figure 9. The effect of K_{de} on θ

A good performance couldn't be obtained by the tunings given above, but it is possible by changing some parameters of fuzzy logic controller. As seen in Table 3, "And method" and "implication method" were selected as "product" (prod); "aggregation method" was selected as "probabilistic or" (probor); and "Or method" was selected as "max". These parameters were used with both of triangular and Gaussian (gauss2mf) MF given in Fig. 10. The system performance was better with both of triangular and Gaussian MF when used with the new parameters. The θ output graphs of triangular and Gaussian MF are given in Fig. 11 for $K_e=K_d=5$ and $K_{out}=200$. Both of them generated shorter settling time and less oscillation.

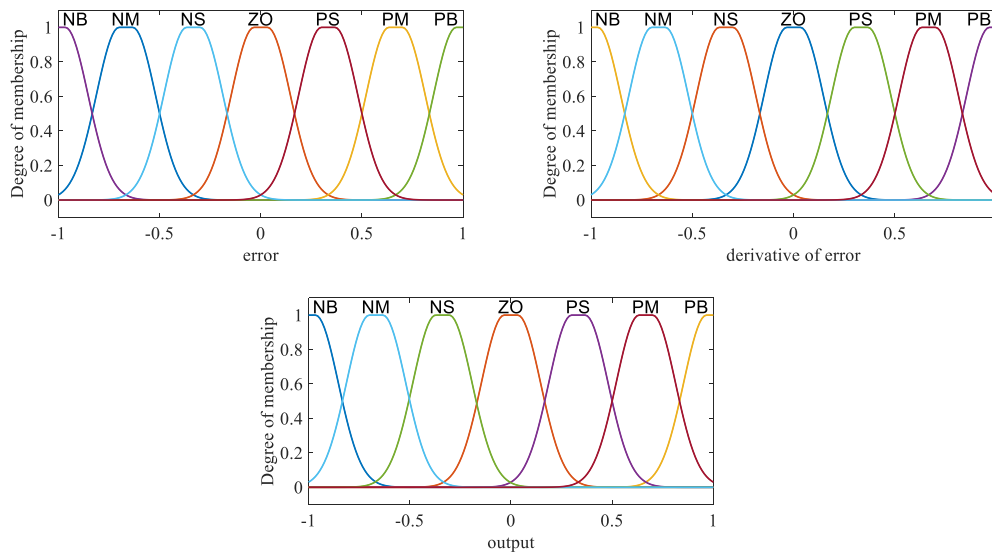

Figure 10. Gaussian membership functions of error and derivative of error inputs and the output

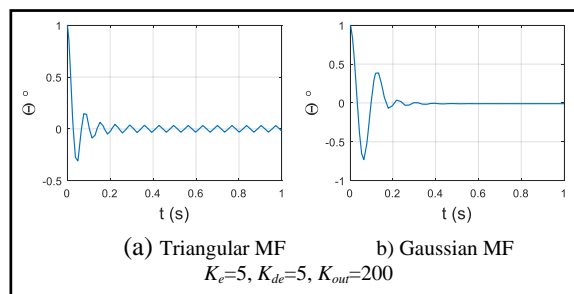

Figure 11. The effect of new parameters on θ

The effect of K_{out} for θ output can be seen in Fig. 12. System has longer settling time and less oscillation for small K_{out} . In a similar manner, it has shorter settling time and more oscillation for bigger K_{out} .

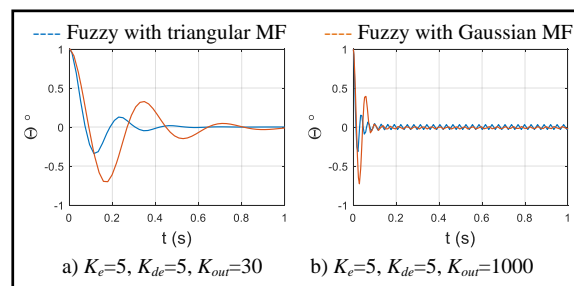

Figure 12. The effect of K_{out} on θ when prod, probor and max functions are used

The system output had no oscillation but longer settling time when K_e was decreased, and the system output had more oscillation and shorter settling time when K_e as increased. It can be seen in Fig. 13 that K_{de} has also a positive effect on the system performance. System output has shorter settling time with bigger K_{de} gain as seen as in Fig. 14.

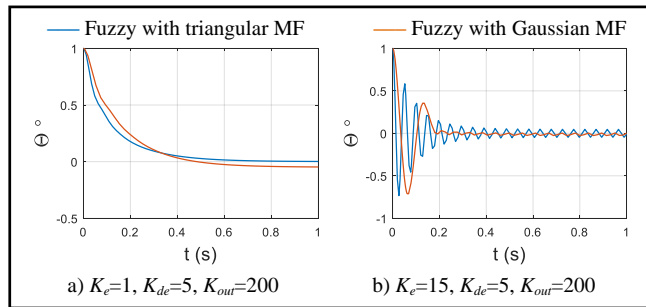

Figure 13. The effect of K_e on θ output when prod, probor and max functions are used

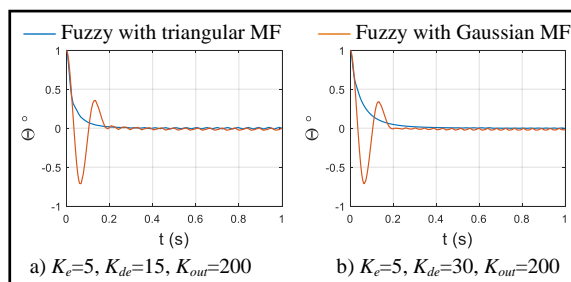

Figure 14. The effect of K_{de} on θ output when prod, probor and max functions are used

When used the triangular MF; the settling time was 0.150s with %2 tolerance, and there was no overshoot and steady-state error. When used the Gaussian MF; the settling time was 0.325s with %2 tolerance, max overshoot was 0.352°, and steady-state error is 0.019°. The system output graphs are given in Fig. 15.

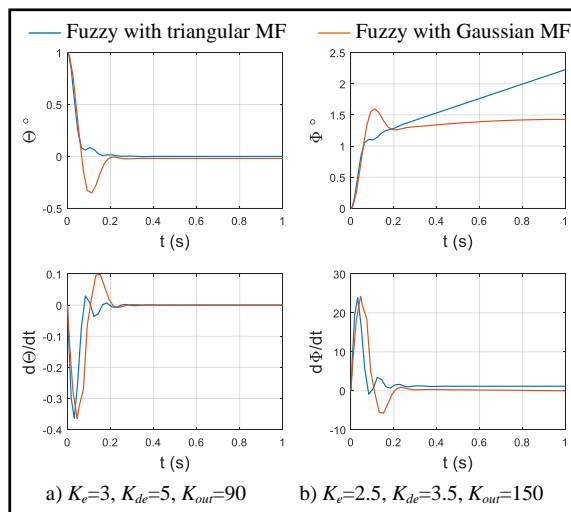

Figure 15. System outputs when used the optimized fuzzy logic controllers

Settling time, maximum overshoot and steady state errors are given in Table 4 for PID and fuzzy controlled systems. Fuzzy logic controller which has triangle MF has the best results. It's settling time is 0.15s and there are no maximum overshoot and steady-state error. The settling time of fuzzy logic controller which uses Gaussian MF is more than two times of fuzzy logic controller which has triangle MF. It has also maximum overshoot and steady-state error.

Table 4. Performance comparison

Performance Criteria	PID	Fuzzy Triangle MF	Fuzzy Gauss MF
Settling Time (s)	0.227	0.150	0.325
Maximum Overshoot (°)	0.146	0	0.352
Steady-State error (°)	0	0	0.019

The PID controller has an acceptable second best performance. Its settling time is more than fuzzy logic controller which uses triangle MF, but it is less than fuzzy logic controller which uses Gaussian MF. PID controller has also overshoot, but it is half of the maximum overshoot value of the fuzzy logic controller which uses Gaussian MF. It has also no steady-state error.

As a result, the controller which has the best performance is the fuzzy logic controller which uses triangle MF. The second best is the PID controller and the third one is the fuzzy logic controller which has Gaussian MF. It can be concluded that the fuzzy logic controller better than PID, when its parameters are selected correctly and the gains are tuned carefully.

4.2. Disturbance Inputs to The Best Performance Model

Robustness is tested by applying two different disturbance inputs to the triangular membership function model, which is the best performance model. An input with a duration of 1 second and an amplitude of 0.1 is applied at the 0.5 second moment of the simulation as the disturbance pulse function. Fig. 16 shows the method of applying the disturbance pulse input by forming it with unit step functions.

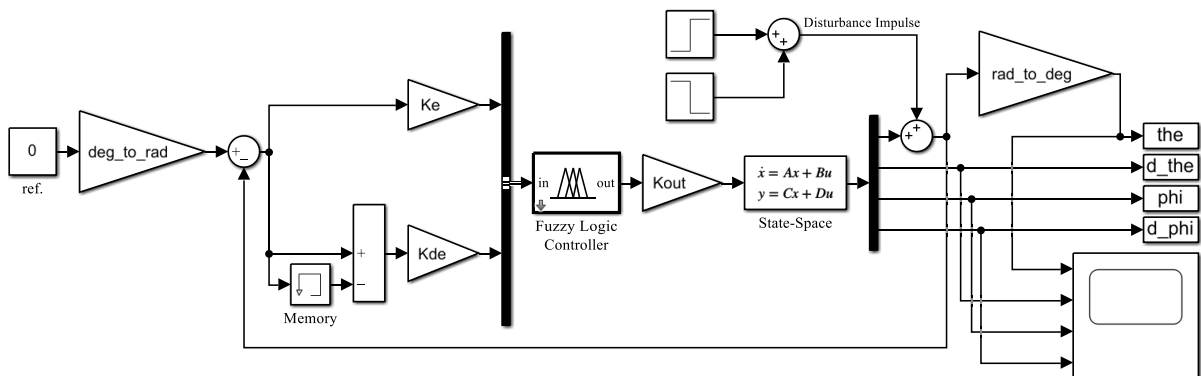

Figure 16. Simulink model with disturbance impulse input

Although the flywheel inverted pendulum model with disturbance input could not maintain the balance during the pulse, it immediately recovered when the pulse was retracted and settled in a stable control position. The response graph is shown in Fig. 17.

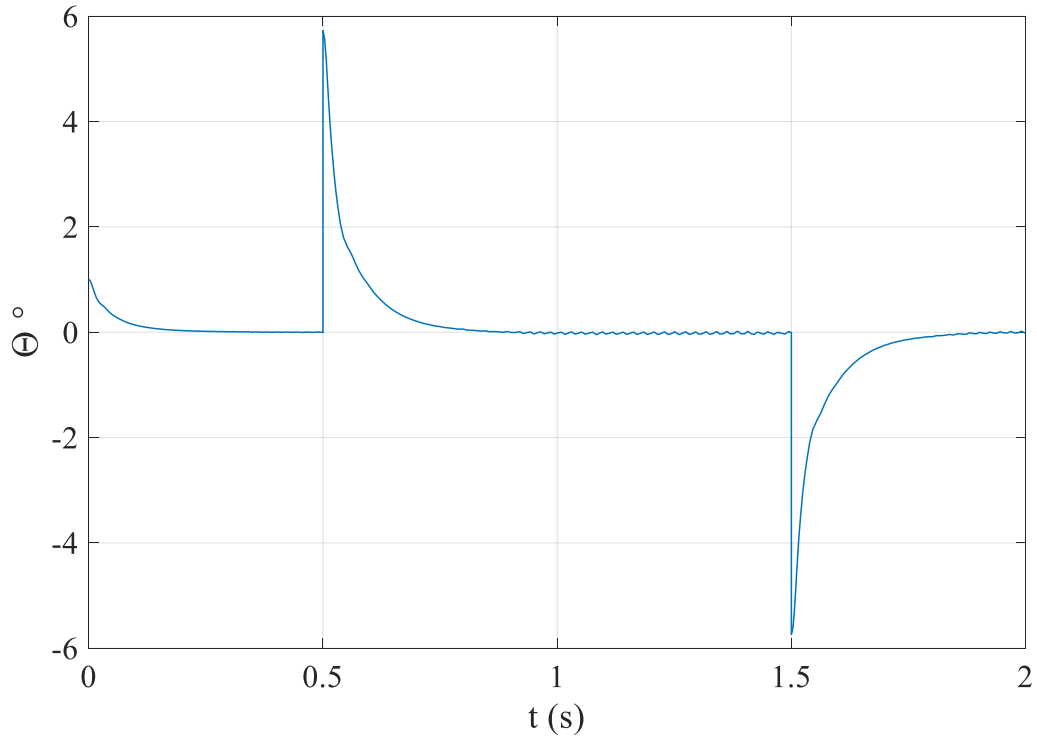

Figure 17. Response graph of the model with disturbance impulse input

Random noise disturbance input is applied secondary to the triangular membership function model. The random noise function is given by multiplying the ramp function with increasing amplitude, and thus the robustness of the control system is tested up to how many degrees of noise. Fig. 18 shows the method of applying the disturbance random input.

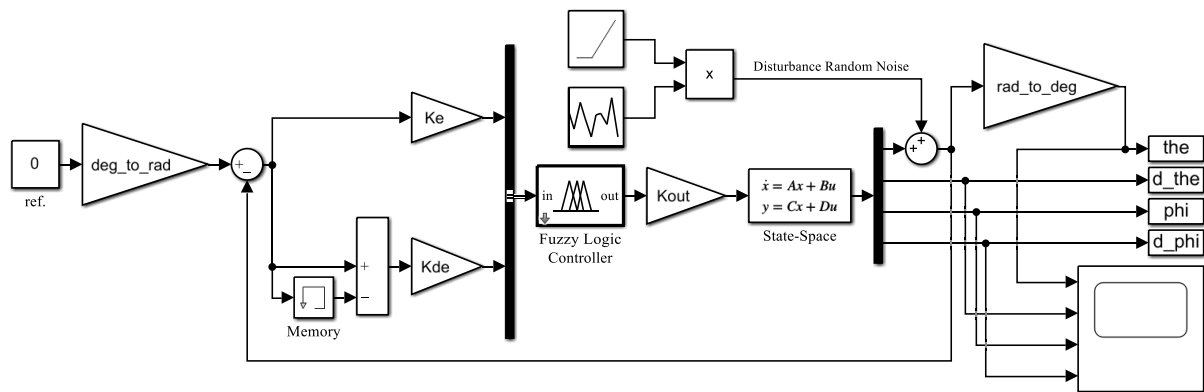

Figure 18. Simulink model with disturbance random noise input

As a result of this input, it is seen in Fig. 19 that the control system can provide the balance up to a certain amplitude of the noise. When the noise reaches about $\pm 8^\circ$ amplitudes, the control system loses its robustness.

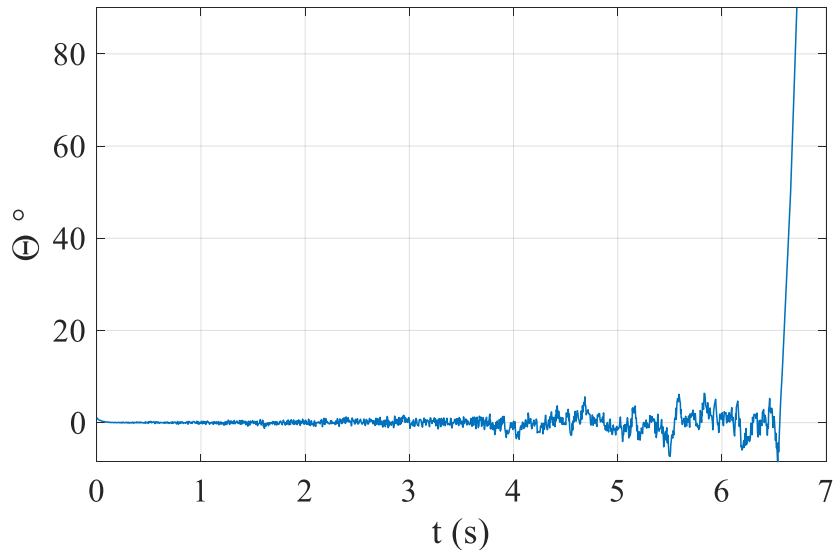

Figure 19. Response graph of the model with disturbance random noise input

In experimental studies, two different disturbance input methods were applied to test the robustness of the fuzzy logic controller in terms of amplitude and duration. In the literature, this test is usually provided with a single disturbance input (Olivares and Albertos, 2013; Ruan and Wang, 2010; Vasconcelos et al., 2019).

5. CONCLUSION

In this study, a fuzzy logic controller was designed and optimized by trial-and-error method for a flywheel inverted pendulum. Balance control is the main challenge in controlling an inverted flywheel pendulum. All fuzzy gains were tuned for the best performance. Also, some different functions were used for fuzzy methods like implication and aggregation. Fuzzy logic controller which uses triangular MF with “prod” and “probor” functions for and-implication-aggregation methods has the best performance in controlling the inverted pendulum. Fuzzy Logic controller which uses Gaussian MF has more overshoot and longer settling time. The designed fuzzy logic controllers are compared with a PID controller tuned by trial-and-error method again. The PID controller has an acceptable performance. Its performance is not good as fuzzy logic controller which uses triangular MF. PID has maximum overshoot and 0.077s longer settling time. However, it has better performance than fuzzy logic controller which uses Gaussian MF. PID controller has 0.098s shorter settling time, and 2.41 times less overshoot. It has also no steady state error. In experimental studies, two different disturbance input methods were applied to test the robustness of the fuzzy logic controller in terms of amplitude and duration. The best performance triangular MF model is robust under disturbance inputs.

The fuzzy logic controller which uses triangular MF has better performance when compared with the PID controller. But all tuning processes are made by trial-and-error method. An optimization algorithm should be used to make a more accurate comparison. It can be a future work. After all, fuzzy logic controller is a good choice when controlling a flywheel inverted pendulum.

6. CONFLICT OF INTEREST

Authors approve that to the best of their knowledge, there is not any conflict of interest or common interest with an institution/organization or a person that may affect the review process of the paper.

7. AUTHOR CONTRIBUTION

Author 1: Conceptualization, Data Curation, Software, Visualization, Writing-original draft, Supervision, Methodology.

Author 2: Conceptualization, Methodology, Software, Validation, Visualization, Formal Analysis, Writing - Review and Editing.

8. REFERENCES

- Andrievsky B. R., Global stabilization of the unstable Reaction-Wheel Pendulum. *Automation and Remote Control*, 72(9), 1981–1993, 2011.
- Bai Y., Wang D., Fundamentals of Fuzzy Logic Control—Fuzzy Sets, Fuzzy Rules and Defuzzifications. In *Advanced Fuzzy Logic Technologies in Industrial Applications*, Springer, London, pp. 17–36, 2006.
- Bobrow F., Angelico B. A., da Silva P. S. P., The Cubli: Modeling and Nonlinear Control Utilizing Unit Complex Numbers (arXiv:2009.14625), 2020.
- Erkol H. O., Ters Sarkaç Sisteminin Yapay Arı Kolonisi Algoritması ile Optimizasyonu. *Journal of Polytechnic*, 20(4), 863–868, 2017.
- Gajamohan M., Merz M., Thommen I., D’Andrea R., The Cubli: A cube that can jump up and balance. *2012 IEEE/RSJ International Conference on Intelligent Robots and Systems*, 3722–3727, 2012.
- Han H. Y., Han T. Y., Jo H. S., Development of omnidirectional self-balancing robot. *2014 IEEE International Symposium on Robotics and Manufacturing Automation (ROMA)*, September, 57–62, 2014.
- Hatada K., Sato M., Hirata K., Masui Y., Synthesis of a Calibration-Free Visual Feedback Controller for an Inverted Pendulum Using a Fisheye Lens. *IEEE Transactions on Industrial Electronics*, 69(12), 13348–13358, 2022.
- Huang H., Li Z., Guo Z., Guo J., Suo L., Wang, H., Prescribed Performance Adaptive Balance Control for Reaction Wheel-Based Inverted Pendulum-Type Cubli Rovers in Asteroid. *Aerospace*, 9(11), Article 11, 2022.
- Jain N., Gupta R., Parmar G., Intelligent Controlling of an Inverted Pendulum Using PSO-PID Controller. *International Journal of Engineering Research and Technology (IJERT)*, 2(12), 3712–3716, 2013.
- Meyer J., Delson N., De Callafon R. A., Design, modeling and stabilization of a moment exchange based inverted pendulum. *IFAC Proceedings Volumes (IFAC-PapersOnline)*, 15(PART 1), 462–467, 2009.
- Mishra S. K., Chandra D., Stabilization and Tracking Control of Inverted Pendulum Using Fractional Order PID Controllers. *Journal of Engineering*, 1–9, 2014.
- Moghadam A. A. A., Marshall M., Robust Control of the Flywheel Inverted Pendulum System Considering Parameter Uncertainty. *2021 American Control Conference (ACC)*, 1730–1735, 2021.

- Mondal R., Dey J., A novel design methodology on cascaded fractional order (FO) PI-PD control and its real time implementation to Cart-Inverted Pendulum System. *ISA Transactions*, 130, 565–581, 2022.
- Nawawi S. W., Ahmad M. N., Osman J. H. S., Real-Time Control of a Two-Wheeled Inverted Pendulum Mobile Robot. *Engineering and Technology*, 2(3), 406–412, 2008.
- Niemann H., Poulsen J. K., Analysis and design of controllers for a double inverted pendulum. *Proceedings of the 2003 American Control Conference*, 4, 2803–2808, 2003.
- Olivares M., Albertos P., On the linear control of underactuated systems: The flywheel inverted pendulum. *2013 10th IEEE International Conference on Control and Automation (ICCA)*, November, 27–32, 2013.
- Özmen İ., Közkurt C. (2021). Design of Fuzzy Logic Supported Car Driver Control System. *International Journal of Automotive Science And Technology*, 5(3), Article 3, 2021
- Prutskii A. S., Mikhalkov N. V., Vasiliev E. Y., Synthesis technique for control of a CMG Stabilization of an inverted pendulum which does not require repeated code generation. *Journal of Physics: Conference Series*, 2373(9), 092005, 2022.
- Razmjoooy N., Madadi A., Alikhani H.-R., Mohseni M., Comparison of LQR and Pole Placement Design Controllers for Controlling the Inverted Pendulum. *Journal of World's Electrical Engineering and Technology (JWEET)*, 3(2), 83–88, 2014.
- Ruan X. G., Wang Y. F., The modelling and control of flywheel inverted pendulum system. *Proceedings - 2010 3rd IEEE International Conference on Computer Science and Information Technology, ICCSIT 2010*, 6, 423–427., 2010
- Tavana M., Hajipour V., A practical review and taxonomy of fuzzy expert systems: Methods and applications. *Benchmarking: An International Journal*, 27(1), 81–136, 2019.
- Vasconcelos J. R. C., González E. M. A., Foyo P. M. G. D., Design and Control of a Flywheel Inverted Pendulum System. *Congresso Brasileiro de Automática - CBA*, 1(1), Article 1, 2019.
- Villacrés J., Viscaino M., Herrera M., Camacho, O., Controllers Comparison to stabilize a Two-wheeled Inverted Pendulum: PID, LQR and Sliding Mode Control 2 Description of the Two Wheeled Inverted Pendulum. *Controllers Comparison to Stabilize a Two-Wheeled Inverted Pendulum: PID, LQR and Sliding Mode Control*, 1(January), 29–36, 2016.
- Wang C., Yin G., Liu C., Fu W., Design and simulation of inverted pendulum system based on the fractional PID controller. *2016 IEEE 11th Conference on Industrial Electronics and Applications (ICIEA)*, 5, 1760–1764, 2016.
- Wasiwitono U., Wahjudi A., Saputra A. K., Yohanes, Stabilization and disturbance attenuation control of the gyroscopic inverted pendulum. *Journal of Vibration and Control*, 27(3–4), 415–425, 2021.
- Wu J., Zhang W., Wang S., A Two-Wheeled Self-Balancing Robot with the Fuzzy PD Control Method. *Mathematical Problems in Engineering*, 2012, 1–13, 2012.