

Static Capacity Curves of Reinforced Concrete Structures Exposed to High Temperature Effects

Elif Nazlı KÜÇÜK^{1*}, Oğuz Akın DÜZGÜN¹

¹Atatürk University, Engineering Faculty, Department of Civil Engineering, 25240, Erzurum, Turkey

Geliş / Received: 24/11/2022, Kabul / Accepted: 14/12/2022

Abstract

In this study, it is aimed to investigate the seismic performance of a reinforced concrete (RC) structural system exposed to high temperatures. For this purpose, an RC structure with 4 stories and 4 spacings was designed. First of all, column and beam elements were modeled by using ANSYS software, and then, thermal analysis was performed assuming that they were exposed to the standard fire curve to obtain the temperature distributions in the cross-sections of the reinforced concrete elements. Secondly, the sectional analyses were performed for the reinforced concrete element sections and moment-curvature relations were obtained. Finally, the three-dimensional (3D) structural system was modeled and static pushover analysis was carried out in accordance with the Turkish Building Earthquake Code (TBEC 2018). The results showed that as the exposure time to high-temperature increases the inelastic displacement capacity and the base shear force values decrease. The results were also affected by the location of the fire event. Besides, plastic hinges occurred more quickly than the situation before the fire event, resulting in a decrease in the load-carrying capacity and stiffness of the system.

Keywords: RC elements, High temperatures, Pushover analysis, Sectional response, Finite elements.

Yüksek Sıcaklık Etkilerine Maruz Kalmış Betonarme Yapıların Statik Kapasite Eğrileri

Özet

Bu çalışmada, yüksek sıcaklığa maruz kalmış betonarme bir yapı sisteminin sismik performansı araştırılmıştır. Bu amaç doğrultusunda 4 katlı ve 4 açıklıklı betonarme bir yapı tasarlanmıştır. Öncelikle kolon ve kiriş elemanlar ANSYS yazılımı kullanılarak modellenmiş ve daha sonra betonarme elemanların kesitlerindeki sıcaklık dağılımlarını elde etmek için standart yangın eğrisine maruz kaldıkları varsayılarak termal analiz yapılmıştır. İkinci olarak betonarme eleman kesitleri için kesit analizleri yapılmış ve moment-eğrilik ilişkileri elde edilmiştir. Son olarak, üç boyutlu (3B) yapısal sistem modellenmiş ve Türkiye Bina Deprem Yönetmeliği'ne (TBDY 2018) uygun olarak statik itme analizi yapılmıştır. Sonuçlar, yüksek sıcaklığa maruz kalma süresi arttıkça inelastik yer değiştirme kapasitesinin arttığını ve taban kesme kuvveti değerlerinin azaldığını göstermiştir. Sonuçlar ayrıca yangın olayının konumundan da etkilenmiştir. Ayrıca plastik mafsallar yangın öncesi duruma göre daha hızlı meydana gelerek sistemin yük taşıma kapasitesinde ve rijitliğinde azalmaya neden olmuştur.

Anahtar Kelimeler: Betonarme elemanlar, Yüksek sıcaklık, İtme analizi, Kesit analizi, Sonlu elemanlar.

*Corresponding Author: elifnazli@atauni.edu.tr
Elif Nazlı Küçük: <https://orcid.org/0000-0002-9369-1415>
Oğuz Akın Düzgün: <https://orcid.org/0000-0003-0842-9031>

1 Introduction

It is known that Turkey is located in the Mediterranean, Alpine, and Himalayan seismic zones, which is one of the most active seismic zones on the earth. Major earthquakes can result in a series of catastrophic events, such as a post-earthquake fire. Recorded experience has shown that the effects of post-earthquake fires on urban areas can be even worse than the earthquake itself [1]. From this, it can be deduced that no urban building is designed for two simultaneous or sequential overloads, such as earthquakes and fire. Therefore, urban structures are very weak when exposed to fire after being damaged by a previous earthquake [2]. These data and events clearly show how important earthquake and fire safety is so the design of buildings under the influence of fire and earthquake should be done in accordance with the relevant regulations and standards.

Fires cause life, structure, and economic losses all over the world. The increasing temperature on an RC member surface leads to the propagation of temperature to the inner layers of concrete, and so the strength of both concrete and the reinforcing steel reduces [3]. Therefore, in order to evaluate the fire resistance of the reinforced concrete element, it is necessary to know the sectional temperatures in concrete and steel. It is known that the temperature variations in cross-sections depend on many factors, such as the thermal properties of concrete and reinforcing steel, the types of time-temperature curves, and the section dimensions. Therefore, it is important to investigate the thermal properties and structural behavior of fire-damaged RC structures to understand their load-bearing capacity and safety [4].

Bhuiyan and Ahmed [3], Xiao and Konig [5], Eunmi et al [6], and Short et al [7] studied the behavior of concrete under the effect of fire and as a result, after exposure to fire, decrease in the strength and modulus of elasticity of the concrete, cracks and spalling in the concrete, decrease in the load – carrying capacity and stiffness of the structure, color changes of concrete, decrease in the density of the concrete and significant changes in the appearance of the surface stated that they were observed. Ivanka et al [8] stated that the thermal properties of concrete are mainly related to the type of aggregate used. Shah and Sharma [9] have studied the reinforcing effect of high temperature in concrete. Nassif [10] and Youssef [11] studied stress-strain relationships for structures exposed to fire. They compared existing stress-strain models for reinforced concrete structures at normal and high temperatures. The thermal properties and structural behavior of reinforced concrete beams exposed to fire were investigated both experimentally and analytically by Luccioni et al [12], Pearce et al [13] and Ryu et al [14], according to their load levels and section dimensions. Wu and Li [15] developed a three-dimensional nonlinear finite member model to understand the thermal and mechanical behavior of a reinforced concrete T-shaped beam under three different temperature-time curves. Kurt and Tonyalı [16] carried out the performance-based design of a 4-story with 3-span reinforced concrete frame system in accordance with the Turkish Building Earthquake Code (TBEC 2018). Chaudhari and Dhoot [17] designed a four-story reinforced concrete building and analyzed it for life safety performance level in SAP2000 [18] software. From the analysis, it was checked whether the performance level of the building is according to the assumptions. Meacham [19], examined a full-scale, five-story reinforced concrete building test specimen onto a large outdoor

high-performance shaking table. The specimen was subjected to a series of earthquake motions. After the shaking tests, some areas on the 3rd floor were exposed to fires of varying sizes. By post-experiment analysis, it was observed how such damage would affect the life safety of building occupants during fires in earthquake-damaged buildings.

Although many studies have been carried out on the effect of fire or high temperature exposure after the earthquake in the literature research, there has not been enough study on structures that have been exposed to earthquakes without post-fire reinforcement. Hacıemiroğlu [20] investigated the nonlinear behavior of reinforced concrete structures exposed to fire under the influence of earthquakes by performing linear inelastic pushover analysis according to TEC 2007 [21].

The aim of this paper is to determine the seismic performance of RC structures after exposing to fire or high temperatures according to Turkish Building Earthquake Code (TBEC) (2018) [22]. Structural elements were modeled by using ANSYS [23] software to obtain the temperature distributions in cross-sections of the RC elements, thermal analysis was conducted considering the standard fire curve. Then, the sectional analyses were performed for the RC element sections and moment-curvature relations were obtained. Finally, the three dimensional (3D) structural system was modeled and nonlinear static pushover analysis was carried out in accordance with the TBEC (2018) [22]. Performance-based seismic design (PBSD) evaluates how buildings will perform under a design earthquake. PBSD provides a methodology for evaluating a building's seismic performance, ensuring life safety and minimal economic losses [17]. This methodology is an elastic design methodology done on the probable performance of the building under input ground motions [24]. The plastic hinge properties can be obtained either experimental [25] or theoretical. In this study, the plastic hinge properties were obtained from the results of the sectional analyses.

2 Material and Methods

According to TBEC 2018 [22], Turkish Standards (TS) TS 498 [26], TS 500 [27], and TS 708 [28] standards, an RC structural system with 4 story and 4 spacings (residence) considered. The spacing of the frame is taken as 5 m in the x-direction, 4 m in the y-direction and the floor height as 3 m. The floor plan of the considered structure shown in Figure 1. The compressive strength and the modulus of elasticity of concrete were 30 MPa and 33000 MPa respectively. The selected reinforcing steel type was B420C and the yield strength and the modulus of elasticity of reinforcing steel were 420 MPa and 210000 MPa, respectively.

It was assumed that the structural system considered in this study is located in Erzurum-Palandöken district. The related parameters taken from the Disaster and Emergency Management Presidency (AFAD) [29] website. The dimensions of the columns and beams were 40x40 cm and 40x50 cm, respectively. The slab thickness was 12 cm, and the concrete cover thickness was taken 3 cm. The reinforcement layout of the columns and beams is shown in Figure 2.

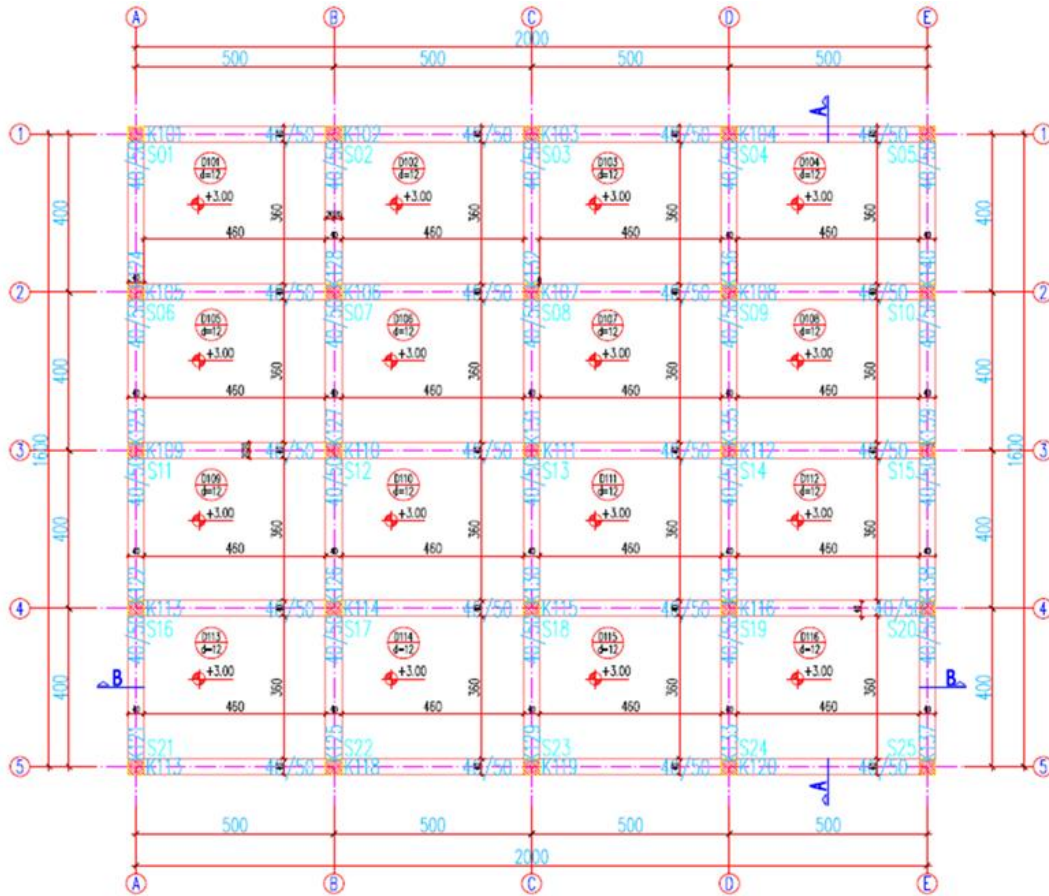

Figure 1. The floor plan

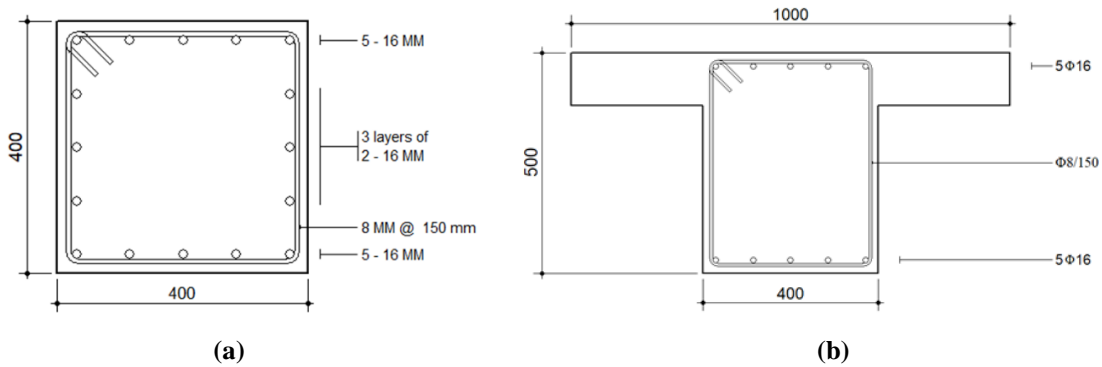

Figure 2. Details of the column (a) and beam (b).

In order to determine the changes in the behavior of the structural elements exposed to fire, thermal analysis was carried out using ANSYS [23] software and the temperature distributions in the sections of the elements were obtained. It was deemed appropriate to use the ISO 834 [30] standard fire curve in order to give the fire effect [14, 15, 31]. The ISO 834 standard fire curve was calculated with the Equation (1) [32] and shown in Figure 3.

$$\theta_g = 20 + 345 \log_{10} (8t + 1) \text{ (}^\circ\text{C)} \quad (1)$$

where, θ_g is temperature at time t in degree Celsius, t is fire exposure time in minutes.

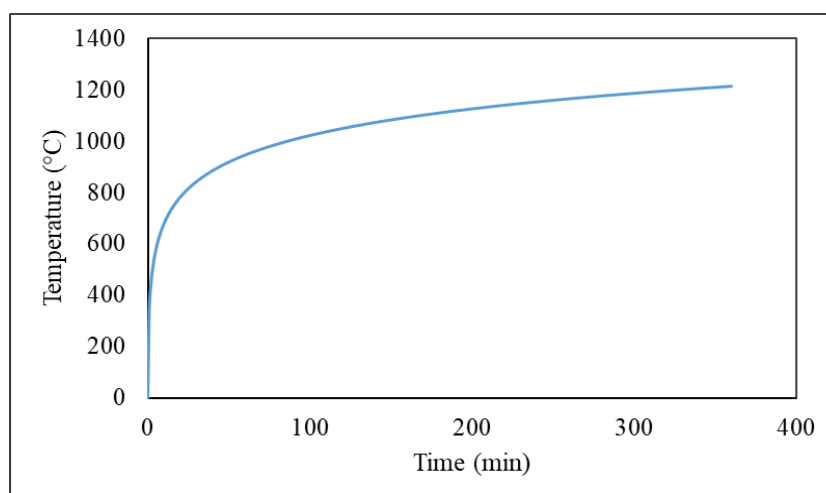

Figure 3. ISO 834 standard fire curve

When objects with different temperatures come into contact with each other, heat flows from the hot to the cold. The heat flow always occurs in the direction of the temperature drop. Heat flow can occur via three mechanisms: by conduction (contact), by convection (via motion), and by radiation (by radiation). The origin of all heat transfer laws comes from the 1st law of thermodynamics, in other words, the Conservation of Energy principle. Fourier Heat Transfer law is used to express the energy balance in a solid body. The Fourier Heat Transfer Law is illustrated by Equation (2).

$$q = -kA \frac{\partial T}{\partial x} \quad (2)$$

where k is the heat transfer coefficient, A is the surface area perpendicular to the heat transfer, ∂T the temperature difference, and ∂x the thickness.

After obtaining the temperature distributions in the sections, the changes in the mechanical and physical properties of the materials used in the bearing elements depending on the temperature in the section were determined by considering Eurocode 1 [33], Eurocode 2 [32], Eurocode 4 [34]. Then, the mechanical and physical properties that change according to the temperature value reached by each 2 cm concrete layer from the surface to the inside in the element sections were defined to the relevant layer and sectional analyses were carried out. Mander [35] unconfined and confined concrete models used for concrete. As a result of sectional analysis, the moment-curvature relations were obtained. The moment-curvature curves were used for defining the plastic hinge properties.

Finally, according to the rules specified in the TBEC (2018) [22] the capacity curves of the system was determined by performing pushover analyses by using SAP2000 [18] software for different fire scenarios. The pushover analysis, is the process of pushing the structure incrementally in the horizontal direction with a prescribed load pattern until the ultimate state of the structure. These curves represent the structural behavior under increasing lateral forces. In this study, the displacement-controlled nonlinear analysis was performed. In the pushover analysis, the mass source was defined as the combination of 100% dead load and 30% live load.

The effective stiffness of the RC members was defined as per the guidelines of TBEC (2018) [22]. The bending related plastic hinges were defined for the beams and the bending with axial load related plastic hinges were defined for the columns. In the analyses, the rigid diaphragm model was accepted for the slabs. For the structural system considered in this study, the slab load was assumed as 5.12 kN/m^2 , the wall load on the outer beams was 8.6 kN/m , and the wall load on the inner beams was 5.4 kN/m as dead load. The live load on the normal floor floors was taken as 2 kN/m^2 , and on the roof floor was taken as 1.5 kN/m^2 . The obtained results were evaluated by comparing the behavior of the structural system that was not exposed to high temperatures.

3 Results and Discussion

3.1 Temperature effects on stress-strain relations

The variation of stress-strain relations with temperature of C30 concrete and B420C reinforcing steel used in this study are shown in Figures 4-5, respectively. These stress-strain relations were computed from Eurocode 2 [32].

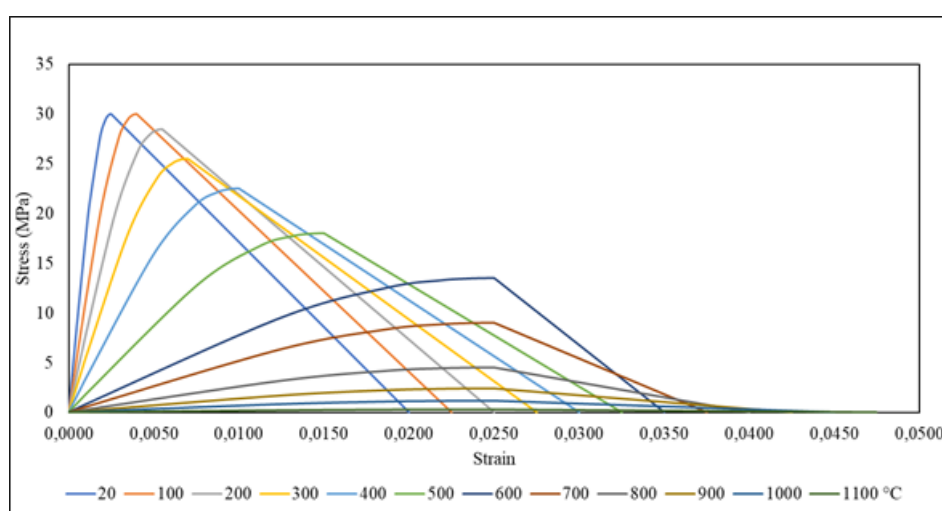

Figure 4. Stress-strain relations of C30 concrete for different temperatures

As it can be seen in Figure 4, as the temperature increases, the bearing capacity and modulus of elasticity of the concrete decrease, and the deformation capacity increases. As the temperature of the concrete reaches up to 400°C , Concrete loses approximately 25% of its compressive strength while its deformation capacity increases by about 50%; When the temperature reaches 600°C , Concrete lost its strength by 55% and increased its deformation capacity by 75%; When the temperature reaches 900°C , it can be seen that concrete loses almost 90% of its strength and its deformation capacity increases by 112%. The strength loss is probably due to the water in the concrete evaporating with the effect of temperature, causing spalling on the surface. As the strength and moisture content of the concrete increase, this spalling on the surface increases. The reason for the increase in the deformation capacity is that the thermal expansion coefficient increases depending on the temperature.

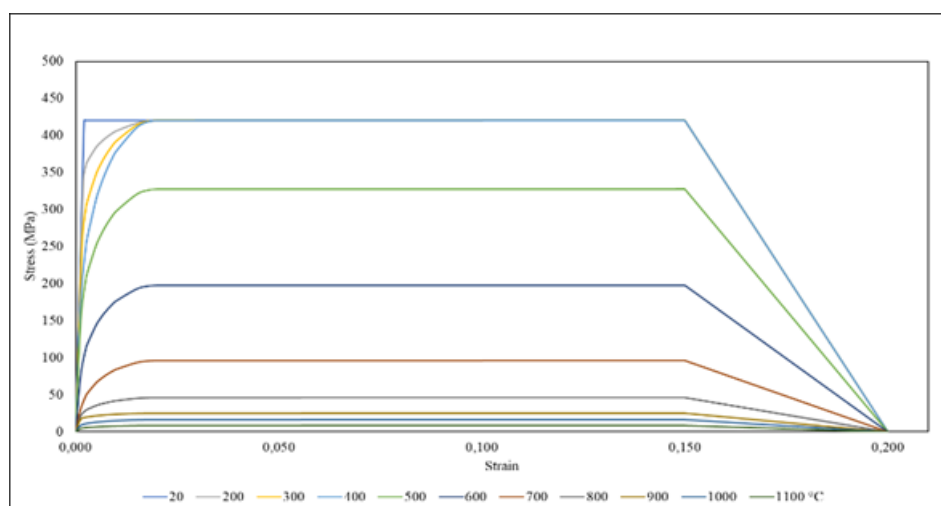

Figure 5. Stress-strain relations of B420C reinforcing steel for different temperatures

When Figure 5 is examined, it can be seen that the bearing capacity of the reinforcing steel decreases proportionally to the temperature. It can be said that the reinforcing steel can keep its strength up to 400°C without deterioration, but after this degree, it loses its strength rapidly. It is seen that it loses almost half of its tensile bearing capacity at 600°C, while it loses 90% when the temperature reaches 800°C.

3.2 Thermal analysis

The temperature distribution of the columns, and beams for exposing to high temperature for 30-60-90 minutes, whose results were to be used in the section and earthquake analysis, are shown in Figures 6-7. The results shown in Figures 6-7 are compatible with the literature [3, 5, 6, 10, 11]. According to the published result, increase in the exposure time to high temperatures, the temperature of the inner layers will consequently increase.

When Figure 6 is examined, it can be seen that when the column is exposed to fire for 30 minutes, the temperature of the outermost layer of the column rises up to 831°C, while the temperature in the innermost layers remains 20°C. When the fire exposure time of the column reaches 90 minutes, it is seen that the outer layer of the column rises to 1002°C and the inner layer to 73°C, protecting the inner layers of the concrete against high temperatures.

When the Figure 7 are examined, it is seen that when the beam is exposed to fire for 30 minutes, the temperature of the outermost layer of the beam rises up to 825°C, while the temperature in the innermost layers remains 20°C. When the exposure time of the beam reaches 90 minutes, it is seen that the outer layer of the beam rises to 1000°C and the inner layer to 45°C. It can be said that the results correspond with the literature [20].

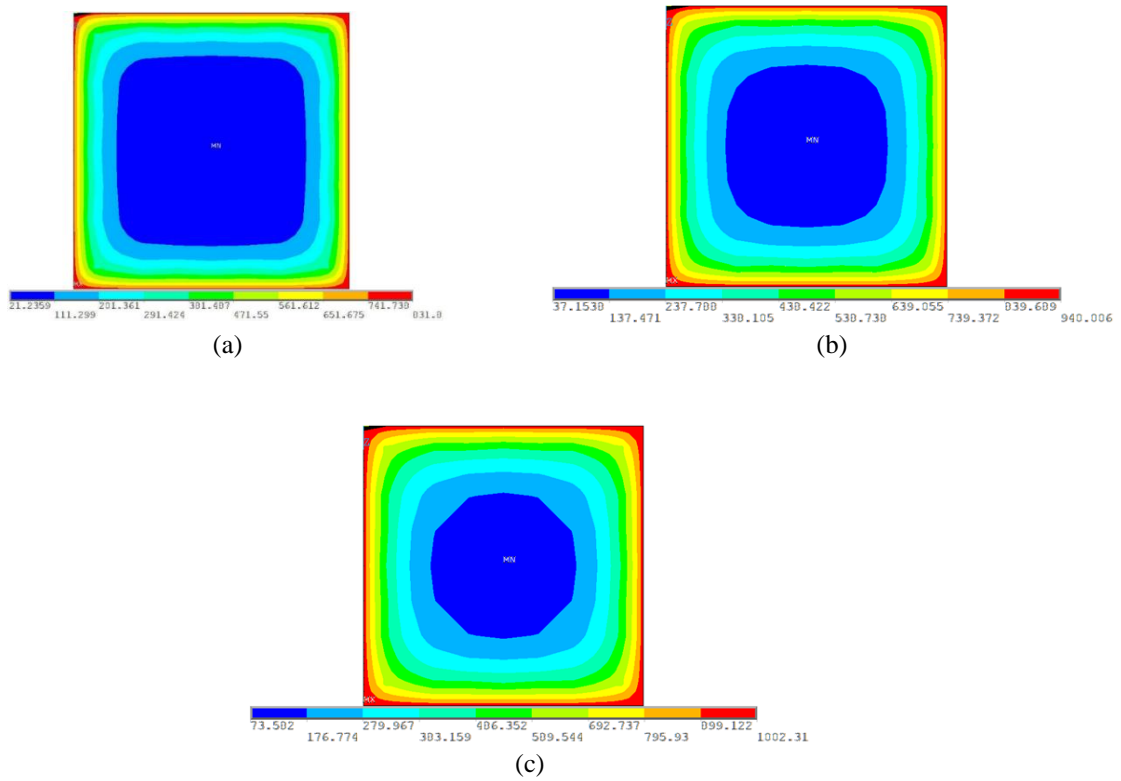

Figure 6. Temperature distribution of column section exposed to fire (a) for 30 minutes, (b) for 60 minutes, and (c) for 90 minutes ($^{\circ}\text{C}$)

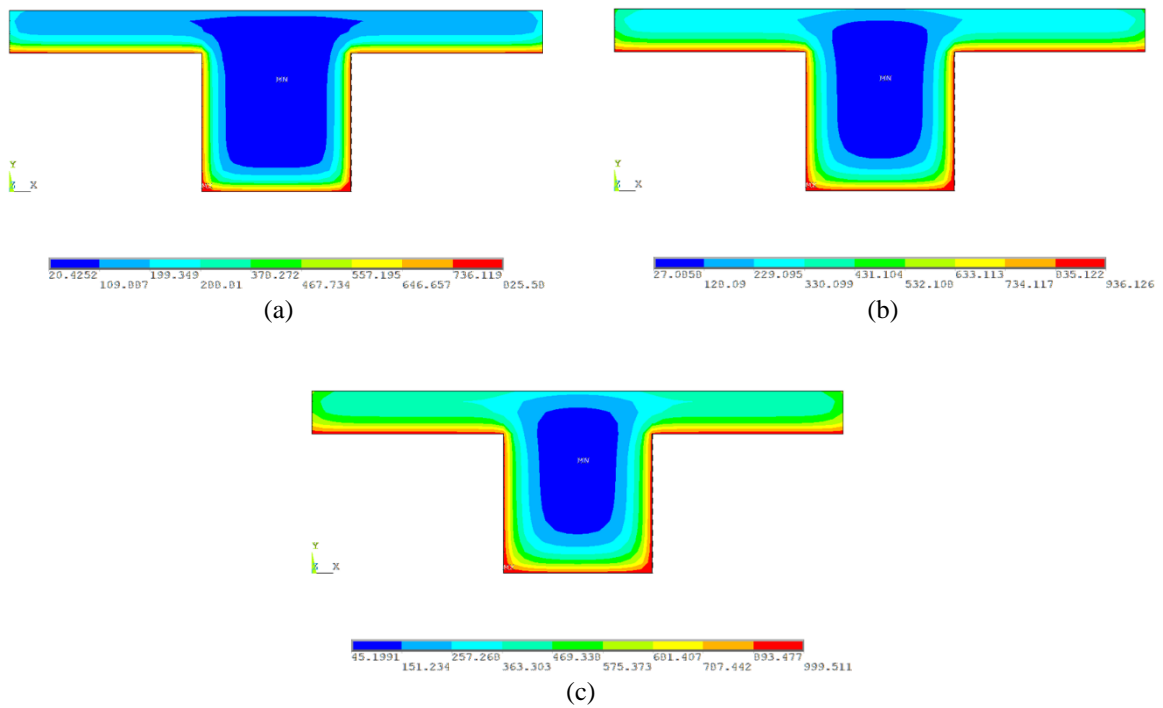

Figure 7. Temperature distribution of beam section exposed to fire (a) for 30 minutes, (b) for 60 minutes, and (c) for 90 minutes ($^{\circ}\text{C}$)

3.3 Sectional analysis

The variation of the moment-curvature relations obtained as a result of the sectional analysis of beams and columns with temperature and the variation of the axial load-moment relationship of the columns with temperature are given in Figures 8-9.

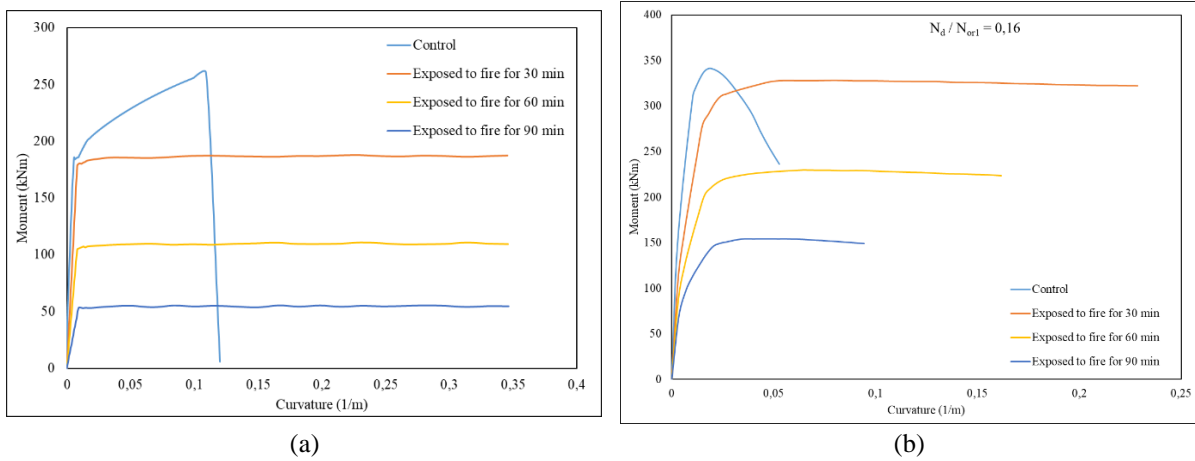

Figure 8. Variation of moment-curvature relationship (a) of beam section, and (b) of the column section with temperature

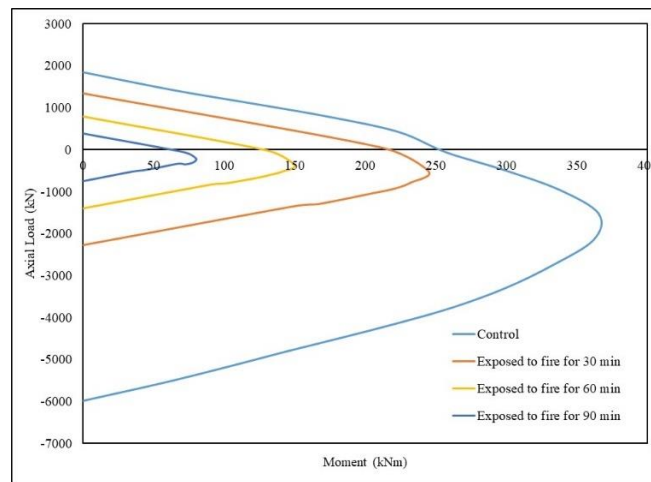

Figure 9. Variation of Moment – Axial load relation of column sections with temperature

It can be seen that the beam loses about 30%, 60%, and 80% of its moment-carrying capacity after 30, 60, and 90 minutes of exposure to fire, respectively. With similar to beams, it can be said that the moment carrying capacity of the columns is related to the fire exposure time, and the moment carrying capacity decreases as the exposure time increases. In addition, as the axial load level increases, it can be seen that the moment carrying capacity increases up to a point and starts to decrease after reaching the maximum moment carrying capacity. It can be seen that the column, loses about 5%, 30%, and 55% of its moment carrying capacity after 30, 60, and 90 minutes of exposure to fire, respectively. From this, it can be concluded that beams are more damaged by heat than columns. This can be explained by the fact that the confinement effect is greater in the columns [9].

3.4 Pushover analysis

The static capacity curves (base shear force – peak displacement) obtained as a result of the pushover analysis are presented separately in Figures 10-12 for 30, 60, and 90 minutes, respectively.

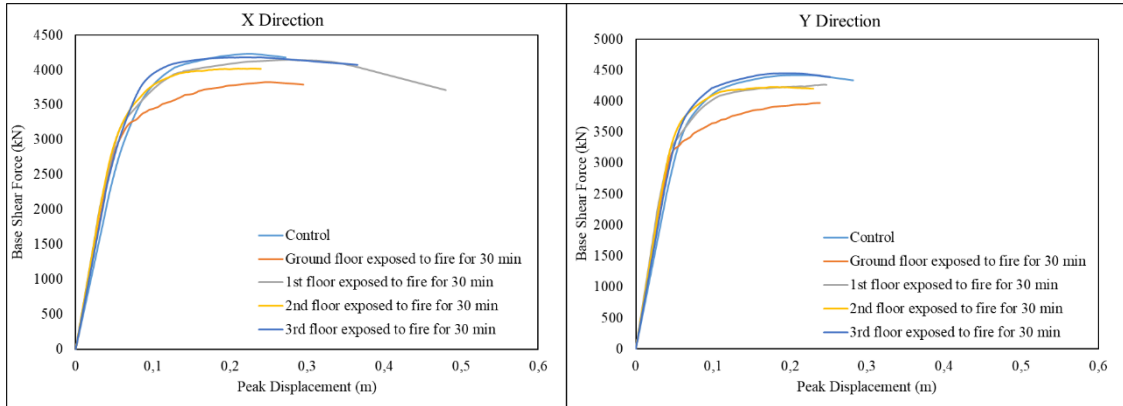

Figure 10. Static pushover capacity curves in X and Y directions when the structure is exposed to fire for 30 min

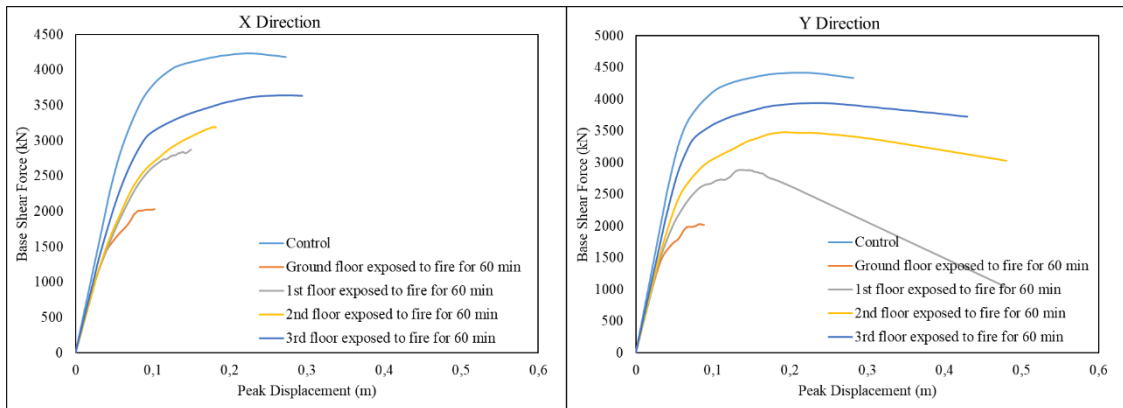

Figure 11. Static pushover capacity curves in X and Y directions when the structure is exposed to fire for 60 min

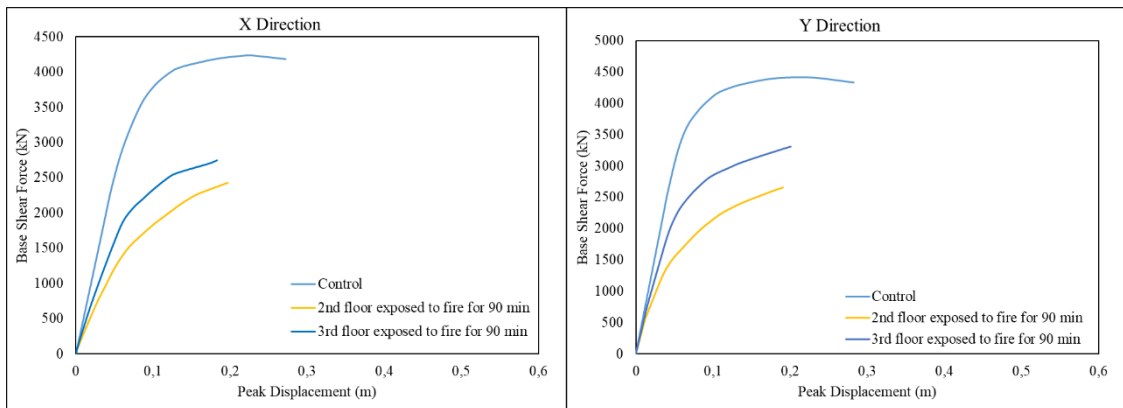

Figure 12. Static pushover capacity curves in X and Y directions when the structure is exposed to fire for 90 min

In situations where the ground floor is exposed to fire are examined, it can be seen that there is a decrease in the base shear force and the peak displacement of the building system. There is a 10% decrease in the base shear force at the end of 30 minutes and 50% at the end of 60 minutes. In addition, an increase of approximately 5% was observed in the amount of peak displacement at the end of 30 minutes, and a decrease of 65% at the end of 60 minutes was observed. In the case where the first floor is exposed to fire are examined, it is observed that the base shear force remains approximately the same after 30 minutes, but there is a decrease of 30% at the end of 60 minutes. The amount of peak displacement was increased by approximately 45% after 30 minutes, followed by a 35% decrease after 60 minutes. In the situation where the second floor is exposed to fire, it is seen that the base shear force decreases by approximately 5% at the end of 30 minutes, 25% at the end of 60 minutes, and 40% at the end of 90 minutes. The amount of peak displacement decreased by 10% after 30 minutes and remained constant. When the third floor is exposed to fire, it is seen that the base shear force does not change after 30 minutes, but there is a 15% at the end of 60 minutes. The amount of peak displacement was increased by approximately 25% after 30 minutes, followed by a decrease of approximately 30% after 90 minutes. No one-to-one study was found to compare the capacity curve results. However, it can be said that the general trend of capacity curves is occurred in the expected direction.

4 Conclusions

The seismic performance of an RC structure after exposure to a fire event was determined according to Turkish earthquake code regulations. Thermal analysis, sectional analysis, and pushover analysis were carried out to determine the seismic performance of the structure, respectively. The seismic performance of the RC structure was evaluated in terms of base shear force-top floor displacement relations. It was found that the high temperatures and exposure duration to high temperatures significantly affect the mechanical properties of the structural members, and so this leads to the structural system exhibiting worse seismic performance than the structural system in which no fire condition. Based on the overall trends of the results obtained from the present study following conclusions can be drawn:

- When the structural elements are subjected to high temperatures, the amount of temperature gradually decreases as expected from the exterior surface to the inner layers. In this case, it can be said that increasing in the section dimensions and cover thickness will help us to reduce the damage level of the element.
- As exposure duration to high temperatures of the structural elements increase, the mechanical properties of the materials parallelly decrease. Besides, the bending moment and axial load-carrying capacities of the structural members also decrease.
- As the exposure time to the high temperatures increases, the base shear force decreases, and the occurrence of fire events on the floors close to the ground level causes the decrease in the base shear force to be more pronounced.
- As the exposure time to high-temperature increases, the inelastic displacement capacity and the base shear force values decrease.
- Plastic hinges occurred more quickly than the situation before fire event, resulting in a decrease in the load-carrying capacity and stiffness of the system.

Ethics in Publishing

There are no ethical issues regarding the publication of this study.

Author Contributions

E.N. Küçük: methodology, investigation, writing, original draft; **O.A. Düzgün:** conceptualization, methodology, investigation, review and editing, supervision.

Acknowledgments

This study was presented as an oral presentation at the "International Conference on Advanced Engineering Technologies (ICADET' 22)" symposium held in Bayburt on September 28-30, 2022.

References

- [1] Mohammadi, J., Alyasin, S., (1992). Analysis of post-earthquake fire hazard, *Tenth World Conference on Earthquake Engineering*, Netherland.
- [2] Chen, S., Lee G. C. Shinozuka M., (2004). Hazard mitigation for earthquake and subsequent fire, *In ANCER Annual Meeting: Networking of Young Earthquake Engineering Researchers and Professionals*.
- [3] Bhuiyan, M. H., Ahmed S., (2021). Post-Fire Residual Capacity of Reinforced Concrete Beam, *Advances in Civil Engineering*, Ed: M.P. Sigma Research and Consulting Sdn. Bhd. Malaysia, 117-126.
- [4] Kodur, V., Baolin Y., Dwaikat M., (2013). A simplified approach for predicting temperature in reinforced concrete members exposed to standard fire, *Fire Safety Journal*, 56, 39-51.
- [5] Xiao, J., Konig G., (2004). Study on concrete at high temperature in China an overview, *Fire Safety Journal*, 39, 89-103.
- [6] Ryu, E., Shin, Y., & Kim, H., (2018). Effect of loading and beam sizes on the structural behaviors of reinforced concrete beams under and after fire. *International Journal of Concrete Structures and Materials*, 12(1), 1-10.
- [7] Short, N. R., Purkiss J. A., Guise S. E., (2001). Assessment of fire damaged concrete using colour image analysis, *Construction and Building Materials*, 15, 9-15.
- [8] Ivanka, N., Ivana K., Ivica G. (2011). The effect of high temperatures on the mechanical properties of concrete made with different types of aggregates. *Fire Safety Journal*, 46, 425-430.
- [9] Shah, A. H., Sharma U. K., (2017). Fire resistance and spalling performance of confined concrete columns, *Construction and Building Materials*, 156, 161-174.
- [10] Nassif, A., (2005). Postfire full stress–strain response of fire-damaged concrete, *Fire and Materials*, 30, 323–332.

- [11] Youssef, M. A., (2007). General stress–strain relationship for concrete at elevated temperatures, *Engineering Structures*, 29, 2618–2634.
- [12] Luccioni, B. M., Figueroa M. I. Danesi R. F., (2003). Thermo-mechanic model for concrete exposed to elevated temperatures, *Engineering Structures*, 25, 729-742.
- [13] Pearce, C. J., Nielsen C. V. Bicanic N., (2004). Gradient enhanced thermo-mechanical damage model for concrete at high temperatures including transient thermal creep, *International Journal for Numerical and Analytical Methods in Geomechanics*, 28, 715-735.
- [14] Ryu, E., Shin Y. Kim, H., (2018). Effect of loading and beam sizes on the structural behaviors of reinforced concrete beams under and after fire, *International Journal of Concrete Structures and Materials*, 12 (1), 1-10.
- [15] Wu, Y., Li, J., (2022). Temperature and stress of RC T-beam under different heating curves. *Journal of Building Engineering*, 46, 103620.
- [16] Kurt, Z., Tonyalı Z., (2020). Performance Analysis of a Reinforced Concrete Frame System According to TBEC-2018, *Sciennovation*, 1 (2), 6-22,
- [17] Chaudhari, D.J., Dhoot G.O., (2016). Performance based seismic design of reinforced concrete building, *Open Journal of Civil Engineering*, 6, 188-194.
- [18] SAP2000. (2019). Computers & Structures, California.
- [19] Meacham, B. J., (2016). Post-earthquake fire performance of buildings: Summary of a large-scale experiment and conceptual framework for integrated performance-based seismic and fire design, *Fire Technology*, 52(4), 1133-1157.
- [20] Hacıemiroğlu, M., (2014). Earthquake performance of R.C. buildings which exposed to fire (in Turkish), M.Sc Thesis, Istanbul Technical University, Graduate School of Science Engineering and Technology, Istanbul, Turkey.
- [21] TEC-2007, (2007). Turkish Earthquake Code. Disaster and Emergency Management Presidency, Ministry of Interior, Republic of Turkey. Turkey.
- [22] TBEC-2018, (2018). Turkish Building Earthquake Code. Rules for the Design of Buildings under Earthquake Effects. Disaster and Emergency Management Presidency, Ministry of Interior, Republic of Turkey. Turkey.
- [23] ANSYS, (2022). ANSYS Academic Research Mechanical (Version 19).
- [24] Khan, R. A., (2014). Performance based seismic design of reinforced concrete building, *International Journal of Innovative Research in Science, Engineering and Technology*, 3(6), 13495-13506.
- [25] Kumbasaroglu, A., (2020). Effect of anchor bars on seismic behavior of infilled walled frames, *KSCE Journal of Civil Engineering*, 24(10), 2980-2992.
- [26] TS-498. (2021). Design loads for buildings, Turkish Standards Institute. Turkey.

- [27] TS-500. (2000). Requirements for Design and Construction of Reinforced Concrete Structures. Turkish Standards Institute. Turkey.
- [28] TS-708. (2016). Steel for the reinforcement of concrete - Reinforcing steel, Turkish Standards Institute. Turkey.
- [29] AFAD, Available: <https://tdth.afad.gov.tr>
- [30] ISO-834. (1999). Fire-Resistance Tests—Elements of Building Constructions—Part 1: General Requirements, V. 25, International Organization Standard, Geneva, Switzerland, 25 pp.
- [31] Kumar, A., Kumar V., (2003). Behaviour of RCC beams after exposure to elevated temperatures, *Journal of the Institution of Engineers*, 84, 165-170.
- [32] Eurocode-2. (2004). Design of Concrete Structures. Part 1–2: General Rules – Structural Fire Design, European Committee for Standardization, Brussels, Belgium.
- [33] Eurocode-1. (2004). Actions on structures - Part 1-2: General actions - Actions on structures exposed to fire, European Committee for Standardization,. Brussels, Belgium.
- [34] Eurocode-4. (2005). Design of composite steel and concrete structures - Part 1-2: General rules - Structural fire design, European Committee for Standardization,. Brussels, Belgium.
- [35] Mander, J. B., Priestley M. J., Park R., (1988). Theoretical stress-strain model for confined concrete, *Journal of Structural Engineering*, 114(8), 1804-1826.