



POLİTEKNİK DERGİSİ

JOURNAL of POLYTECHNIC

ISSN: 1302-0900 (PRINT), ISSN: 2147-9429 (ONLINE)

URL: <http://dergipark.org.tr/politeknik>



Predicting fatigue life of a mount of a device with shock absorber

Şok sönümleyiciye sahip cihazın montaj arayüzünün yorulma ömrünün hesaplanması

Yazar(lar) (Author(s)): Uğur TEKECİ¹, Bora YILDIRIM²

ORCID¹: 0000-0002-1414-2443

ORCID²: 0000-0003-3293-9656

To cite to this article: Tekeci U., Yıldırım B., “Predicting fatigue life of a mount of a device with shock absorber”, *Journal of Polytechnic*, 27(3): 1005-1015, (2024).

Bu makaleye şu şekilde atıfta bulunabilirsiniz: Tekeci U., Yıldırım B., “Predicting fatigue life of a mount of a device with shock absorber”, *Politeknik Dergisi*, 27(3): 1005-1015, (2024).

Erişim linki (To link to this article): <http://dergipark.org.tr/politeknik/archive>

DOI: 10.2339/politeknik.1210934

Predicting Fatigue Life of A Mount of A Device with Shock Absorber

Highlights

- ❖ *Fatigue analyses in frequency domain*
- ❖ *Flight data acquisition*
- ❖ *Accelerated life test*

Graphical Abstract

The fatigue life of a mount of a device with shock absorber is analyzed in frequency domain and the accuracy of the analysis was proven by the experiment.

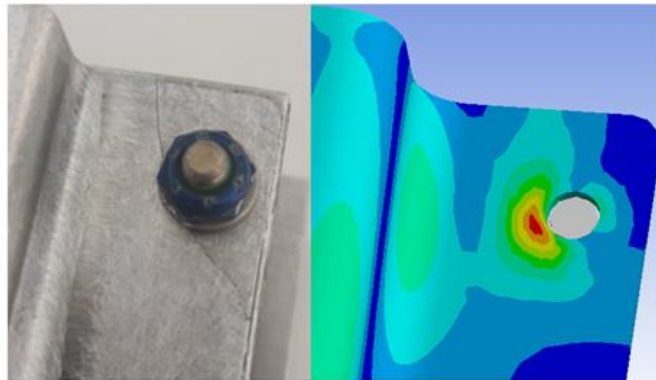

Figure. Fracture on the Mount and Finite Element Model

Aim

The main aim of this study is to investigate the fatigue life of a mount of a device with shock absorber.

Design & Methodology

Vibration tests were performed to prove the accuracy of the finite element model and to determine the damping ratios. Fatigue analyses were performed in frequency domain with three different methods and the accuracy of the analysis was proven by the experiment.

Originality

The main novelty of this study is to find the fatigue life of a part which is affected shock absorbers.

Findings

The absorbers have a huge effect on the fatigue life of the part.

Conclusion

Both Lalanne and Dirlik method gives the same difference from the accelerated test results. The Narrow Band method, on the other hand, gave the farthest result. The reason for this is that the irregularity factor of 0.398 is far from 1.

Declaration of Ethical Standards

The author(s) of this article declare that the materials and methods used in this study do not require ethical committee permission and/or legal-special permission.

Predicting Fatigue Life of A Mount of A Device with Shock Absorber

Araştırma Makalesi / Research Article

Uğur TEKECİ¹, Bora YILDIRIM²

¹Microelectronics, Guidance and Electro-Optics Business Sector, Aselsan Inc, Turkey

²Engineering Faculty, Department of Mechanical Engineering, Hacettepe University, Turkey

(Geliş/Received : 28.11.2022 ; Kabul/Accepted : 25.12.2022 ; Erken Görünüm/Early View : 09.03.2023)

ABSTRACT

All aircraft operate under vibration loads and these loads cause vibration-induced fatigue damage to the parts. Fatigue damages are dangerous because they occur suddenly without giving a warning before, for this reason they need to be carefully analyzed. In the analysis, especially the natural frequencies and dampings must be determined correctly, because when the vibration loads match with the natural frequencies, resonance is observed and this reduces the life of the part. In this study, the fatigue life of a mount of a device with shock absorber is investigated. Flight tests were carried out in real flight scenarios to provide an input for the analysis. A modal test was performed to model the shock absorbers correctly. Vibration test was performed to prove the accuracy of the prepared finite element model and to determine the damping ratios. Fatigue analyses were performed in frequency domain with a commercial software, nCode, and the accuracy of the analysis was proven by the experiment.

Keywords: Fatigue analysis, shock absorber, finite element method.

Şok Sönümleyiciye Sahip Cihazın Montaj Arayüzünün Yorulma Ömrünün Hesaplanması

ÖZ

Hava araçları titreşim yükleri altında çalışmaktadır ve bu yükler parçalarda titreşim kaynaklı yorulma hasarına sebep olmaktadır. Yorulma hasarları öncesinde bir uyarı vermeden aniden oluşması nedeniyle tehlikeli hasarlardır bu yüzden dikkatlice analiz edilmesi gerekmektedir. Analizlerde özellikle doğal frekansların ve sönümlenmelerin doğru belirlenmesi gerekir çünkü titreşim yüklerinin doğal frekanslarla çakışması durumunda rezonans gözlenir ve bu parçanın ömrünü azaltır. Bu çalışma kapsamında şok sönümleyiciye sahip bir cihazın montaj arayüzünün yorulma ömrü analiz edilmiştir. Analize girdi olması amacıyla gerçek uçuş senaryolarında uçuş testleri gerçekleştirilmiştir. Şok sönümleyicilerinin doğru modellenmesi için modal test yapılmıştır. Hazırlanan sonlu elemanlar modelinin doğruluğunu kanıtlamak ve sönümlenme oranlarının tespiti için titreşim testi yapılmıştır. Yorulma analizleri ticari bir yazılım olan nCode ile frekans düzleminde yapılmış ve analizin doğruluğu yapılan test ile kanıtlanmıştır.

Anahtar Kelimeler: Yorulma analizi, şok sönümleyici, sonlu elemanlar modeli.

1. INTRODUCTION

Dost of the machine elements consist of metallic parts and these parts generally work under cyclic or fluctuating loads. Although these loads do not cause the parts to break immediately, they can cause damage to the part after a certain amount of cycles. This is called the fatigue phenomenon in the literature.

Fatigue analysis is important to ensure that the machines will complete their specified service time without failure.

In order to determine the fatigue strength of materials, testing under different conditions is required. The life of the materials varies according to the stress ratio and amplitude. The figures below show the S/N graphs of 2024-T3 and 6061-T6 aluminum alloy taken from MIL-HDBK-5J.

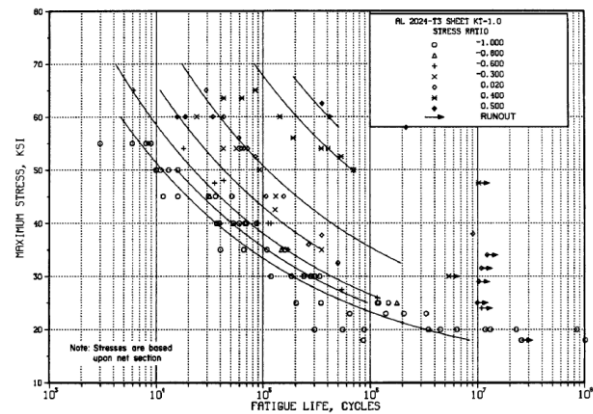

Figure 1. Unnotched 2024-T3 Aluminum Alloy S/N Curve [1]

*Sorumlu Yazar (Corresponding Author)

e-posta : utekeci@aselsan.com.tr

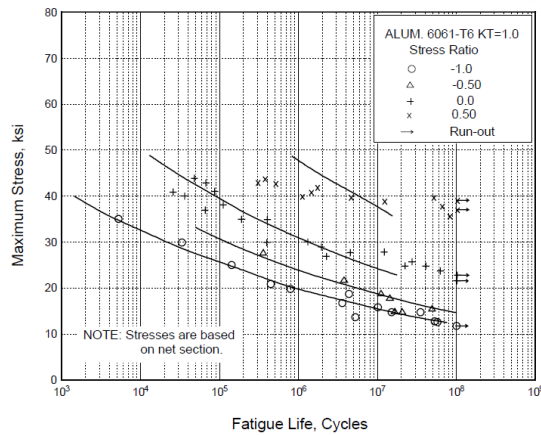

Figure 2. Unnotched 6061-T6 Aluminum Alloy S/N Curve [1]

Studies that investigate the cause of failure of materials, that happen under loadings not even exceeding the yield strength, began in the 1800s.

The first person to mention the fatigue phenomenon is the German engineer Wilhelm Albert, who investigated the failure of crane chains in mines [2]. In a lecture at the military school in Metz, Jean-Victor Poncelet described metals as "tired" materials [3]. The fatigue strength of railway axles and importance of stress concentration was discussed in 1842 by Scottish William John Macquorn Rankine [4]. In 1860, Sir William Fairbairn and August Wohler conducted the first systematic fatigue life studies. Wöhler's work on railway axles leads him to the idea of the fatigue limit and to propose the use of S-N curves in mechanical design [5]. In 1899, work on the relationship of fatigue life to mean and alternating stresses was published by Goodman [6]. Ewing shows that fatigue failure is caused by microscopic cracks, in 1903 [7]. In 1910, O. H. Basquin constructed the form of a typical S-N curve [8]. In 1924, Englishman Gough published the first fatigue book [9]. An article published on damage accumulation hypotheses for fatigue life by Palmgren in 1924 [10]. The linear damage hypothesis was first published by A. Palmgren in 1924 and was further popularized by M. Miner in 1945 [11]. In 1954, L. F. Coffin and S. S. Manson's performed studies on the relationship between plastic strain and fatigue life in the low-cycle high-strain fatigue regime. [12] [13]. Studies on the growth of cracks due to variations in loads were published by Paris in 1962 [14]. The Rainflow-Counting algorithm was developed by Tatsuo Endo and M. Matsuishi in 1968. It became the first accepted method to extract closed loading reversals or cycles. [15]. The phenomenon of crack closure was first discovered by Elber in 1970 [16].

Rice published a correlation between spectral moments of stress PSD and upward mean crossings peaks [17].

In 1964, Bendat [18] presented the Probability Density Function. This method, which gives good results for narrow bands, is very conservative for wide bands.

Many methods have been developed to correct this conservatism. Tunna [19], Wirsching [20] and

Chaudhury & Dover [21] have presented methods in order to improve Bendat's narrowband method. Also, Steinberg proposed three-band technique which is a simplified fatigue life prediction procedure for electronic components [22].

Dirlik [23] proposed an empirical closed form expression using Monte Carlo technique and computer simulations. This expression gives the probability density function of rainflow ranges. In wideband and narrowband signals, Dirlik's method gives accurate results and used in many fatigue life studies.

Bishop [24] performed some studies frequency and time domain-based fatigue techniques in finite element environment. Instead of the time domain methods, Frequency domain methods, which requires much shorter time, using the random vibration theory can be used.

Aykan [25] analyzed a bracket which is belong to a helicopter's self-defense system's chaff/flare dispenser by using vibration fatigue method. From operational flight tests, acceleration power spectral density is obtained. FE model of the bracket is constructed to get stress power spectral density. The finite element model has been verified by the results obtained from the experiments.

Eldogan [26] presented a numerical code which can calculate the fatigue life of parts both in frequency domain and time domain. Flight data is acquired from the aircraft and analyzes are performed with this data.

Akgumus Gok and Baltaci [27] performed stress analysis of Z type parabolic leaf spring with finite element analysis method and determined high stress regions of this leaf spring. The fatigue life of the component has been obtained with the N-Code and physical tests.

Akyildiz et al. [28] experimentally investigated the effects of anodic coating on the fatigue strength of AA7050-T7451 alloy. S-N fatigue curves created with the help of the test data and Weibull equation showed that the anodic treatment significantly affected the fatigue performance of the alloy.

Koken and Karabulut [29] investigated the applicability of elastomeric vibration insulators in order to reduce the vibration problem of the milling machine from the machine tools.

2. FLIGHT DATA ACQUISITION

For the fatigue analysis to give more realistic results, flight tests were performed to obtain vibration data from the aircraft. In the flight tests, data were collected during all maneuvers and flight conditions of the aircraft, and these data were then synthesized. The durations of the flight conditions and the values of PSD graphs are not given due to military confidentiality.

Table 1. Flight Conditions and Durations

Flight Condition	Duration [h]	Life Duration [h]
Ground Idle	t_1	$T_1 = T_{total} * \left(\frac{t_1}{t_{total}}\right)$
Ground Max Rotor RPM	t_2	$T_2 = T_{total} * \left(\frac{t_2}{t_{total}}\right)$
Climbing	t_3	$T_3 = T_{total} * \left(\frac{t_3}{t_{total}}\right)$
Cruise Speed	t_4	$T_4 = T_{total} * \left(\frac{t_4}{t_{total}}\right)$
Max Speed	t_5	$T_5 = T_{total} * \left(\frac{t_5}{t_{total}}\right)$
Sharp Turn	t_6	$T_6 = T_{total} * \left(\frac{t_6}{t_{total}}\right)$
Hover IGE	t_7	$T_7 = T_{total} * \left(\frac{t_7}{t_{total}}\right)$
Hover OGE	t_8	$T_8 = T_{total} * \left(\frac{t_8}{t_{total}}\right)$
Hover Turn	t_9	$T_9 = T_{total} * \left(\frac{t_9}{t_{total}}\right)$
Descend and Landing	t_{10}	$T_{10} = T_{total} * \left(\frac{t_{10}}{t_{total}}\right)$
Total Flight Duration	$t_{total} = \sum_{i=1}^{11} t_i$	$T_{total} = 2500 \text{ h}$

During a usual mission of the aircraft, all stages must last a certain amount of time under standard circumstances. It is denoted by t_i where i corresponds to each stage and the duration of the stages corresponds to whole operational life is indicated by T_i . In accordance with military standard, the period during which the aircraft will operate during its entire life can be considered as 2500 hours. That is why T_{total} is assumed to be 2500 hours.

The operational flight data, acquired from the aircraft of each condition, can be combined to obtain a single PSD data as specified by the equation given below according to the MIL-STD-810G Method 514.6 Annex A [30].

$$T_{total} G_{total}^{m/2} = T_1 G_1^{m/2} + T_2 G_2^{m/2} + \dots + T_N G_N^{m/2} \tag{1}$$

(Where T_1, T_2, T_N are the time durations of all stages given in Table 1, G_1, G_2, G_N is the PSD value of each phase. It suggests taking "m" as 80 percent of the slope of S/N curve for random waveshapes. Historically $m = 7.5$ has been used, with 5 to 8 usually being used for random vibration [30].

The data sampling frequency is 8000 Hz. Collected vibration data is converted to g from mV using reference sensitivities in the sensor manuals. These data in the time domain are transformed into the frequency domain by Welch's power spectral density estimates. The transformation is done with the "pwelch" command in Matlab. The PSD is obtained up to 4000 Hz due to the Nyquist theorem and the frequency resolution of the PSD

data is set to 0.244 Hz. For each axis 2500 hours of acceleration PSDs which were obtained from flight tests are provided in Figure 3.

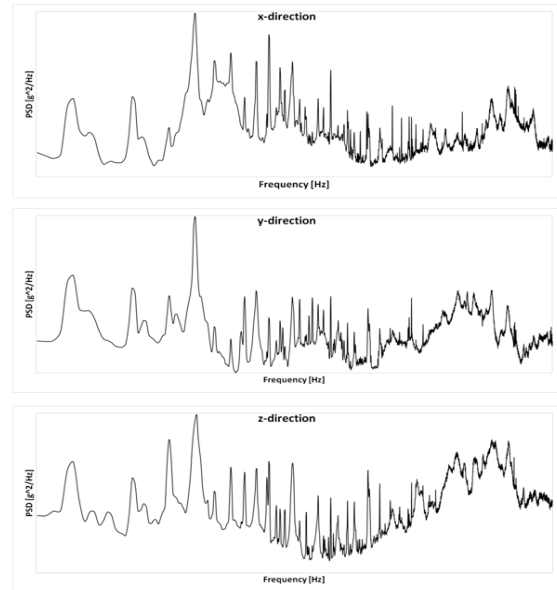

Figure 3. Acceleration PSD's

Since the loading conditions are multiaxial, the multiaxial theory should be applied. On the other hand, in this study, since the electromagnetic shaker system is not capable of providing simultaneous multi-axis loading, all analyzes will be carried out with single axis acceleration PSD input so that the analyzes can be verified by experiments. An enveloping method is preferred to be on the safe side. To obtain a single axis acceleration PSD, maximum value at each frequency of each direction is used.

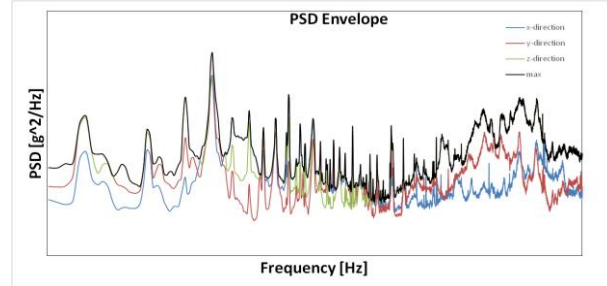

Figure 4. PSD Envelope

Vibration data that were obtained from the aircraft were taken only once. The reason for this is that all measurements to be made have the same mean value because the vibration characteristic is ergodic random. Ergodic random process means that the time averages of the process tend to be the appropriate ensemble averages. This shows that the PSD graph to be created will not change even if the measurements are repeated.

The 2500-hour period, which represents the platform's entire lifetime, is used to obtain the lifetime of the components in finite element analysis. On the other hand, an experimental fatigue analysis with 2500 hours of data

is not possible. As a result, by accelerating 2500 hours of PSD data into 4 hours with same damage values at the end of the duration, the analysis can be possible. Then, the equation from MIL-STD-810G Method 514.6 Annex A is used as follows,

$$T_4 G_4^{m/2} = T_{2500} G_{2500}^{m/2} \quad (2)$$

Here, G_4 is the 4 hours PSD, G_{2500} is the enveloped 2500 hours PSD, T_{2500} is 2500 hours, T_4 is 4 hours and m is the scaling factor. The value of m is 7.5, which is the suggested value in the standard for random environments.

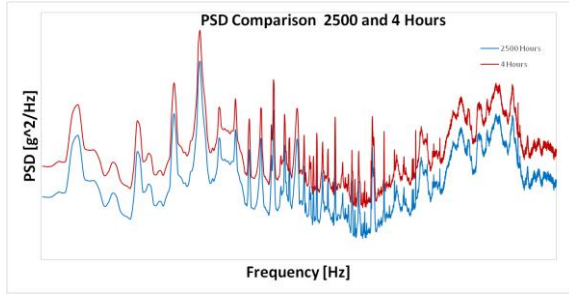

Figure 5. PSD Comparison for 2500 and 4 Hours

3. VIBRATION FATIGUE ANALYSIS AND VERIFICATION

3.1. Finite Element Model Preparation

Since the finite element model directly affects the result of the fatigue analysis, it needs to be carefully prepared. The avionics unit contains many electronic boards and components and each of them have their own natural frequencies. In order not to see peaks at these frequencies in the verification tests, the avionic unit is modeled as an aluminum block with equivalent weight.

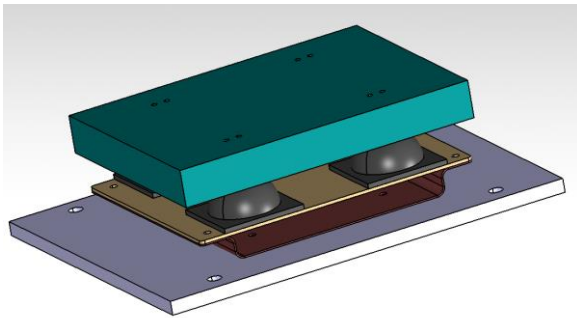

Figure 6. CAD Model of Test Setup

In finite element analysis, thin-walled structures are modeled with shell elements to increase computational efficiency. For sheet metal parts whose thickness is lower compared to their large surface area, a mid-surface is formed. After this process, two-dimensional surfaces are created geometrically, and then the analysis model is prepared by creating a mesh structure on this surface.

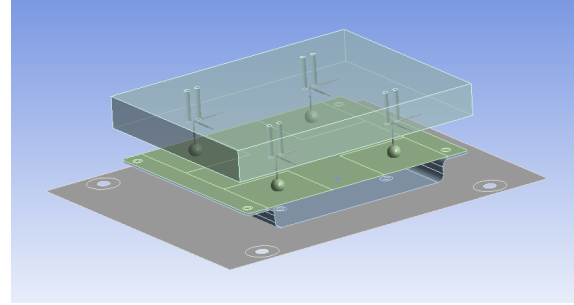

Figure 7. Simplified ANSYS Model

The shock absorbers are modeled as 3-axis springs and their weights are added as point masses. In this study, the absorbers are studied only as an element that changes the dynamic characteristics of the structure. The life of the absorbers were not investigated. It has been assumed that the performance of the absorber does not change with factors such as temperature, abrasion, etc. throughout the tests and analyzes.

Aluminum 6061 T6 is assigned to the avionics unit and its tray, and Aluminum 2024 T3 is assigned to the mount. All materials were selected from nCode material library which provides S/N curves of the materials.

The aluminum block that represents the avionics unit is roughly meshed, since the meshing of the block has an insignificant result on the modes of the mount. On the other hand, adjustments have been made to improve the quality of the mesh of other parts. Sizing of the mesh continuously decreased until the stress value does not change. This method, called mesh convergence analysis, provides the required accuracy with the minimum number of mesh and shows whether there is singularity or not.

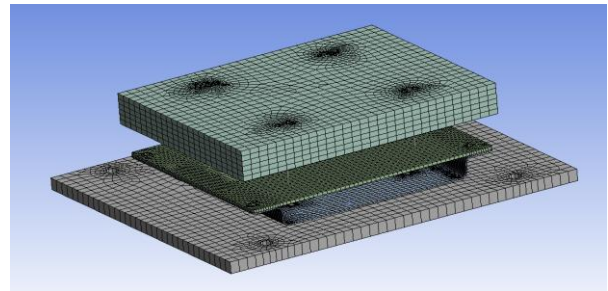

Figure 8. Meshed Model

ve 20 Bins'lik değeri görülmektedir. Şekil 15'e göre, %70'lik veriyi 0 hata ile, %10'luk veride 0.0017'lik hata ile ve geri kalan %20'lik verilerde ise % 0.002 ile %0.009 hata payları olduğu gözlemlenmiştir. Şekil 16'da ise %80'e yakın verilerde 0 hata, geri kalan % 20'lik kısımda ise en büyüğü %0.0026 olan hata payı olduğu görülmektedir.

3.2. Absorber Model

In the analysis, 3-axis spring connection is used to model the dynamic characteristic of the absorber. A test was

performed in 3 axes with an electromagnetic shaker to obtain the stiffness and damping values of the spring connection. The test was performed with 0.002 g2/hz white noise and 4 accelerometers were used to obtain the response of the structure. Only shock absorbers and block are used in this test.

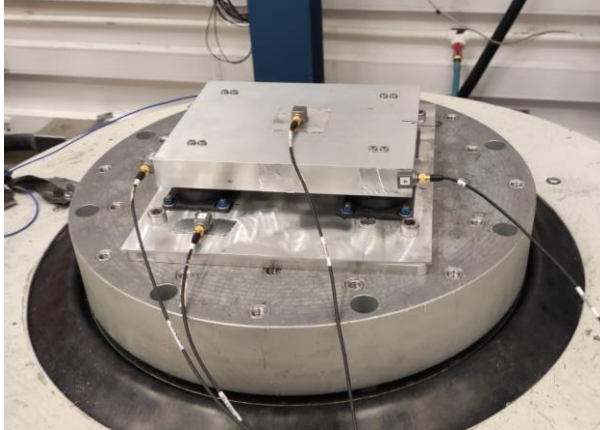

Figure 9. Test for Obtaining the Absorber Characteristics

Table 2. Components of Test Setup

Data Acquisition Unit	Acra KAM-500
Accelerometer	Bruel & Kjaer 4535-B-001
Software	IADS Quicklook
Shaker	LDS V8-440

The stiffness and damping values were obtained using the test results. According to the test, stiffness of the absorbers is 8700 N/m in 3 axis and the damping ratio is 0.17. The damping ratio was calculated using the half-power bandwidth method. These values were used in the spring connection and the analysis results were compared with the test results.

Table 3. Comparison of Natural Frequencies

Direction	Experiment Natural Frequency [Hz]	Analysis Natural Frequency [Hz]	Damping Ratios
x	16.1	15.9	0.14
y	17.6	16.9	0.13
z	16.5	16.5	0.17

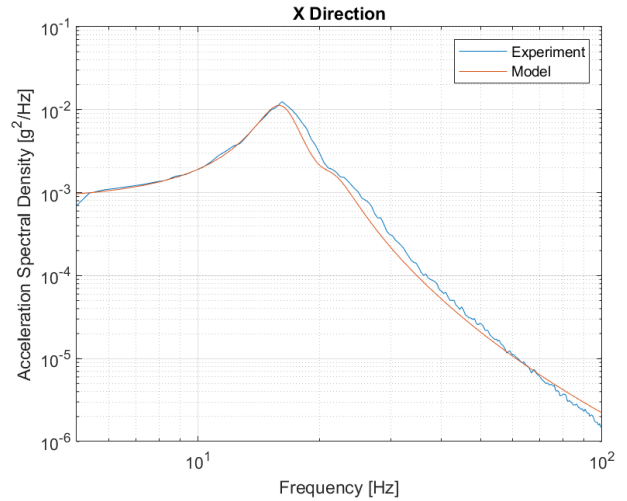

Figure 10. PSD Comparison for Model and Test Results in X-Direction

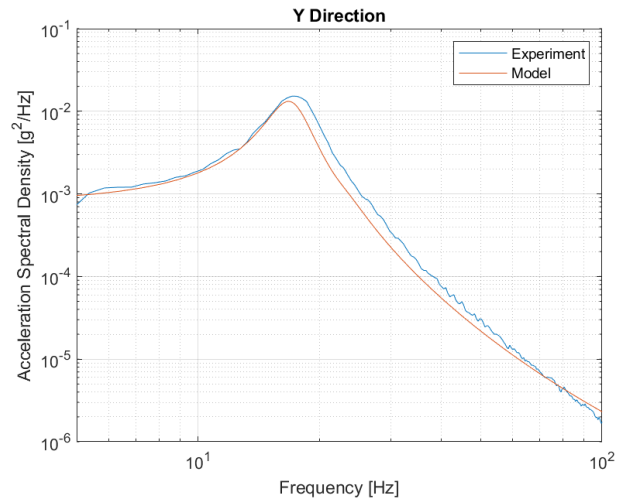

Figure 11. PSD Comparison for Model and Test Results in Y-Direction

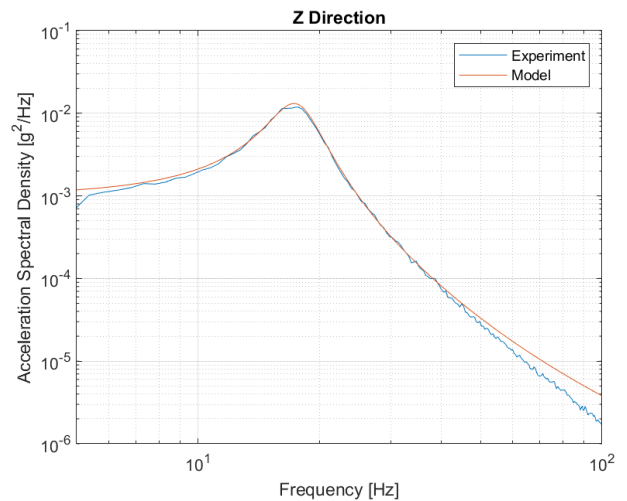

Figure 12. PSD Comparison for Model and Test Results in Z-Direction

The experiment was repeated in z axis at different amplitudes to understand whether the absorber works

linearly. The transmissibility plots of the tests and damping ratios are given below.

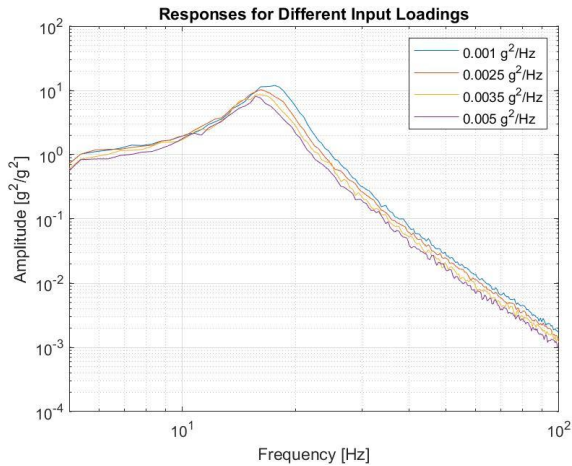

Figure 13. Responses for Different Input Loadings

Table 4. Experiment Amplitudes and Corresponding Damping Ratios

Experiment Amplitude [g²/Hz]	Damping Ratio
0.001	0.16
0.0025	0.17
0.0035	0.17
0.005	0.16

Table 4 shows that, with changing input amplitude natural frequency of the absorber change slightly. The damping ratios also do not change much. It can be assumed that there isn't a non-linearity in the absorber dynamics.

3.3.Finite Element Model

After the verification of the absorber models, the model of the whole system was prepared. All bolts in the system are modelled with deformable structural steel beam element. Changing contact types and contact areas changes the natural frequencies as well. Therefore, modal testing was performed to determine the correct type of contact and the diameter of the contact area.

In order to test the precision of the FEM and to determine the damping ratios, random vibration analysis and test with 0.002 g²/hz white noise were performed and the results were compared. Damping ratios were calculated using the half-power bandwidth method.

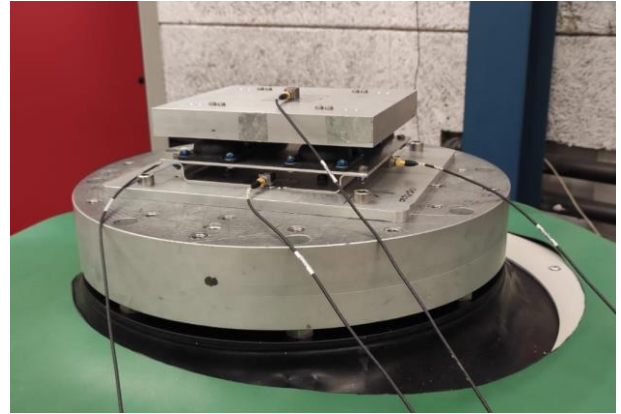

Figure 14. White Noise Vibration Test

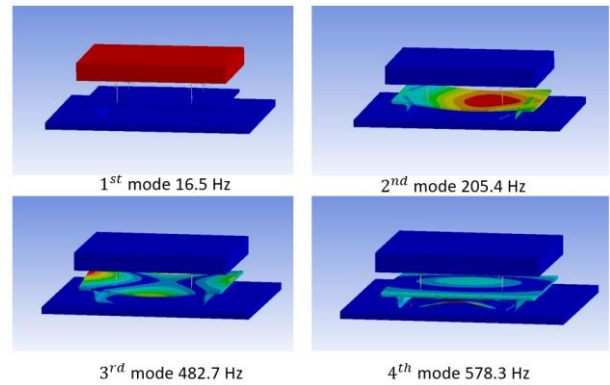

Figure 15. Mode Shapes of Structures

The comparison of analysis and test results is given below.

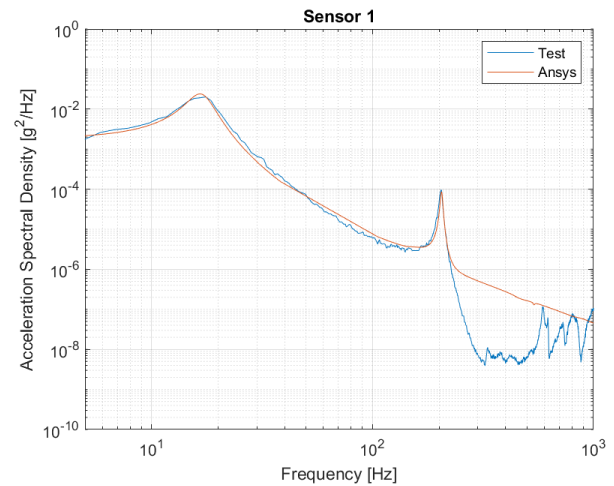

Figure 16. Sensor 1 Test vs ANSYS Comparison

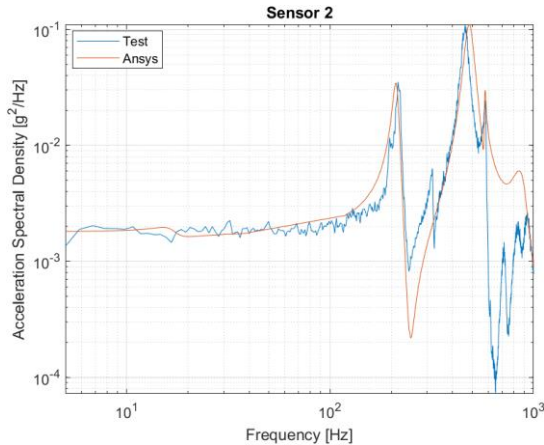

Figure 17. Sensor 2 Test vs ANSYS Comparison

In Table 5, natural frequencies acquired from the tests and finite element model and their corresponding damping ratios are given. Comparison shows that the first four natural frequencies acquired from tests and finite element model are very close to each other.

Table 5. Comparison of Natural Frequencies and Damping Ratios

Mode Number	Experiment Natural Frequency [Hz]	Analysis Natural Frequency [Hz]	Damping Ratios
1	16.6	16.5	0.17
2	204.1	205.4	0.015
3	460.9	482.7	0.039
4	578.1	578.3	0.018

nCode gets the FRF data from harmonic analysis. Therefore finite element model was used for mode superposition harmonic analysis which uses natural frequencies obtained by modal analysis. 1g acceleration load is used to be compatible with power spectral density.

3.4.Fatigue Life Analysis

ANSYS Random Vibration Analysis can not work with the damping coefficient written in the spring connection. The damping ratio can be inputted into the analysis settings, but in this case damping is applied to the whole structure. MSUP harmonic analysis can use this damping coefficient with the reduced damped solver. nCode takes FRF data from harmonic analysis, so it is more suitable for fatigue life analysis of the structure.

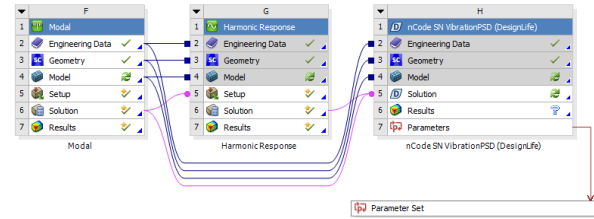

Figure 18. ANSYS Workbench – Ncode analysis construction

nCode has its own material library and the parts to be analyzed must be selected from this library. nCode uses glyphs for solvers, functions, inputs, and outputs. PSD data is given into the Vibration Generator glyph as an Excel spreadsheet.

nCode can perform analysis with Lalanne, Dirlik, Narrow Band and Steinberg methods. The Steinberg method was not used in the analysis because it focused on electronic components. The other three methods were used to find the fatigue life, and the results were compared with each other.

In the comparison made in Table 6, the damages caused by the input PSD in one second and fatigue lives are given. The value of RMS Stress is the same for all methods as it is not dependent on the cycle counting method.

Table 6. Fatigue Life Analysis Results for 2500 Hours PSD

Cycle Counting Method	RMS Stress [Mpa]	Damage	Life [s]
Lalanne	12.8	1.602e-12	6.242e+1 1
Dirlik	12.8	1.788e-12	5.593e+1 1
Narrow Band	12.8	3.170e-12	3.155e+1 1

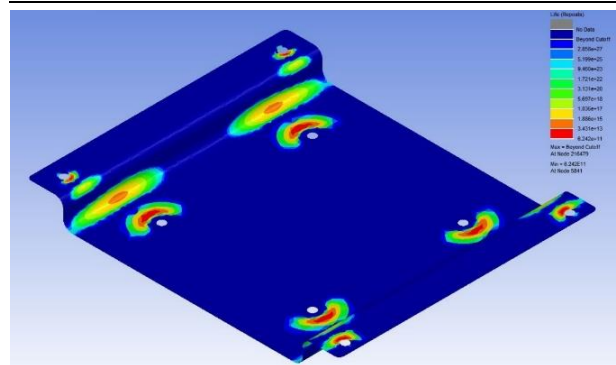

Figure 19. Lalanne Method Fatigue Life Result

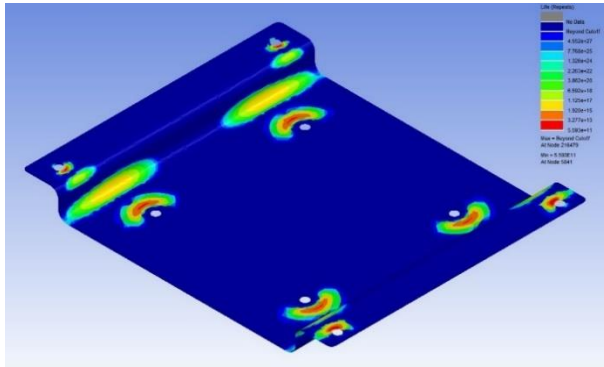

Figure 20. Dirlik Method Fatigue Life Result

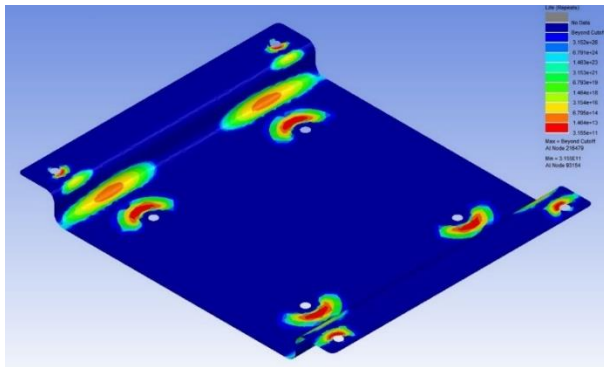

Figure 21. Narrow Band Method Fatigue Life Result

The stress PSD graph obtained by using the FRF and input power spectral density is given in Figure 22. The graph shows that the amplitudes of the stresses in the structure are quite low.

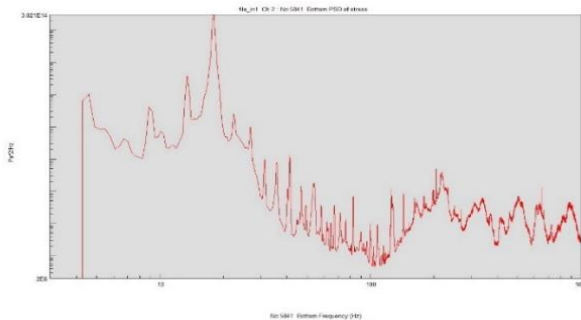

Figure 22. Stress PSD for 2500 Hours Input PSD

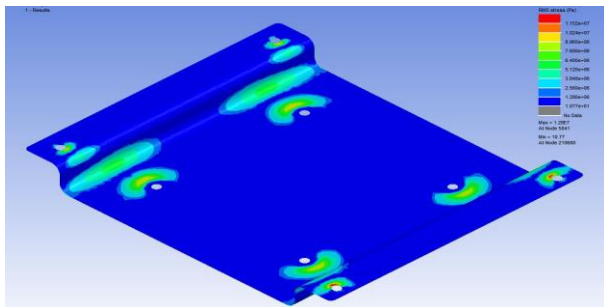

Figure 23. RMS Stesses for 2500 Hours Input PSD

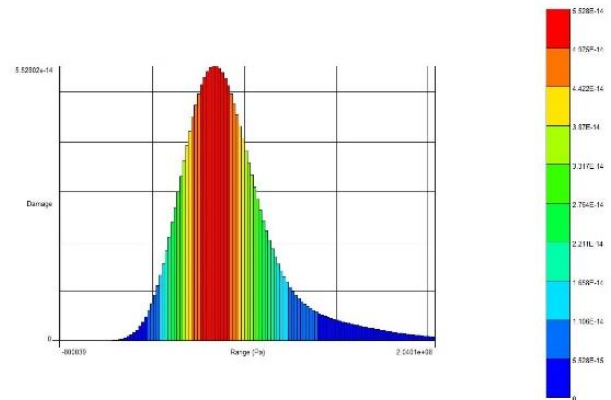

Figure 24. Dirlik Method Damage Histogram

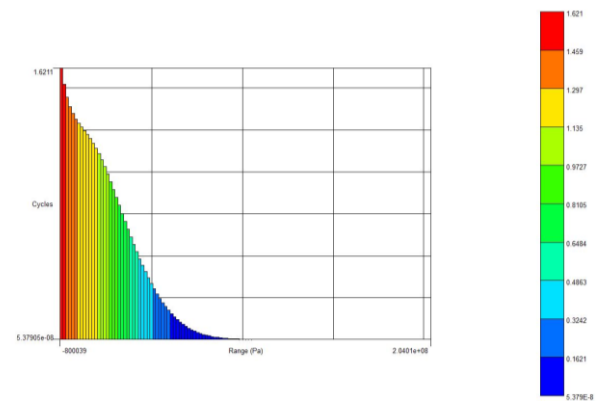

Figure 25. Dirlik Method Cycle Histogram

3.5. Accelerated Life Test

In order to determine the accuracy of the analysis results, they must be compared with the test results. For this purpose, 2500 hours' data is accelerated to 4 hours, as it is suggested in the military standard. The PSD profile is obtained as given in Figure 5. Fatigue life analyzes were repeated for this profile and the results are given below.

Table 7. Fatigue Life Analysis Results for 4 Hours PSD

Cycle Counting Method	RMS Stress [Mpa]	Damage	Life [s]
Lalanne		5.545e-9	1.804e+08
Dirlik	30.2	5.973e-9	1.674e+08
Narrow Band		1.476e-8	6.773e+07

The fatigue life of the part still has not reached the practical test duration, i.e. the time required for damage to be observed is still very high.

A new PSD was created to excite the natural frequencies of the mount, as amplifying the flight data enough to be used in tests would exceed the shaker's limits, and the amplification at low frequencies could damage the absorber. The analysis was repeated using this PSD.

Table 8. Fatigue Life Analysis Results for Test PSD

Cycle Counting Method	RMS Stress [Mpa]	Damage	Life [s]
Lalanne		1.046e-4	9561
Dirlik	68.5	7.516e-5	13300
Narrow Band		2.548e-4	3925

As a result of the test, which is performed to observe the fatigue life and compare with the analysis results, the part was damaged after 191 minutes. Both Lalanne and Dirlik method gives the same difference from the test results. The Narrow Band method, on the other hand, gave the farthest result. The reason for this is that the irregularity factor of 0.398 is far from 1. In order to understand whether the characteristic of the signal shows narrowband or wideband characteristics, the irregularity factor is checked. Since the irregularity factor is closer to 0 than 1, which does not show narrowband characteristics.

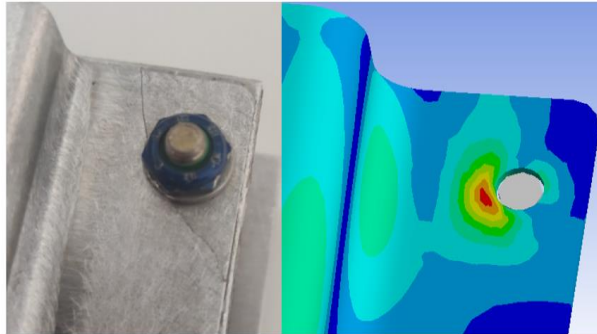

Figure 26. Fracture on the Mount and Finite Element Model

3.6.Case Study I

To see the effect of the absorbers on the life of the mount, the system is reconstructed without the absorber. The aluminum block is modeled as a point mass with the same weight and inertia. The contact surfaces were not changed and the damping coefficient was assumed to be 0.02 for all modes. Fatigue life analyzes were repeated for the 2500 hours profile and the results are given in Table 9.

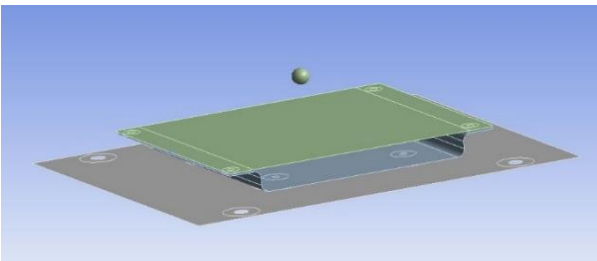

Figure 27. ANSYS Model of the System Without Absorbers

Table 9. Fatigue Life Analysis Results for the Mount Without Absorbers

Cycle Counting Method	RMS Stress [Mpa]	Damage	Life [s]
Lalanne		4.039e-4	2476
Dirlik	82.09	3.298e-4	3032
Narrow Band		4.826e-4	2072

When the system is reconstructed without the absorber, the natural frequencies of the new system are different from the original one. Since this modification affects the FRF data, the results of the fatigue life analysis, which is performed with the same input PSD, change.

3.7.Case Study II

2500 hours of PSD data are accelerated to 4 hours with using Equation (15). The value of *m* which is the scaling factor, used as 7.5, which is the recommended value in the standard for random environments. However, this *m* value is not provide same damage value with original PSD. To fix this undesirable situation, the value *m* is increased until the same damage is achieved.

Table 10. Fatigue Life Analysis Results for Diffrent *m* Values

<i>m</i>	Duration [h]	gRMS	Damage	RMS Stress [MPa]
-	2500	0.66	1.442e-5	12.8
7.5	4	1.55	7.985e-5	30.2
9.5	4	1.30	1.442e-5	25.2

Table 10 shows that *m*=7.5 value in the military standard will give more conservative results. The value of “*m*” is strongly influenced by the material S-N curve and this curve is not a linear plot. When the stresses used by Miner's theorem change, the area used in the S/N curve and the slope of the curve are also changes. Therefore, the value of *m* depends on the stress level of the structure and the S/N curve of the material.

4. CONCLUSION AND DISCUSSION

In this study, the fatigue life of a mount of a device with shock absorber is investigated with the real vibration data from flight conditions. All stages of the analysis have been verified by different tests. Fatigue life is calculated using three different methods because it is not known which method will give more accurate results without testing.

Vibration data that were measured from the aircraft were taken only once. The reason for this is that all measurements to be made have the same mean value because the vibration characteristic is ergodic random.

This shows that the PSD graph to be created will not change even if the measurements are repeated.

In this study, the absorber is studied only as an element that changes the dynamic characteristics of the structure. The life of the absorber was not investigated. It has been assumed that the performance of the absorber does not change with factors such as temperature, abrasion, etc. throughout the tests and analyzes.

The use of the avionics unit itself in the tests was not preferred as it would cause the modes of the electronic board, components and other mechanical parts inside the device to appear in the results. Instead, an aluminum block of the same weight was used in the tests.

Since the material of the absorber has non-linear characteristics, it is not suitable to use in modal analysis. Instead, the absorber was modeled using spring connections on 3 axes. The spring connection uses the stiffness and damping coefficients. In order to obtain these values, a test setup containing only the absorber and the block was prepared. The necessary values were found from the results of the vibration test performed with this setup. The stiffness of the system was found using the natural frequency and mass of the system, and the damping coefficient was calculated with the Half-Power Method over the FRF data.

While preparing the finite element model of the whole system, a vibration test was performed using a shaker to accurately determine the diameters of the connection types and connection areas. To match the natural frequencies found as the result of the test, a parametric study was carried out with the connections. The study showed that the variation of connection types and connection areas greatly affects natural frequencies.

With the FRF data obtained from the test, damping ratios were obtained for all modes. These damping ratios were entered into the analysis separately for each natural frequency.

For the damping value written in the spring connection to be used in the MSUP harmonic analysis, the reduced damped solver must be used.

Damping ratios significantly affect the stresses occurring at natural frequencies. Small changes in stresses also affect the life of the parts considerably due to the nature of the S/N curve. However, one of the difficulties in determining the damping ratios is that the damping ratio changes according to the level of the excitation.

ANSYS Random Vibration Analysis module is not suitable for fatigue analysis. The reason is that the element damping used in the spring connection can not work with Random Vibration. That's why nCode is used which gets the FRF data from MSUP Harmonic Analysis.

Fatigue analyzes were first performed with the vibration data measured from the aircraft. Since it was not possible to test with the results obtained, 2500 hours of data were accelerated to 4 hours with the equations given in MIL-STD-810 to see the damage in the parts during the test

period. However, the time required for damage to be observed is still very high.

A new PSD was created to excite the natural frequencies of the mount, as amplifying the flight data enough to be used in tests would exceed the shaker's limits, and the amplification at low frequencies could damage the absorber. The analysis was repeated using this PSD and verified by testing. As a result of the test performed to observe the fatigue life and compare with the analysis results, the part was damaged after 191 minutes. Both Lalanne and Dirlik method gives the same difference from the test results. The Narrow Band method, on the other hand, gave the farthest result. The reason for this is that the irregularity factor of 0.398 is far from 1.

When 2500 hours of data are accelerated to 4 hours, the value of m which is the scaling factor, used as 7.5, which is the recommended value in the standard for random environments. However, this m value is not provide same damage value with original PSD. To fix this undesirable situation, the value m is increased until the same damage is achieved.

All parts contain a certain amount of imperfections and since the mount is a sheet metal produced by bending, there are cambers on the part and this situation creates uncertainty in the analysis. In addition, the change in the damping characteristic of the system according to the input increases the uncertainty. Considering all these, the results obtained within the scope of this study are satisfactory.

DECLARATION OF ETHICAL STANDARDS

The authors of this article declare that the materials and methods used in this study do not require ethical committee permission and/or legal-special permission.

AUTHORS' CONTRIBUTIONS

Uğur TEKECİ: Performed the experiments, analyzed the results, and wrote the manuscript.

Bora YILDIRIM: Analyzed the results and wrote the manuscript.

CONFLICT OF INTEREST

There is no conflict of interest in this study

REFERENCES

- [1] MIL-HDBK-5J, "Metallic Materials and Elements for Aerospace Vehicle Structures", (2003).
- [2] Albert W.A.J., "Über Treibseile am Harz.", Archiv für Mineralogie, Geognosie, Bergbau und Huttenkunde, Berlin, (1837).
- [3] [https://en.wikipedia.org/wiki/Fatigue_\(material\)](https://en.wikipedia.org/wiki/Fatigue_(material)),
- [4] Rankine W.J.M., "On the causes of the unexpected breakage of the journals of railway axles, and on the means of preventing such accidents by observing the law

- of continuity in their construction”, *Journal of the Franklin Institute*, 36: 178-180, (1843).
- [5] Schütz W., “A history of fatigue”, *Engineering fracture mechanics*, 54: 263-300, (1996).
- [6] Goodman J., “Mechanics Applied To Engineering”, *Longmans, Green and Co. John*, London, (1899).
- [7] Ewing, J. A., and J. C. W. Humfrey, “The Fracture of Metals under Repeated Alternations of Stress”, *Philosophical Transactions of the Royal Society of London*, 200: 241-250, (1903)
- [8] Basquin O., “The exponential law of endurance tests”, *American Society for Testing and Materials Proceedings*, 10: 625-630, (1910).
- [9] Gough H., “The Fatigue of Metals”, *Scott, Greenwood and Son*, London, (1924).
- [10] Palmgren A., “Die lebensdauer von kugellagern”, *Zeitschrift des Vereines Duetsher Ingenieure*, 68: 339-341, (1924).
- [11] Miner M., “Cumulative fatigue damage”, *Journal of applied mechanics*, 12: A159-A164, (1945).
- [12] Coffin Jr L.F., “A study of the effects of cyclic thermal stresses on a ductile metal”, *Transactions of the ASME*, 76:931-950, (1954).
- [13] Coffin Jr L.F., “The problem of thermal stress fatigue in austenitic steels at elevated temperatures”, *Symposium on Effect of Cyclic Heating and Stressing on Metals at Elevated Temperatures*, United States, 31-52, (1954).
- [14] Paris P., “The growth of cracks due to variations in load” *Ph. D. Thesis*, Lehigh University, (1962).
- [15] Matsuishi, M., & Endo, T., “Fatigue of metals subjected to varying stress”, *Japan Society of Mechanical Engineers*, 68: 37-40, (1968).
- [16] Elber W., “The significance of fatigue crack closure, Damage tolerance in aircraft structures”, *Damage Tolerance In Aircraft Structures Annual Meeting*, Toronto, 230-242, (1971).
- [17] Rice S.O., “Mathematical analysis of random noise”, *The Bell System Technical Journal*, 23: 133-294, (1954).
- [18] Bendat J.S., “Probability functions for random responses: prediction of peaks, fatigue damage, and catastrophic failures”, (1964).
- [19] Tunna J., “Fatigue life prediction for Gaussian random loads at the design stage”, *Fatigue & Fracture of Engineering Materials & Structures*, 9: 169-184, (1986).
- [20] Wirsching P.H., Light M.C., “Fatigue under wide band random stresses”, *Journal of the Structural Division*, 106: 1593-1607, (1980).
- [21] Chaudhury G., Dover W., “Fatigue analysis of offshore platforms subject to sea wave loadings”, *International Journal of Fatigue*, 7:13-19, (1985).
- [22] Steinberg D.S., “Vibration analysis for electronic equipment”, *John Wiley & Sons*, (2000).
- [23] T. Dirlik, “Application of computers in fatigue analysis”, *Ph. D. Thesis*, University of Warwick, (1985).
- [24] Bishop N.W., Sherratt F., “Finite element based fatigue calculations”, *NAFEMS*, (2000).
- [25] M. Aykan, “Vibration fatigue analysis of equipments used in aerospace”, *MS Thesis*, Middle East Technical University, (2005).
- [26] Eldoğan Y., Vibration fatigue analysis of structures installed on air platforms, *MS Thesis*, Middle East Technical University, (2012).
- [27] Akgümüş Gök, D. , Baltacı, A. “Design and Fatigue Life Analysis of Air Suspension Z Type Leaf Springs Used in Heavy Commercial Vehicle”, *Politeknik Dergisi*, 1-1, (2023) .
- [28] Akyıldız, U. , Poyrazoğlu, O. , Demirel, M. Y. “Anodik Oksidasyonun AA7050-T7451 Alaşımının Yorulma Performansına Etkisi”, *Politeknik Dergisi*, 1-1, (2023) .
- [29] Köken, A. , Karabulut, A. "Takım Tezgâhlarında Titreşim Sönümlenici Kullanılarak Zemine İletilen Kuvvetin Azaltılması". *Politeknik Dergisi*, 25: 399-404, (2022).
- [30] MIL-STD-810G, “Environmental Engineering Considerations and Laboratory Tests”, (2008).