

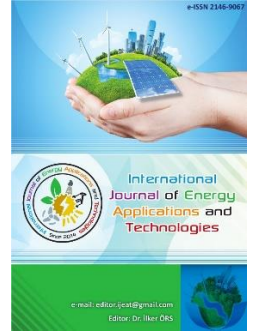

e-ISSN: 2548-060X

## International Journal of Energy Applications and Technologies

journal homepage: <https://dergipark.org.tr/en/pub/ijeat>

Original Research Article

### Using solar energy in galvanic anode cathodic protection systems

 Niyazi Karabacak\*,  Abdulhakim Karakaya

Department of Energy System Engineering, Faculty of Technology, Kocaeli 41001, Türkiye



#### ARTICLE INFO

\* Corresponding author  
[niyazi2543@gmail.com](mailto:niyazi2543@gmail.com)

Received January 31, 2023  
Accepted March 2, 2023

Published by Editorial Board  
Members of IJEAT

© This article is distributed by  
Turk Journal Park System under  
the CC 4.0 terms and conditions.

doi: 10.31593/ijeat.1245454

#### ABSTRACT

Many of the materials we use in our daily life are obtained from the mineral ores found naturally in the soil in the form of salt and oxide. When a processed metallic material is in an electrolyte environment, it tries to return to its pure state (corrosion). Underground gas, oil and water etc. Various methods are used to protect pipelines against corrosion. In the cathodic protection system with galvanic anode, which is one of these methods, the required protection current is provided by the galvanic anodes. However, as long as these anodes protect under the ground or in water, they lose their mass over time because they give electric current to the metal structure and after a while, these anodes become dysfunctional. Since the replacement of galvanic anodes causes high cost and time loss, the life of the anodes should be extended. For this reason, a method that extends the life of the anodes used in cathodic protection systems with galvanic anodes was used in the study. This method is a system that uses solar energy, which is one of the renewable energy sources. With this system used, the life of the anode was extended by providing cathodic protection. Finally, the results were analyzed by comparing the designed system with the standard systems.

*Keywords:* Anode, Cathode, Cathodic protection, Corrosion, Metal, Solar energy

#### 1. Introduction

Corrosion; are metal losses that occur as a result of chemical and electrochemical reactions of metals. Metals are highly affected by corrosion. While the economic loss caused by corrosion is 1% of the GNP in developed countries, this rate reaches 5% in underdeveloped and developing countries [1]. The degree of this corrosion varies according to the environmental conditions, type of material, chemical and electrochemical properties [2]. It has been stated by experts that corrosion loss on a global scale can be reduced by 15-35% annually by preventing corrosion in metals with various applications [3]. A significant part of the losses caused by the corrosion of metal materials can be prevented by taking the necessary precautions.

The cathodic protection system is an electrochemical method used to prevent or control the corrosion of metallic structures buried in the ground or in liquid. This method is used in many

areas today to protect metals against corrosion. For example, cathodic protection is used in underground fuel storage tanks, ground level tank bottoms, fuel and oil distribution systems, interiors of liquid storage tanks, drinking water distribution systems, natural gas distribution systems, compressed air distribution systems, fire systems, sewage systems, marine docks and pier steel piles. In this system, electric current is needed to control corrosion. If the electrical current required for protection is interrupted, corrosion will continue to progress at normal values. When sufficient protection current is provided in the cathodic protection system, the current potentials of the metals generally remain constant compared to the previous state. However, excessive changes in these currents or potentials may cause a malfunction in the cathodic protection system [4].

Various studies have been carried out in order to use solar energy while applying cathodic protection to underground

pipes. When the studies on cathodic protection are examined; in external current sourced cathodic protection systems, studies have been carried out to use electricity produced from solar panels instead of mains electricity [5], [6]. In addition, a mini cathodic protection system based on photovoltaic power supply is designed for cathodic protection applications in remote and rough terrains [7]. The control circuit of the cathodic protection system regulated by solar energy has been designed [8]. Current source cathodic protection and cathodic protection techniques using anode were compared [9]. The effectiveness of the cathodic protection system was tested by analyzing the soil properties that affect the corrosion process of the steel when cathodic protection is applied or not [10]. Cathodic protection with hybrid energy photovoltaic and wind energy current source is outlined [11]. In this study, the use of solar energy in galvanic anode cathodic protection systems was investigated. The electric current needed for the protection of metal structures protected against corrosion was provided from solar panels. Thus, thanks to the energy supplied from the panels

throughout the day, the rapid loss of mass of the anodes was prevented and the life of the anodes was extended. In case such a system is installed, it has been investigated whether the number of anodes needed to protect the metal from corrosion can be reduced or the protection life of the anodes can be extended by keeping the number of anodes constant. In addition, efficiency analysis was made by comparing this system with standard systems.

## 2. Metal Corrosion

Corrosion of metals is an electrochemical process. This process; It is a circuit in which electric current occurs by displacing electrons due to chemical reactions in a part of the circuit. These chemical reactions affect the surface of the metal as an electrolyte. The oxidation reaction (corrosion) occurs on the anode surface, and the hydrogen output occurs on the cathode surface. Corrosion control systems are cathodic protection systems based on the displacement of oxidation reactions by artificially turning the protected structures into a cathode. Figure 1 shows a corroded metal.



Fig. 1. Metal corrosion

Electrochemical reactions are oxidation (oxidation) in the anode region and reduction (reduction) reactions in the cathode region, which occur from electron exchange [12]. During corrosion formation, electron accepting (cathodic)

and electron donating (anodic) reactions occur. In the oxidation reaction, the iron atom loses two electrons, these reactions occurring in the opposite direction are called reduction. The chemical reactions showing this situation are

as follows [12, 13]. Figure 2 shows the formation of electrochemical corrosion cells [14, 15].

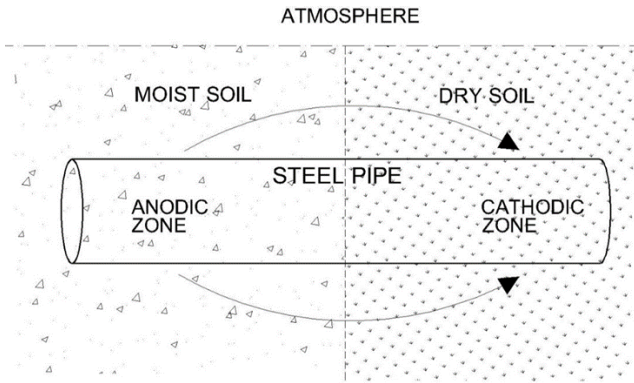
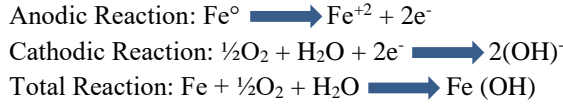

Fig. 2. Electrochemical corrosion cell formation in an underground pipeline

**2.1. Anode-Cathode and their relationship**

The anode is the most conspicuous part of the corrosion cell. This is a chemical reaction or oxidation reaction, which combines with the other element as a result of the loss of electrons from the metal. If this metal is steel, iron rust occurs in the material as a result of corrosion. The cathode is the part of the corrosion cell that is protected from corrosion. The chemical reaction here is an electron reduction reaction.

In an electrochemical corrosion cell, one electrode becomes either anode or cathode depending on the potential result with respect to the other electrode. This electrical potential difference is the potential difference between the anode and the cathode. The electrically more active or more negative electrode is designated as the anode, and the other electrode becomes the cathode. The cathode is the protected part that is not exposed to the oxidation reaction. The electrolyte is the third part of the corrosion cell. There is ion flow in this section. The electrolyte is a material that contacts both the anode and the cathode. Here there is ion flow to both the anode and the cathode. With the metallic connection, the electrical circuit of the corrosion cell is completed and electron flow is provided. This flow of electrons occurs when an electrochemical reaction occurs. In a tank or pipeline, the metallic connection is the tank or pipeline itself.

**2.2. Standard electrode potentials of metals**

The standard electrode potential is the potential of a metal measured in solution with an activity of 1 at 25°C. The electrode potential of a metal varies according to the type and concentration of ions in the solution. That is, the same metal has different electrode potential values in different solutions and these are shown in Table 1 [1, 2].

**Table 1.** Nernst standard electrode potentials of metals with scale

Metals	Ions	Potential Value (V)
Lithium	Li+	-3.03
Potassium	K+	-2.925
Sodium	Na+	-2.713
Magnesium	Mg++	-2.371
Aluminum	Al+++	-1.66
Zinc	Zn++	-0.7628
Chromium	Cr+++	-0.74
Iron	Fe++	-0.44
Nickel	Ni++	-0.23
Tin	Sn++	-0.14
Lead	Pb++	-0.126
Hydrogen	H+	0
Copper	Cu++	0.337
Silver	Ag++	0.7994
Platinum	Pt++	1.2
Gold	Au+++	1.46

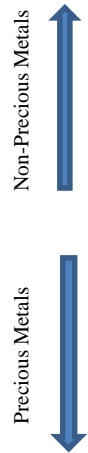

**2.3. Electrolysis**

The word electrolysis means analysis by electric current. Electrolysis occurs only when current is passed through the electrodes. The electrode connected to the positive pole of the direct current generator is called the anode. The electrode connected to the negative pole is called the cathode. A system consisting of a metal and its solution is called a half cell, if a second electrode is immersed in the solution and connected to each other, it is called an electrochemical cell. The corrosion cell can be thought of as a battery consisting of two electrodes, one anode and one cathode, immersed in the same electrolyte [16].

**3. Cathodic Protection**

Wrought metals corrode if they are in direct contact with soil or water. This problem has been tried to be overcome by making various coatings on the metal surface. The coatings were effective against corrosion to a certain extent. But small holes have always existed in these coatings. Water vapor, moisture, atmospheric gases or other gases pass through these micro holes and reach the surface of the coated metal. This event causes corrosion on the metal surface. Galvanic corrosion should be avoided in combinations where two different metals are used together. There should be sufficient potential difference between the metals or they should not come into direct contact with each other so that the galvanic factor does not occur [17].

Applications and repairs to metal after corrosion has occurred are very expensive. Among the corrosion protection methods, the most widely used method in the industry is cathodic protection. In order to prevent the flow of electrons from the anode to the cathode, protection occurs by supplying current to the cathode with an external source [18]. Corrosion



on bare or coated metals can be completely prevented with cathodic protection. In practice, they can be protected by cathodic protection against corrosion by metals such as steel, copper, brass, lead and aluminum, in all types of soils and in almost all stable environments.

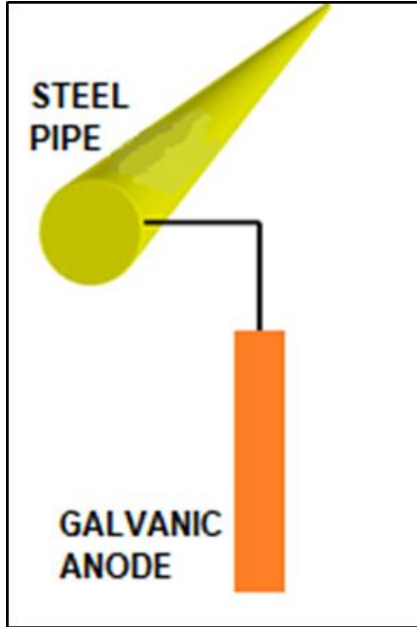

Fig. 3. Cathodic protection with galvanic anode

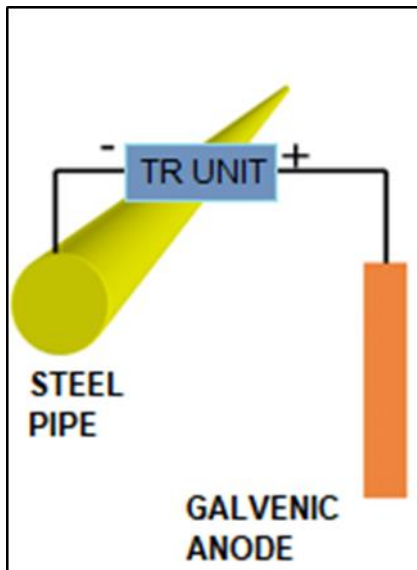

Fig. 4. Cathodic protection with external source

Cathodic protection is to corrode a metal by operating it as an anode and, in turn, to form a large corrosion cell that protects against corrosion by operating the structure or structures to be protected from corrosion as cathodes. Cathodic protection is carried out in two ways. The first method is cathodic protection with galvanic anode as seen in Figure 3. The other method is the external current sourced cathodic protection method, as seen in Figure 4. Galvanic protection is accomplished by applying an electric current to

the metal structure to be protected. External cathodic protection; the voltage applied to the metal is adjusted by means of a rectifier.

### 3.1. Galvanic anode cathodic protection

It is called cathodic protection with galvanic anode, when the metal to be protected is made into a more active metal anode than this metal compared to the galvanic series. In this type of cathodic protection, magnesium, aluminum, zinc and their alloys are used as galvanic anodes. This anode protection method is generally preferred because there is no electricity or the electricity transmission line cost is high. In addition, cathodic protection is used to protect metals with low current needs. However, it is not appropriate to use a galvanic anode protection system in areas with electrical specific resistance higher than 4000 ohm meter ( $\Omega$  m) [19].

The galvanic anode cathodic protection system is easier to design and implement than the external current source system. This protection does not require an external current source and a control system [20]. Galvanic anode cathodic protection is a simple and inexpensive method. This type of protection is usually applied to small metal structures or well-insulated metal materials. As seen in Figure 5, in this system, the standard potential is achieved by bonding with a more negative metal than the metal itself to be maintained. The metal that will be the anode works like a low voltage generating battery. In low voltage protection, some parts of the metal are prevented from being protected by excessive current.

Generally, magnesium and zinc anodes are used. Main uses:

- In small network pipelines or metal structures
- In sheath pipes used in special crossings (road, stream crossing, etc.).

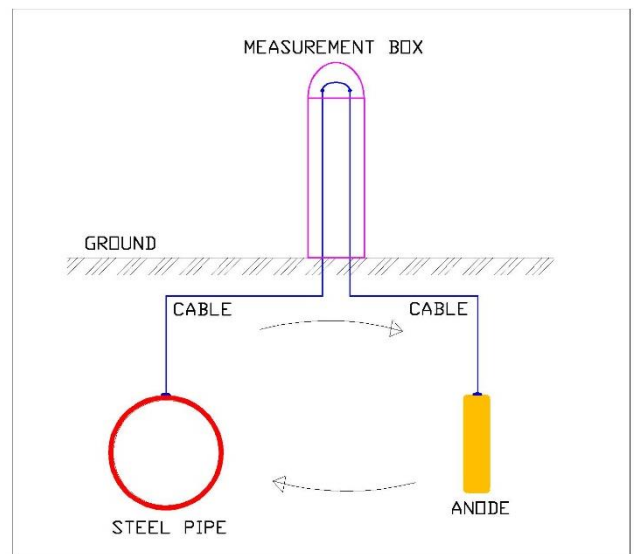

Fig. 5. Basic view of cathodic protection

**3.1.1. Anode life in galvanic anode cathodic protection system**

Cathodic protection current requirement is the current required to cathodically protect a metal with a surface size of 1 m<sup>2</sup>. Since this current will be supplied from the anode, some calculations can be made to calculate the dimensions of the anode, the approximate anode life and the number of anodes sufficient for protection. However, in practice, two important factors affecting the anode life need to be considered. One of them is the anode current efficiency. The anode current efficiency is defined as the ratio of the current drawn from the anode to the current calculated by Faraday's Law. There is also the anode usage factor. As the anodes are used, their surface area decreases along with the loss of mass. As a result, the anode resistance gradually increases. On the other hand, the consumption of the anode never proceeds uniformly and cannot be used until the anode mass is completely depleted. In practice, it is accepted that at most 85% of the galvanic anode mass can be used. The total current (I<sub>t</sub>) drawn from the anodes is calculated as in Equation 4. The resistance (R<sub>anode</sub>) in the environment where the anode is located is obtained as in Equation 1. Resistance (R<sub>anode</sub>) affects current drawn from anode [21].

$$R_{anot} = \frac{\rho}{(2 \pi L) [\ln(4L \div d) - 1]} \tag{1}$$

R<sub>anode</sub>: Anode resistance (Ω)

ρ: Soil specific resistance (Ω)

L: Anode length (cm)

d: Anode diameter (cm)

Anode current (I<sub>m</sub>) is obtained from the division of the anode-steel circuit voltage (ΔE) by the anode resistance (R<sub>anode</sub>) as in Equation 2.

$$I_m = \Delta E / R_{anode} \tag{2}$$

I<sub>m</sub>: Anode current (A)

ΔE: 0.75 Mg Anode–Steel circuit voltage,

The total surface area to be cathodically protected (S<sub>k</sub>) is calculated as in Equation 3. The surface area depends on the diameter and length of the steel pipe.

$$S_k = 2 \pi r L \tag{3}$$

S<sub>k</sub>: Total surface area to be protected (m<sup>2</sup>)

L : Pipe length (m)

r : Pipe radius (m)

A bare steel pipe has a protection current density value that varies with the soil resistivity. Table 2 shows the ranges of current density values according to the variable soil resistivity of steel pipes. In order to protect a polyethylene-coated pipe, the current density is reduced by 1/10 compared to the bare pipe.

**Table 2.** Current demand density of steel pipes [21]

Soil Type	Electrical Specific Resistance (ohm cm)	Current Demand Density (mA /m <sup>2</sup> )
Highly Corrosive	< 1000	20 < I <sub>k</sub>
Corrosive	1000-3000	20 > I <sub>k</sub> > 5
Medium Corrosive	3000-10000	5 > I <sub>k</sub> > 0.1
Less Corrosive	10000 <	I <sub>k</sub> < 0.1

I<sub>k</sub>: Current Demand Density

The total protection current (I<sub>t</sub>) to be drawn from the anode is obtained as in the Equation 4.

$$I_t = S_k I_k \tag{4}$$

I<sub>t</sub>: Total protection current (A)

The lifetime calculation of galvanic anodes is calculated as in Equation 5 [21]. By using this formula, it is found out how many years a metal structure can be protected by using anodes of a certain mass.

$$G_{ao} = \frac{Anode\ Mass(kg) \cdot Anode\ Efficiency \cdot Aging\ factor}{Current\ Drawn\ from\ Anode\ It(A) \cdot Theoretical\ Wear(\frac{kg}{A\ year})} \tag{5}$$

G<sub>ao</sub>: Galvanic Anode Life

Theoretical Wear: 4 (kg/A year) (for Mg anode)

Aging Factor: 0.85

Anode Efficiency: 0.5

As seen in Equation 5, the lifetime of the anodes used in cathodic protection depends on the current drawn from the anodes [21]. The current drawn from the anode depends on the type and mass of the cathodically protected structure, the ambient conditions of the metal and the anode (earth resistance and soil properties), whether the protected structure is insulated or not, and the type and thickness of the insulation. These conditions can be improved positively to extend the life of the anodes. In addition, with an additional current source to be connected to the cathodic protection system, the anode life can be extended by reducing the current drawn from the anodes. These current sources can also be the type of energy obtained from renewable energy sources.

**3.2. Extending anode life using solar energy**

Galvanic anodes are below a certain level in mass. they cannot supply the current required for the thought pipelines. For this reason, the aging factor, that is, the disposable mass ratio, is considered as 85% [22]. Renewable energy sources can be used to keep this current drawn from the anodes to a minimum and reduce mass loss.

In this study, a system is designed in such a way that the electrical current required by the metal pipeline is provided by the solar panel during the day and by the anodes in other time periods. Thus, as seen in Equation 5, since the current



drawn from the anodes will decrease, rapid depletion of the anodes will be prevented and their lifetime will be extended. The solar panel was selected according to the current requirement of the metal structure to be protected from corrosion and an electrical circuit was used to transfer the generated current to the metal structure. In addition to this electrical circuit, when the solar panel does not produce current, a system is designed as shown in Figure 6 to supply the current requirement of the metal structure from the anodes. The materials required for such a system are a 6 V 250 mA solar panel, a voltage control card and a titanium anode.

In the designed system, the cathodic protection of the 50 meter-long 10" (inch) bare steel pipeline with Mg anode is supported by the solar energy system. The resistance of the anodes ( $R_{anode}$ ) was calculated according to Equation 1. The anode current ( $I_m$ ) according to the anode resistance was obtained from Equation 2. The total surface area ( $S_k$ ) of the steel pipe to be cathodically protected was found as in Equation 3, and the total shielding current ( $I_t$ ) drawn from the anodes according to the total surface area was obtained from Equation 4. Finally, the lifetimes ( $G_{ao}$ ) of the galvanic anodes were calculated from Equation 5. The information required for the calculations was given in Table 3. In Table 4, the values obtained as a result of the calculations were given.

**Table 3.** Required data for calculations

Soil specific resistance ( $\rho$ )	4000ohms
Anode size (L)	65cm
Anode diameter (d)	9cm
Mg Anode-Steel circuit voltage ( $\Delta E$ )	0.75
Pipe length (L)	50m
Pipe radius (r)	136.5mm
Total surface area to be protected ( $S_k$ )	42.86 m <sup>2</sup>
Current demand density ( $I_k$ )	1.2 mA/m <sup>2</sup>
1pcs Mg Anode Mass	7.7kg
Theoretical Wear	4 (kg /A year) (For Mg anode)
Aging Factor	0.85
Anode Efficiency	0.5
Current Drawn from the Anode ( $I_t$ )	0.0543 A

**Table 4.** Calculation results

Anode resistance ( $R_{anode}$ )	14.5 ohm
Anode current ( $I_m$ )	51.7 mA
Total surface area to be protected ( $S_k$ )	42.86 m <sup>2</sup>
Total protection current to be drawn from the anodes ( $I_t$ )	51.43 mA
Anode Life ( $G_{ao}$ )	about 15 years

A current of 51.43 mA is needed to protect the steel pipe. Since the current drawn from one anode is 51.7 mA, one anode will be sufficient for cathodic protection. The galvanic anode life ( $G_{ao}$ ) in the cathodic protection to be made using 1 anode has been found to be approximately 15 years. In other words, a 50 meter 10" steel pipe can be protected for 15 years

with a single anode. The life of the anode will increase when the solar drying system designed with this anode is used. In İzmir province of Turkey, where the average sunshine duration is 8 hours, protection is provided by obtaining current from the sun in 1/3 of the day. In this operating condition, the pipe protection life of the anode is increased by approximately 50%. Therefore, with the designed system, steel pipes will be protected against corrosion for 22.5 years. The system designed using solar energy is as in Figure 6.

**Cost calculation:** According to Equation 5, the number of anodes should be increased by 1.5 times in order to extend the life of the anodes by 50%. One anode and installation cost are approximately \$ 200. For example, if a structure protected with 2 anodes is desired to be protected with 3 anodes, the cost \$200 more. On the other hand, when solar panels are used in the cathodic protection system made by using 2 anodes, the lifetime of the anodes increases by 50%. The installation cost of the system required for this is a maximum of \$100. This system saves about \$100 for each anode to be used. In other words, a system with 50% savings in terms of cost has been designed. The savings will be even greater when this proposed system is used in larger facilities.

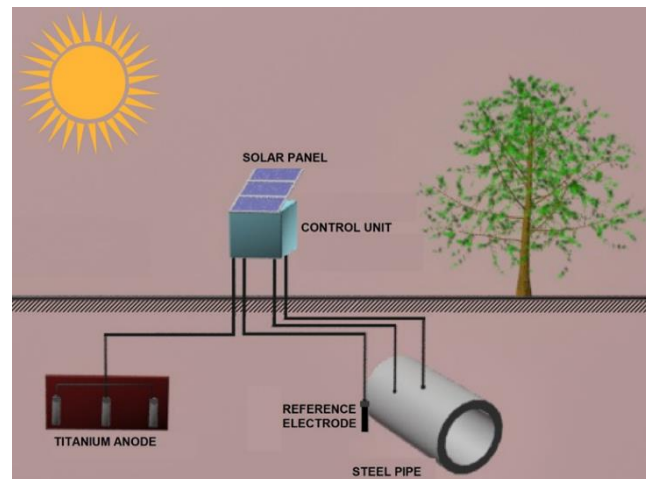

**Fig. 6.** Solar energy use in galvanic anode cathodic protection system

#### 4. Conclusion

Metals are subject to corrosion and metal loss when they are in any conductive medium. Unprotected metal structures are subject to corrosion, causing great material damage and loss of time. For this reason, all metal structures that may corrode should be protected from corrosion by taking them under protection. There are several methods to protect metal structures from corrosion. The cathodic protection method, which is one of the most important and most effective of these methods, is used today to prevent corrosion in many metal structures.

In the galvanic anode cathodic protection system, which is one of the various methods of cathodic protection, the



lifetime of the galvanic anodes used to protect the metallic structure from corrosion is an important parameter. Because during protection, the mass of the galvanic anodes is depleted and becomes dysfunctional. The longer the lifetime of the anodes can be extended, the longer the corrosion protection time of the metallic structure will be.

In order to protect a metallic system with cathodic protection with a galvanic anode from corrosion for a longer time and at low cost, the anode life should be extended. In order to extend the anode life in an anode protected system, either more anodes should be used or a system should be installed to reduce the current drawn from the anode. The cost of the system to be built with more anodes will increase approximately 2 times according to the size of the need.

In this study, the solar energy system, which is one of the renewable energy sources, was used to reduce the current drawn from the anode and to extend the life of the anode. The life of the anodes is extended by reducing the current drawn from the anode by using the solar panel. The current required for cathodic protection was obtained from the sun for about 8 hours during the daytime and the current drawn from the anode was stopped. During the night, the current drawn from the anodes provided the cathodic protection. In this system, which was designed by using a solar panel together with the anode, the lifetime of the galvanic anodes was increased by approximately 50%. It was determined that if the number of anodes were increased instead, the installation cost would increase by 50%. As a result, by using the proposed system, the installation cost of the system was reduced by 50% and the life of the system was extended by 50%.

Since the solar panel and electronic circuit costs are lower than the costs of burying the anode and anodes in the ground, the system will work more efficiently. The longer the life of the anodes, the greater the economic benefit. Cost and lifetime analysis of the system can be performed by using other renewable energy sources such as wind.

#### Authorship contribution statement for Contributor Roles Taxonomy

**Niyazi Karabacak:** Regarding the problem addressed in the article collection of data, appropriate solution to the data determination of methods and solution methods the writing process of the article with the application of has done.

**Abdulhakim Karakaya:** He contributed to the application of the methods used in the study and the interpretation of the results.

#### Conflict of interest

There is no conflict of interest in this study.

#### References

- [1] Erden, S., Değertekin, M.C. 2004. Corrosion and Cathodic Protection, Kocaeli EMO Branches, Kocaeli, Turkey.
- [2] Popov, B.N. Corrosion Engineering Principle and Solved Problems, 1st Edition, Elsevier ISBN 9780444627223, eBook, 2015.
- [3] NACE 2016. International Measures of Prevention Application and Economics of Corrosion Technologies Study Report, USA.
- [4] Odabaşı, T. 2005. External Current Source Cathodic Protection System in Pipelines Account, Botaş Publications.
- [5] Durham, M.O. 1987. Solar Powered Cathodic Protection Using Residual Potential, IEEE Transactions on Industry Applications, IA-23(3), 433 - 439.
- [6] Sai Shankar, B., Pranav K. P. and Kiran Raj R. 2014. Solar Powered Corrosion Prevention of Iron Pipelines Using Impressed current cathodic Protection, 14th International Conference on Environment and Electrical Engineering, 10-12 May, Krakow, Poland.
- [7] Mishra, P.R., Joshi, J.C. and Roy, B. 2000. Design of A Photovoltaic-Powered Mini Cathodic Protection System, Solar Energy Materials and Solar Cells, 61(4), 383-391.
- [8] Wagdy, R.A. 1995. Design of Control Circuit of Solar Photovoltaic Powered Regulated Cathodic Protection System, Solar Energy, 55(5), 363-366.
- [9] Bashi, S.M., Mailah, N.F. and Radzi, M.A.M. 2003. Cathodic Protection System, National Power Engineering Conference, 15-16 December, Bangi, Malaysia.
- [10] Mahlobo, M.G.R., Mjwana, P., Tladi, M.N.A., Obadele, B.A, Olubambi, P.A. and Refait P.H. 2018. Evaluation of Cathodic Protection Performance of Carbon Steel Pipeline Buried in Soil, IEEE 9th International Conference on Mechanical and Intelligent Manufacturing Technologies (ICMIMT), 10-13 February, Cape Town, South Africa.
- [11] Sibiyi, C.A, Kusakana, K. and Numbi, B.P. 2018. Smart System for Impressed Current Cathodic Protection Running on Hybrid Renewable Energy, IEEE Open Innovations Conference, 03-05 October, Johannesburg, South Africa.
- [12] Roberge, P.R. Handbook of Corrosion Engineering, Second Edition, The Mc-Graw-Hill Companies, USA, 2012.
- [13] Beckman, W.V., Schwenk, W. and Prinz, W. Handbook of Cathodic Corrosion Protection, Gulf Professional Publishing, USA, 1997.



- [14] Davis, J.R. Corrosion: Understanding the Basics, ASM International, USA, 2000.
- [15] Gerengi, H. 2013. The Chemical and Electrochemical Formation Mechanism of Corrosion, Düzce University, Corrosion Research Laboratory, Düzce.
- [16] Anonymous, Renewable Energy Sources, MMO, Publication No: E/2001/275, Kayseri, 2001.
- [17] Kaftan, M.A. 2006. Cost Comparison of Corrosion Formation and Corrosion Protection Methods in Steel Structures, Master Thesis, Pamukkale University, Institute of Science and Technology, Denizli, Turkey.
- [18] Revie, R.W., Uhlig, H.H. Corrosion and Corrosion Control: An Introduction to Corrosion Science and Engineering, 4th ed., A John Wiley & Sons Inc., Hoboken New Jersey, 2008.
- [19] Metin, E. 2007. Cathodic Protection Systems New Applications and Economic Analysis, Master Thesis, Yıldız Technical University, Institute of Science and Technology, Istanbul, Turkey.
- [20] Nadzri, N.I. and Amin, N.M. 2019. A Review of Cathodic Protection In Repairing Reinforced Concrete Structures, *Journal of Mechanical Engineering*,16(2), 183-198.
- [21] TSE, 2019. Cathodic Protection General Principles and Practice for Buried or Submerged Metallic Structures and Pipelines”, TS 5141 EN 12954.
- [22] Yalçın, H. and Koç, T. Cathodic Protection, Palme Publications, First Edition, Ankara,1999.

