



POLİTEKNİK DERGİSİ

JOURNAL of POLYTECHNIC

ISSN: 1302-0900 (PRINT), ISSN: 2147-9429 (ONLINE)

URL: <http://dergipark.org.tr/politeknik>



Investigation and efficiency analysis of dual-boost bridgeless PFC converter

Dual-boost köprüsüz PFC dönüştürücünün incelenmesi ve verimlilik analizi

Yazar(lar) (Author(s)): Aybüke ERTÜRK¹, Ramazan AKKAYA²

ORCID¹: 0000-0001-8282-1934

ORCID²: 0000-0002-6314-1500

To cite to this article: Ertürk A., Akkaya R., “Investigation and Efficiency Analysis of Dual-Boost Bridgeless PFC Converter”, *Journal of Polytechnic*, 28(1): 115-122, (2025).

Bu makaleye şu şekilde atıfta bulunabilirsiniz: Ertürk A., Akkaya R., “Investigation and Efficiency Analysis of Dual-Boost Bridgeless PFC Converter”, *Journal of Polytechnic*, 28(1): 115-122, (2025).

Erişim linki (To link to this article): <http://dergipark.org.tr/politeknik/archive>

DOI: 10.2339/politeknik.1381658

Investigation and Efficiency Analysis of Dual-Boost Bridgeless PFC Converter

Highlights

- ❖ The positive and negative aspects of the Dual-Boost Bridgeless PFC (D-BBPFC) Converter are examined.
- ❖ Simulation results of D-BBPFC are compared with Conventional Boost PFC (CBPFC) Converter.
- ❖ At different power levels, the change of power factor and harmonics is presented in graphic form.
- ❖ The converters are rerun by using MOSFETs which have different ON-resistances.

Graphical Abstract

By performing a simulation study of Dual-Boost Bridgeless PFC Converters, the power factor, total harmonic distortion of the input current ($I_{in(THD)}$) and efficiency are examined. The change of power factor and total harmonic distortion at different load situations is presented graphically. CBPFC and D-BBPFC converters are re-operated using MOSFETs with different ON-resistances and detailed efficiency analysis is performed.

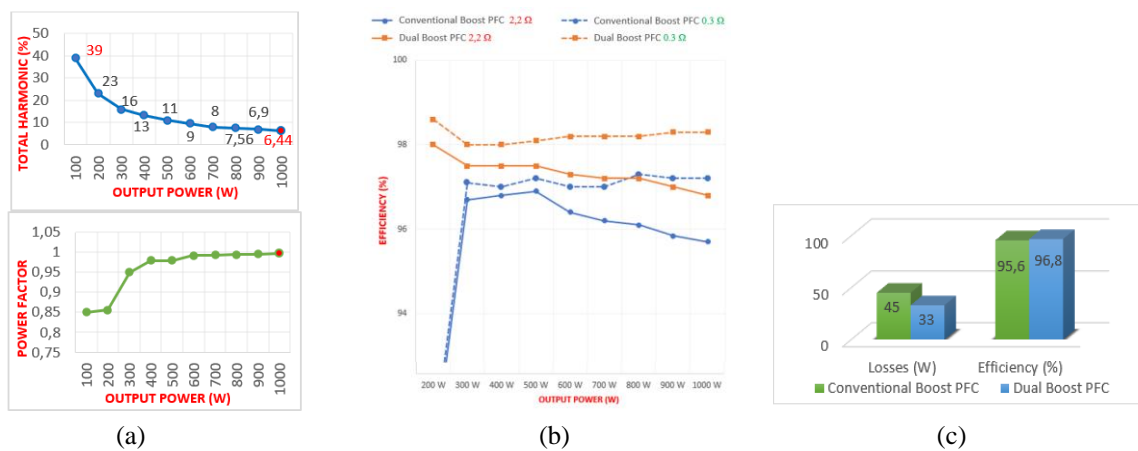

Figure. a) The change of power factor and harmonic distortion b) detailed efficiency analysis c) comparison of losses and efficiency of converters

Aim

Investigation of Dual-Boost Bridgeless PFC Converters, which offer solutions to power quality problems with high efficiency advantages for high-power applications.

Design & Methodology

The converters are simulated in the PSIM environment by controlling them with the Average Current Control Method and operating them in Continuous Conduction Mode (CCM).

Originality

Thanks to SiC and GaN MOSFETs, which are thought to replace existing MOSFETs in the near future, it is predicted that the limiting effect of the ON-resistance of the switch will decrease.

Findings

The power factor value of the D-BBPFC is measured as 0,997, its harmonic distortion is 6,44 % and its efficiency is 96,8 %.

Conclusion

It is seen that Dual-Boost Bridgeless PFC Converters provide solutions to power quality problems with higher efficiency. Additionally, the importance of MOSFET's used in converters has been proven.

Declaration of Ethical Standards

“The authors of this article declare that the materials and methods used in this study do not require ethical committee permission and/or legal-special permission.”

Investigation and Efficiency Analysis of Dual-Boost Bridgeless PFC Converter

Araştırma Makalesi / Research Article

Aybüke ERTÜRK ^{1*}, Ramazan AKKAYA ²

^{1,2} Konya Technical University, Faculty of Engineering and Natural Sciences, Konya, Turkey

(Geliş/Received : 26.10.2023 ; Kabul/Accepted : 05.01.2024 ; Erken Görünüm/Early View :03.06.2024)

ABSTRACT

The increase in electricity consumption makes the electrical efficiency of the systems more important day by day. This situation necessitated the search for high efficiency in Power Factor Correction (PFC) converters, which offer solutions to power quality problems caused by rectifiers. In this study, Bridgeless Boost PFC Converters with high efficiency advantage are examined. The advantages and disadvantages of these converters are presented. Dual-Boost Bridgeless PFC Converter (D-BBPFC), which is a type of bridgeless converters, is introduced and the converter is simulated in the PSIM environment. The obtained total harmonic distortion of input current ($I_{in(THD)}$), power factor and efficiency values are compared with the Conventional Boost PFC Converter (CBPFC), which is designed in our previous studies with the same parameters. By operating the Dual-Boost Bridgeless PFC Converter at different power levels, the change of power factor and total harmonic distortion is presented in graphic form. For a more detailed efficiency analysis, the converters are rerun by using MOSFETs which have different ON-resistances. As a result, the efficiency advantage of Bridgeless Boost PFC Converters is proven. In addition, in light of the results obtained, it is clear that THD and PFC values can be further improved, as well as increased efficiency, by using MOSFETs with low ON resistance, such as SiC and GaN, by implementing the same converters, especially at higher power and frequency values.

Keywords: Power factor correction, harmonic distortions, efficiency, SiC-GaN MOSFET's

Dual-Boost Köprüsüz PFC Dönüştürücünün İncelenmesi ve Verimlilik Analizi

ÖZ

Artan enerji tüketimi ile birlikte elektrik sistemlerinde verimlilik günden güne daha da önemli hale gelmektedir. Bu durum doğrultuculardan kaynaklanan güç kalitesi sorunlarına çözüm sunan Güç Faktörü Düzeltmeli dönüştürücülerde yüksek verim arayışını zorunlu kılmıştır. Bu çalışmada yüksek verim sunan Köprüsüz Boost PFC (Power Factor Correction (Güç Faktörü Düzeltme)) Dönüştürücüler incelenmiştir. Bu dönüştürücülerin olumlu ve olumsuz özellikleri sunulmuştur. Köprüsüz dönüştürücülerin bir türü olan Dual-Boost Köprüsüz PFC Dönüştürücü tanıtılmış ve dönüştürücünün PSIM ortamında simülasyonu yapılmıştır. Elde edilen giriş akımı harmonik içeriği, güç faktörü ve verimlilik değerleri, daha önceki çalışmalarımızda aynı parametrelerle tasarlanan Klasik Boost PFC Dönüştürücü ile karşılaştırılmıştır. Dual-Boost Köprüsüz PFC Dönüştürücü farklı güç seviyelerinde çalıştırılarak güç faktörünün ve toplam harmonik bozulmanın değişimi grafiksel olarak sunulmuştur. Daha detaylı bir verim analizi için dönüştürücüler farklı iletim dirençlerine sahip MOSFET'ler kullanılarak tekrar çalıştırılmıştır. Sonuç olarak Köprüsüz PFC Dönüştürücülerin verimlilik avantajı kanıtlanmıştır. Ayrıca elde edilen sonuçlar ışığında, SiC ve GaN gibi ON direnci düşük olan MOSFET'lerin kullanılmasıyla, aynı dönüştürücülerin özellikle daha yüksek güç ve frekans değerlerinde gerçekleştirilmesi ile verim artışının yanında THD ve PFC değerlerinin daha da iyileştirilebileceği açıktır.

Anahtar Kelimeler: Güç faktörü düzeltme, harmonik bozulmalar, verimlilik, SiC- GaN MOSFET'le

1. INTRODUCTION

AC-DC converters are used extensively in many fields from electronic devices to industrial and commercial devices such as electric vehicle battery charging systems [1]. The capacitor, which is used as a voltage filtering element at the converter output, is charged and quickly discharged only when the grid voltage is at its maximum. For this reason, it draws non-sinusoidal current from the AC source and causes low power factor [2],[3]. There are

different Power Factor Correction rectifiers to solve these problems [4],[5]. The basis of PFC rectifier circuits is CBPFC Converter, shown in Figure 1. In this circuit, there are a bridge rectifier and a boost converter added behind this rectifier [6]. Thanks to the switch operated at high frequency, the sinusoidal current is drawn in approximately the same phase with the AC source, and power factor is approached to '1' [7].

*Corresponding Author

e-posta : aozdenturk@ktun.edu.tr

In order to understand the working principles and waveforms of PFC converters and to be a criterion for evaluating Bridgeless Boost PFC Converters, CBPFC Converter is simulated at 400 V reference output voltage and 1 kW output power. Various waveforms obtained from the simulation, namely V_{in} (input voltage), I_{in} (input current), V_o (output voltage), and I_o (output current), are shown in Figure 2.a. The current values have been enlarged 10 times to make the waveforms more understandable. As seen in Figure 2.a, the I_{in} is sinusoidal and approximately in same phase with the V_{in} . In steady state operation, for 220 V input voltage, the V_o is 400 V, the I_{in} is 4.76 A, and the output current is 2.5 A, as intended. In Figure 2.b, the $I_{in(THD)}$, and in Figure 2.c, the power factor value is calculated in the simulation environment. The $I_{in(THD)}$ is 3.26% and the power factor value is 0.998 [8], [9].

According to the simulation results, Conventional Boost PFC Converter meets IEC 61000-3-2 standards in terms of power factor and harmonics [10],[11],[12]. The efficiency of the converter for the fully loaded condition is calculated as 95.6% by measuring the output power as 1000 W and the input power as 1045 W. Although this value seems sufficient, a more efficient converters would be more suitable especially at high power applications.

For this purpose, Bridgeless Boost PFC Converters are an important subject of study. Bridgeless PFC circuit topologies are used to increase the efficiency of PFC rectifiers. Unlike CBPFC Converters, these converters do not have a bridge rectifier. [13]. This topology can be basically classified as, Dual-Boost Bridgeless, Bridgeless Interleaved Boost, Semi-Bridgeless Boost and Phase Shifted Bridgeless Boost PFC converters” [14]. Figure 3 shows the basic Bridgeless Boost PFC Converter structure. While a single L inductor can be used on the input side, two separate inductors, L1 and L2, can also be used [15].

The use of two inductors offers better thermal performance [16]. Losses in a PFC converter can basically be classified as switching and conduction losses. Gate-drive losses and the inductor’s core loss can also be included in the switching losses. In fixed switching frequency operation, efficiency is dependent on switching losses for low power levels, whereas conduction losses become more significant at high power levels. In the Conventional Boost PFC Converter, three semiconductor elements are conducting, two diodes of bridge rectifier and a switch or a boost diode depending on the gate signal of switch, in each half-period of the source [17].

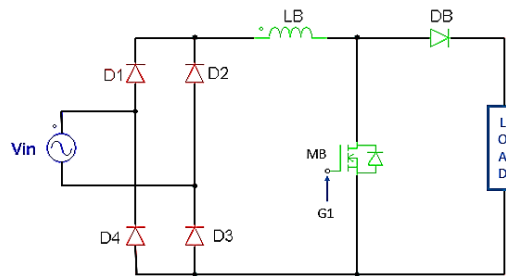
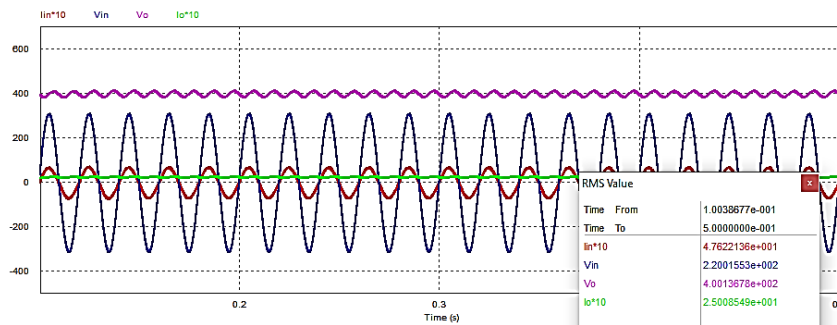
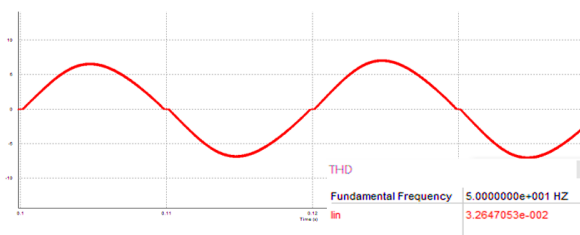

Figure 1. Circuit of the CBPFC Converter



(a)



(b)

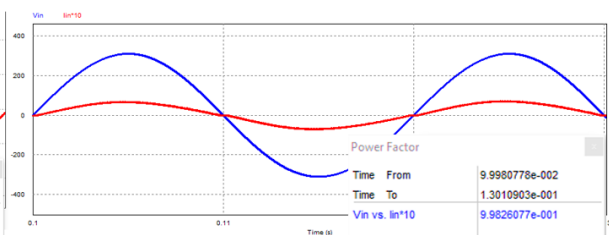

(c)

Figure 2. a) Waveforms b) $I_{in(THD)}$ c) power factor value of CBPFC Converter

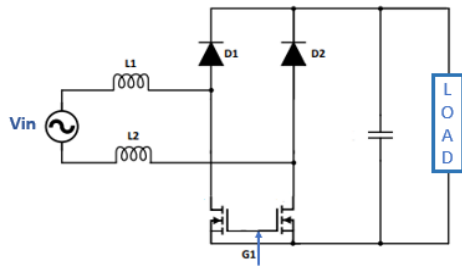

Figure 3. Circuit of Basic Bridgeless Boost PFC

However, in Bridgeless Boost PFC Converters, two elements, a diode or semiconductor switch and an internal diode of switch, are in conduction in each half-period depending on the gate signal of switch [18]. In this way, the conduction losses of the converter are significantly reduced and bridgeless converters are preferred for high power applications. In addition, diodes of bridge rectifier in Conventional Boost PFC Converter have high reverse recovery time. So switching losses are high in these diodes [19].

In the bridgeless converter, one of the rectifier diodes is taken over by the very fast internal diode of the MOSFET switch. In this way, the switching losses of the diodes are also somewhat reduced. Bridgeless Boost PFC Converter's major disadvantage is that they have higher CM (Common Mode) noise than CBPFC Converter. In CBPFC, the load ground is always connected to the supply via diodes of bridge rectifier. However, in Bridgeless Boost PFC, due to two inductors connected to the source, the potential of the output ground vibrates at high frequency (HF) at half the amplitude of the load voltage [20]. This HF pulsating source charges and discharges the parasitic capacitance between load ground and supply [21]. As a result, CM noise increases significantly. The result is that larger EMI filters must be used, which increases cost and reduces power density. In order to prevent this situation, there are studies in which C_3 and C_4 capacitors are added to limit the voltage variation between the output ground and the supply as seen in Figure 4.a, or a separate return path is provided with D3 and D4 diodes as in Figure 4.b [22].

Another disadvantage of Bridgeless Boost PFC Converters is that they require a frequency transformer or an optical coupler to measure the input voltage. Because of the current doesn't flow on the same ground in every half period, the measurement of the input current is also quite complicated [23]. In this context, the purpose of this study can be listed as follows:

- Examination of Dual-Boost Bridgeless PFC converters used to achieve higher efficiency than Conventional Boost PFC Converters.
- Monitoring the change of D-BBPFC Converter's power factor and harmonics for different load situations.
- Examining the effect of the MOSFETs by re-run the converters using MOSFETs with different ON resistors.

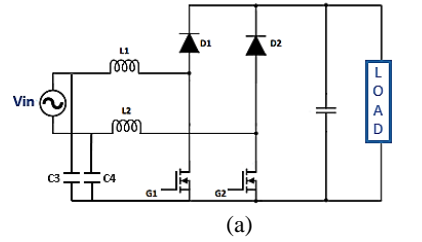

(a)

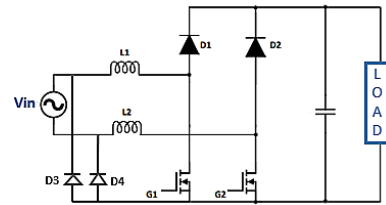

(b)

Figure 4. Solutions a) with two capacitors b) with two diode

2. MATERIAL AND METHOD

2.1. Dual-Boost Bridgeless PFC Converter

In Figure 5, the D-BBPFC Converter is given. Unlike the basic Bridgeless Boost PFC Converter that is given in Figure 3, S_1 - S_2 switches are controlled by independent signals. Switch S_1 is operated only in the positive half period of the AC source, while S_2 is operated only in the negative half period [24]. In this way, switching losses and at light loads conduction losses are further reduced [14]. The converter works like two boost converters working together.

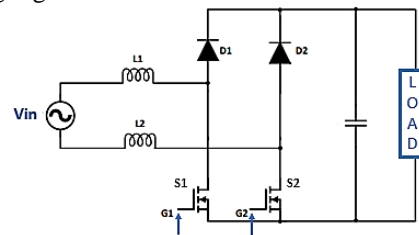

Figure 5. Circuit of the D-BBPFC Converter

Figure 6 shows, how D-BBPFC Converter work for positive and negative half period. In Figure 6.a, switch M_1 is ON in the positive half-period. I_{in} flows through M_1 , completes its circuit through the internal diode of switch M_2 . Diode D_1 is in passive position because it is reverse polarized and the output capacitor feeds the load. In Figure 6.b, M_1 switch is OFF and the input current flows through the D_1 diode, which is conducting because it is correctly polarized. The input current flows via the internal diode of switch M_2 . As can be seen from Figure 6.c-d, the same operation occurs with the M_2 , D_2 and internal diode of the switch M_1 , in the negative half period [25].

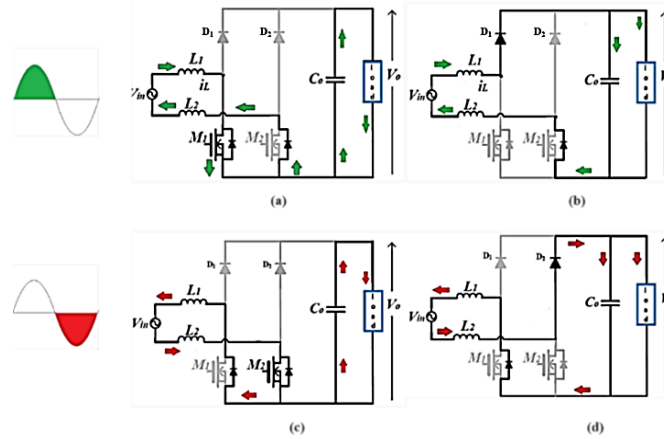

Figure 6. a) M_1 is ON b) M_1 is OFF in positive half-period c) M_2 is ON d) M_2 is OFF in negative half-period

In Figure 7, simulation model of D-BBPFC Converter prepared in PSIM program is given. In Table 1, the converter’s parameters used in the simulation are given. These values have been chosen equal to the parameters of the Conventional Boost PFC Converter, the results of which are given in Figure 2, in order to make a correct comparison. In Table 2, the converter’s elements used in

the simulation and their quantities are given. For more realistic results the datasheet values of the elements are used exactly. The D-BBPFC Converter is operated in Continuous Conduction Mode (CCM). It is controlled using the Average Current Mode Control Technique as CBPFC Converter [26].

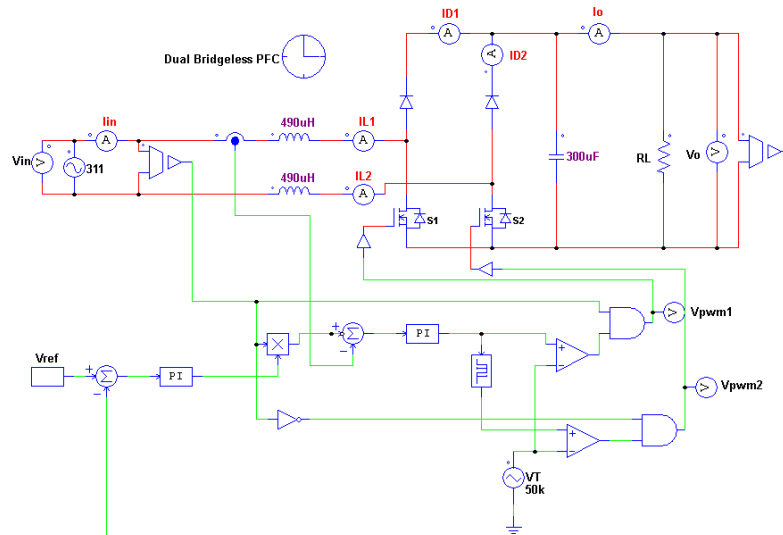

Figure 7. Simulation model of D-BBPFC Converter

Table 1. Parameters used in the simulation

P_o	1 kW
$V_{in(rms)}$	85-265 V
V_o	400 V
f_{sw}	50 kHz

Table 2. Elements used in the simulation and their quantities

	Conventional Boost PFC		Dual Boost PFC	
Regular diode	SF56G	*4	SF56G	*2
Fast diode	DSS17-06CR	*1	DSS17-06CR	*0
MOSFET	IRFBC30PBF	*1	IRFBC30PBF	*2
Inductor	490 uH	*1	490 uH	*2
Capacitor	300 uF	*1	300 uF	*1

The control signals applied to switches are seen in Figure 8. As seen in the figure, only in the positive half cycle of the source control signals are produced for S_1 , while the control signals of the S_2 are produced only in the negative half cycle.

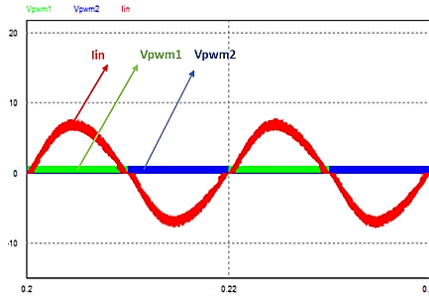
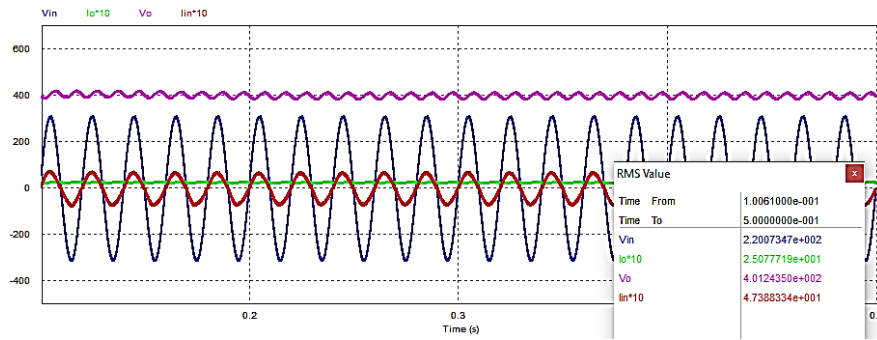

Figure 8. I_{in} and control signals of S_1 - S_2

The waveforms obtained from simulation studies are shown in Figure 9.a. As can be seen, the I_{in} is sinusoidal and follows the V_{in} as in the Conventional Boost PFC Converter. In steady state operation, the I_{in} is 4,738 A, the V_o is 401 V, and the I_o is 2,5 A for 220 V input voltage. In Figure 9.b, the $I_{in(THD)}$, and in Figure 9.c, the power factor value are shown. The $I_{in(THD)}$ is measured as 6,44% and the PF value is 0,997.

3. RESULT AND DISCUSSION



(a)

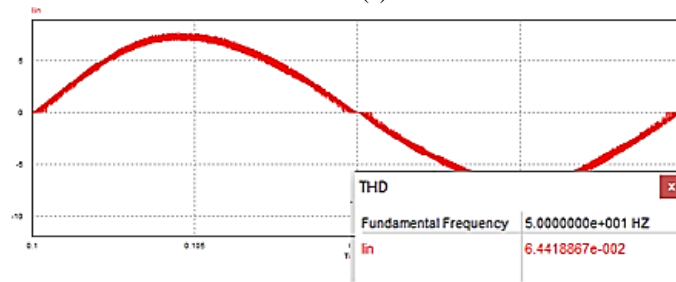

(b)

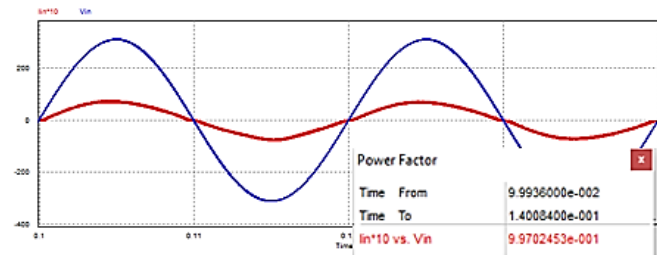

(c)

Figure 9. a) Waveforms b) $I_{in(THD)}$ c) power factor value of D-BBPFC Converter

For cases where D-BBPFC Converter is loaded in the range of 10%-100%, $I_{in(THD)}$ is given in Figure 10.a and in Figure 10.b power factor variation graphs are given. As can be seen from the graphs, as output power of the converter increases, the THD decreases, while the power factor value approaches '1'. When the converter is loaded at 10%, THD is measured as 39%, while at full load, the THD value drops to 6,44%. The best results are obtained in the fully loaded condition.

The output power of the converter is 1006 W and input power is 1039 W for the fully loaded condition. In this case, the efficiency is calculated as 96,8 %. In Figure 11, total losses and efficiency of CBPFC Converter and D-BBPFC Converter are given in graphic form for fully loaded condition.

When the graph is examined, it is seen that the efficiency of the D-BBPFC Converter is 1.2% higher. However, the improvement of efficiency is mainly related to the ON-resistance of the switches.

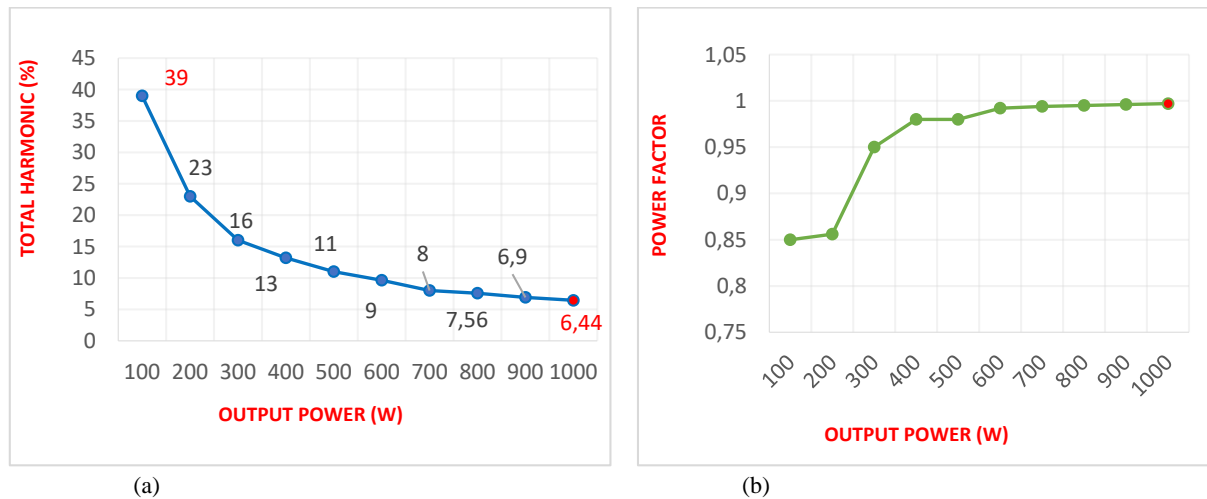

Figure 10. a) THD b) power factor of Dual-Boost Bridgeless PFC at 10%-100% output power

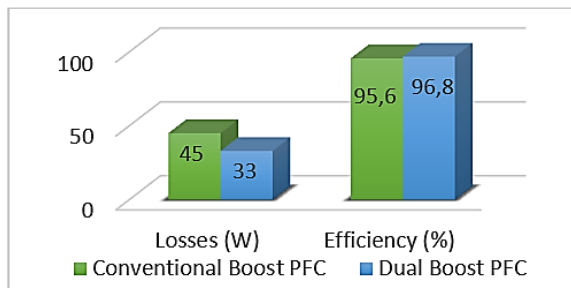

Figure 11. Losses and efficiency at fully load

To see effect of ON-resistance, IRFBC30PBF MOSFETs which have 2.2Ω ON-resistance used in CBPFC and D-BBPFC converters are replaced with IXKP13N60C5M MOSFETs which have 0.3Ω ON-resistance. In Figure 12, efficiency graphs of converters operated at different load states using MOSFETs with high and low conduction resistance are given. In both PFC rectifiers, converters using IXKP13N60C5M (0.3Ω) MOSFET provided higher efficiency in all power states compared to converters using IRFBC30PBF (2.2Ω). As the power value increases, it is seen that the efficiency of the converters with IRFBC30PBF (2.2Ω) decreases. This is because conduction losses become more significant at higher powers. There is no decrease in efficiency in the two types of converters using MOSFETs with low ON-

resistance. Even, efficiency increases because effect of switching losses reduce. In the 800-1000 W range, the Conventional Boost PFC converter using switches which have low ON-resistance provide higher efficiency than the Dual-Boost Bridgeless PFC Converter using switches which have high ON-resistance. This shows the importance of ON-resistors of switches in the efficiency of bridgeless converters. For this reason, Gallium Nitride (GaN) and Silicon Carbide (SiC) MOSFETs which have very low conduction resistance are very suitable for such converters and further increase the efficiency of the bridgeless converter. However, the higher cost of these semiconductors compared to classical semiconductors negatively affects the converters. The majority of the increased converter's cost consists of cost of semiconductors and cost of drivers. According to the price information obtained from the Future Electronics website, for the same voltage and current, the price of Si MOSFET is 2.05 \$, while the price of SiC MOSFET is 5.01 \$. In other words, the price difference of semiconductors is more than double. MOSFET drivers affect the price difference of converters more because SiC MOSFET drivers need a special driving scheme [27]. However, thanks to the developing semiconductor technology in recent years, the price difference has decreased and it is thought that this difference will decrease further in the coming years [28].



Figure 12. Efficiency graph of Conventional Boost and Dual-Boost Bridgeless PFC converters operated with different switches

4. CONCLUSION

PFC circuits are very important for correcting the disturbance effects caused by AC-DC converters on the source side. Dual-Boost Bridgeless PFC Converters, on the other hand, are used extensively in high power applications thanks to their high efficiency for power factor correction. In this study, the simulation results of the D-BBPFC Converter are compared with the results of the CBPFC Converter in various aspects. The D-BBPFC Converter offers almost equal and ideal results with the CBPFC Converter in terms of power factor. When the $I_{in(THD)}$ of the Dual-Boost Bridgeless PFC converter is examined, higher values are observed compared to the CBPFC converters. This requires larger sized filtering elements, increasing cost and volume, and is a negative feature for D-BBPFC converters. It is seen that the D-BBPFC Converter increases the efficiency by about 1% in the full load condition, when the two converters are compared in terms of efficiency. This result indicates that Dual-Boost Bridgeless PFC Converters are more suitable for high power applications. However, the ON-resistances of semiconductor switches used in bridgeless converters have a limiting effect on efficiency. For this reason, the conduction resistance of switches should be considered when designing the converter. Thanks to SiC and GaN MOSFETs, which are thought to replace existing MOSFETs in the near future, it is predicted that

the limiting effect of the ON-resistance of the switch will decrease.

DECLARATION OF ETHICAL STANDARDS

“The authors of this article declare that the materials and methods used in this study do not require ethical committee permission and/or legal-special permission.”

AUTHORS' CONTRIBUTIONS

Aybüke ERTÜRK: Theoretical research, simulation study and interpretation of results

Ramazan AKKAYA: Theoretical research and interpretation of results

CONFLICT OF INTEREST

There is no conflict of interest in this study.

REFERENCES

- [1] Pan L., Zhang C., “An integrated multifunctional bidirectional AC/DC and DC/DC converter for electric vehicles applications”, *Energies*, 9(7): 493, (2016).
- [2] Akkaya R., Gürbüz Y., “Design, Implementation and Comparison of Flyback Type Power LED Drivers with External and Internal PFC in Terms of Harmonics and Power Factor”, *International Journal of Advanced Research in Electrical, Electronics and Instrumentation Engineering*, 13493-13505, (2014).
- [3] Kabalcı E., Taşdemir O., “Mikro şebekelerde güç kalitesinin iyileştirilmesi için D-STATCOM tasarımı ve analizi” *Politeknik Dergisi*, 24(2), 361-372, (2021).

- [4] Şahin E., Büyükkatırcı O., Akın B., "AC-DC Dönüştürücü Tabanlı Güç Faktörü Düzeltme Devresi Tasarımı ve Uygulaması", *ELECO Electrical-Electronics-Computer and Biomedical Engineering Symposium*, 243-249, (2014).
- [5] Habib S., Khan M. M., Abbas F., Tang H., "Assessment of electric vehicles concerning impacts, charging infrastructure with unidirectional and bidirectional chargers, and power flow comparisons" *International Journal of Energy Research*, 42(11): 3416-3441, (2018).
- [6] Akın B., "Elektrikli Arabalarda Kullanılan Li-ion Akülerin Tek Fazdan Hızlı ve Verimli Şarjı için Güç Faktörü Düzeltmeli Yükselticilerin Karşılaştırması", *EMO Bilimsel Dergi*, 2(4), 87-93, (2012).
- [7] Kürker F., Taştın R., "Elektrik Tesislerinde Harmoniklerin Meydana Getirdiği Kayıpların Analizi", *Adıyaman University Journal of Engineering Sciences*, 5:1-38, (2016)
- [8] Özdentürk A., "Elektrikli Araç Şarj Cihazlarında Kullanılan Tek Fazlı Aktif Doğrultucuların Şebekeye Etkilerinin Karşılaştırılması", *Master's Thesis*, Konya Technical University-Institute of Science and Technology, (2021).
- [9] Ertürk A., Akkaya R., "Köprüsüz Boost PFC Dönüştürücünün Simülasyon Ortamında Performans Değerlendirmesi", *ELECO*, (2022).
- [10] Park G., Kee-Yong K., Tae-Woong K., "PFC dual boost converter based on input voltage estimation for DC inverter air conditioner." *Journal of Power Electronics*, 10.3 293-299, (2010).
- [11] 61000-3-2, "2004IEC", IEEE, International Electro technical Commission Geneva, Switzerland, (1998).
- [12] Karasu S., Saraç Z., "Güç kalitesi bozulmalarının hibert-huang dönüşümü, genetik algoritma ve yapay zeka/makine öğrenmesi yöntemleri ile sınıflandırılması" *Politeknik Dergisi*, 1219-1229, (2020).
- [13] Obdan A. H., Çınar A.O., "Güç Kaynakları İçin Yüksek Verimli Güç Faktörü Düzeltme Devresi Tasarımı" *Gazi Üniversitesi Fen Bilimleri Dergisi* 5(4): 187-99, (2017).
- [14] Praneeth A. V. J. S., Sheldon S. W., "A review of front end AC-DC topologies in universal battery charger for electric transportation", *IEEE transportation electrification conference and expo (ITEC)*, (2018).
- [15] Ye H., "Common mode noise modeling and analysis of dual boost PFC circuit", *INTELEC. 26th Annual International Telecommunications Energy Conference.*, (2004).
- [16] Huber L., Jang Y., Jovanovic M. M., "Performance evaluation of bridgeless PFC boost rectifiers", *IEEE Transactions on Power Electronics*, 23(3), 1381-1390, (2008).
- [17] Moriconi U., "A Bridgeless PFC Configuration Based on L4981 PFC Controller", *Application Note (AN)*, 1606, 18-18, (2002).
- [18] XueChao L., ZhiHao W., "UCC28070 Implement Bridgeless Power Factor Correction (PFC) Pre-Regulator Design", *Texas Instruments*, (2009).
- [19] Çavdar M., "Tek Fazlı Güç Faktörü Düzeltmeli (PFC) Köprüsüz AC-DC Dönüştürücülerin İncelenmesi ve Karşılaştırılması", *Master's Thesis*, Yıldız Technical University-Institute of Science and Technolog, 18-21, (2017).
- [20] Kong P., Shuo W., Fred C. L., "Common mode EMI noise suppression in bridgeless boost PFC converter.", *APEC 07-Twenty-Second Annual IEEE Applied Power Electronics Conference and Exposition.*, (2007).
- [21] Gopinath M., Ramareddy S., "A brief analysis on bridgeless boost PFC converter.", *International Conference on Sustainable Energy and Intelligent Systems (SEISCON 2011)*, 242-246, (2011).
- [22] Kong P., Shuo W., Fred C. L., "Common mode EMI noise suppression for bridgeless PFC converters", *IEEE Transactions on Power Electronics*, 23.1- 291-297, (2008).
- [23] Musavi F., Edington M., Eberle W., Dunford W. G., "Evaluation and efficiency comparison of front end AC-DC plug-in hybrid charger topologies." *IEEE Transactions on Smart grid*, 3.1 413-421, (2011).
- [24] Qi T., Xing L., Sun J., "Dual-boost single-phase PFC input current control based on output current sensing.", *IEEE Transactions on Power Electronics*, 24.11,2523-2530 (2009).
- [25] Enjeti P. N., Martinez R., "A high performance single phase AC to DC rectifier with input power factor correction", *Proceedings Eighth Annual Applied Power Electronics Conference and Exposition*, 190-195, (1993).
- [26] Erel M. Z., "Tek Fazlı Şebekeye Bağlı Evirici Tasarımı ve Kontrolü" *Journal of Polytechnic*, 25(3), (2022).
- [27] Nielsen R. Ø., Török L., Munk-Nielsen S., Blaabjerg F., "Efficiency and cost comparison of Si IGBT and SiC JFET isolated DC/DC converters." *In IECON 2013-39th Annual Conference of the IEEE Industrial Electronics Society* 695-699, (2013).
- [28] Stevanovic L.D., "Recent advances in silicon carbide MOSFET power devices", *Applied Power Electronics Conference and Exposition (APEC), Twenty-Fifth Annual IEEE*, 401-407, (2010).