

Research Article

# Speed Control of a Single-Phase Induction Motor Using a Fuzzy Logic Based Hysteresis Band PWM

Ece Yilmaz<sup>1\*</sup>, Sencer Unal<sup>2</sup>, Mehmet Ozdemir<sup>3</sup><sup>1</sup>Firat University, Electrical and Electronics Engineering Department, Elazığ, Turkey. (21113112@firat.edu.tr).<sup>2</sup>Firat University, Electrical and Electronics Engineering Department, Elazığ, Turkey. (sencerunal@firat.edu.tr).<sup>3</sup>Firat University, Electrical and Electronics Engineering Department, Elazığ, Turkey. (mozdemir@firat.edu.tr).

## ARTICLE INFO

Received: Mar., 14. 2024

Revised: July, 30. 2024

Accepted: Aug., 15. 2024

## Keywords:

Single Phase Induction Motor  
Hysteresis Band PWM  
Fuzzy Logic

Corresponding author: Ece Yilmaz

ISSN: 2536-5010 / e-ISSN: 2536-5134

DOI: <https://doi.org/10.36222/ejt.1452899>

## ABSTRACT

Single-phase asynchronous motors are preferred in the industry due to their significant features such as robust construction, easy maintenance, and ability to operate in different ambient conditions. They are widely used in various types of automated control systems, cooling and ventilation appliances, and household appliances. Although the structure of the single-phase induction motors is quite simple, modeling and speed control of them are very difficult due to their nonlinear structure. Since traditional speed control methods are not sufficient in nowadays, various methods are being investigated for the speed control of these motors. One of them is to control the speed of a single-phase induction motor by changing the voltage waveform via the power electronic components. In addition to this method, fuzzy logic controller can be preferred in the systems that are difficult to analyze and it does not require a mathematical model. For this reason, in this study, a PWM controlled AC chopper circuit and fuzzy logic controller, which is one of the faster and cheaper methods, are proposed for the speed control of a single phase induction motor. Thus, better results are obtained from the fuzzy logic controller. The system is modeled by MATLAB/Simulink simulations and the results are validated.

## 1. INTRODUCTION

3-phase induction motors are the most widely used motors in the industry. On the other hand, single-phase induction motors are also commonly preferred in low power drive systems. The speed of the induction motors varies very little based on the load. While the speed of direct current motors can be varied within wide limits, the speed of an induction motor can only be increased or decreased to a limited extent by conventional control methods. Induction motors are cheaper in all respects, require less periodic maintenance and do not produce electric arcs during operation. Because of these features, three-phase and single-phase induction motors are the most widely utilized motors in the industry [1]. Despite these advantages, single-phase induction motors have some drawbacks which are being nonlinear and fifth-order, and the complex modeling. Although conventional speed control methods are proper for the linear applications, they are not adequate for the single-phase induction motors, which have a nonlinear structure [2]. Since single-phase induction motors provide a wider speed range for load torques that vary with the square of the speed, Alternating Current (AC) chopper is considered as a suitable solution [3]. In the literature, some studies carried out in this area are handled. Firstly, Zigirkas and Kalomiros propose an asymmetric PWM technique and

fuzzy logic controller for the voltage control of a single phase induction motor [4]. Bouzidi, Harrouz, and Mansouri present a fuzzy logic control of an induction motor based on the variation of the rotor resistance and control of the rotational speed [5]. Agyare, Asiedu, and Biney study a fuzzy logic controller to monitor the behavior of the induction motor based on the amplitude characteristics of the stator currents [6]. Mekrini and Seddik design a fuzzy logic based controller to improve the direct torque control and provide desired torque and flux in the machine [7]. Maghfiroh, Saputro, Fahmizal, and Baballe use the fuzzy logic and PI controllers together for the speed control of the induction motor. Since PID performances degrade when system conditions change, a fuzzy logic is used as a tunable algorithm to change the PID gain [8]. Gobimohan and Murali focus on the design of a closed-loop control for a capacitor-driven asynchronous motor drive with pulse width modulated AC chopper control using a bacteria collection based optimization algorithm. A linearized boost model for the PWM AC chopper is shown for a specific functional point of the drive [9]. Ariff and his/her friends address the problem of the speed control for indirect field steering of an induction motor in the designed system. The problems in the speed control cause the performance degradation of the induction motor in high performance applications. Takagi-Sugeno type fuzzy logic controller is

used as a speed controller to reduce the speed distortion [10]. In the paper, Ahmed and Soliman present the modeling of a motor fed by a pulse width modulated, voltage controlled AC chopper circuit. The advantages of the system are high power factor and low total harmonics in the motor current [11]. Mohan, Pathak, and Dwivedi propose a reactive power based speed control of an induction motor drive for wide speed range applications. This approach involves the control of the reactive power curve entering and leaving the motor for the speed control of the induction motor using a fuzzy logic method. The main advantage of this approach is to achieve the desired power factor operation [12]. Daoudi, Lazrak, Ouanjli, and Lafkih develop a fuzzy direct torque control for a two-level inverter driven induction motor drive. The aim of them is to improve the system performance by reducing the electromagnetic torque and stator flux fluctuations while improving stator current waveforms. A comparative study between direct torque control based on the fuzzy logic and nonlinear sliding mode direct torque control is performed by using MATLAB/Simulink [13]. Muthamizhan, Shivaj, and Aijaz control the speed of the induction motor in the study by using the V/f control technique via three phase multilevel inverters. The multilevel inverter used are 7, 9, and 11 level diode clamped multilevel inverters. The V/f control system is based on a fuzzy logic controller which replaces the conventional closed loop proportional integral controller for the induction motor drive. The study is realized by a MATLAB/Simulink software including a multilevel inverter with a V/f control [14]. As mentioned above, AC chopper circuit, PWM signals, and fuzzy logic are the preferred and studied methods for the speed control of a single phase induction motor. These methods, which are also easy to implement, are open to improvement.

In this paper, hysteresis band PWM controlled AC circuit and fuzzy logic controller are studied for the speed control of a single phase induction motor. The high-speed power switches used in the AC chopper circuit are preferred to control the speed of the single-phase induction motor by changing the voltage waveform of the motor. PWM signals generated by the hysteresis band are used to trigger the power electronics elements. Depending on this control method, a fuzzy logic controller is used to get better results especially in the speed graph. With the fuzzy logic method, which is widely preferred in complex systems, a closed loop is created and the model gives better results.

The methods used in the design are explained in the Sections 2, 3, 4 and 5 of the study. Sections 6 and 7 present the design and results.

## 2. A SINGLE PHASE INDUCTION MOTOR MODEL

A single-phase induction motor with auxiliary winding is used in the model.

### 2.1. Auxiliary Winding Motors

A motor consisting of two different stator windings placed at  $90^\circ$  to each other as shown in Figure 1 is called an auxiliary winding motor. When the motor speed reaches 75-80% of the synchronous speed, the start switch disables the auxiliary winding. This switch is opened by the centrifugal force. The rotor of this type motor is a squirrel cage. In the starting process, the two windings are connected in parallel to each other and also to the supply source [15].

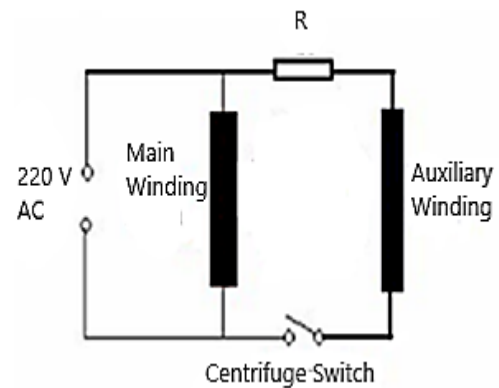

Figure 1. Equivalent circuit of a single phase induction motor with auxiliary winding.

### 2.2. Mathematical Model of a Single Phase Induction Motor

In order to analyze a single-phase asynchronous motor, a mathematical model is required. With the help of the equivalent circuit given in Figure 2, the d-q model is created and can be analyzed in this way [16]. In the equations,  $V$ ,  $\lambda$ ,  $I$ ,  $R$ , and  $L$  are the voltage, flux, current, resistance, and inductance value for the d-q axis, respectively.  $d\theta/dt$  is the rotor angular speed,  $T_m$  is the motor torque,  $T_y$  is the load torque,  $\omega$  is the angular speed and  $j$  is the coefficient of the inertia. Sub-indexes  $s$ ,  $r$ ,  $d$ , and  $q$  represent the stator, rotor, d-axis, and q-axis, respectively.

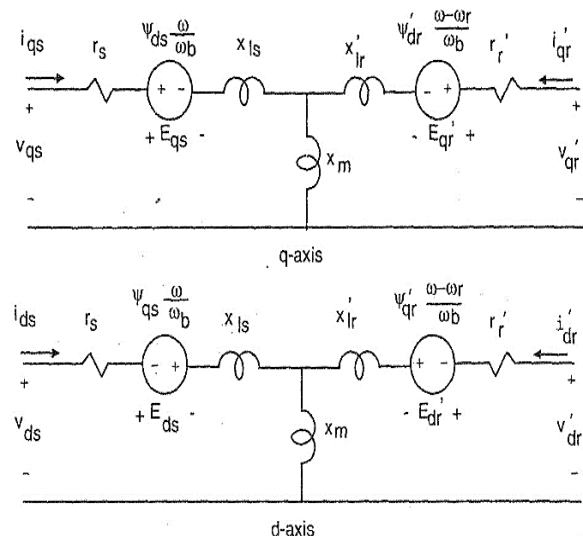

Figure 2. Circuit of a single phase induction machine [16].

The voltage equations are given below.

$$V_{qs} = R_{qs} * I_{qs} + \frac{d\lambda_{qs}}{dt} \quad (1)$$

$$V_{ds} = R_{ds} * I_{ds} + \frac{d\lambda_{ds}}{dt} \quad (2)$$

$$V_{qr} = R_r * I_{qr} - \lambda_{dr} * \frac{d\theta_r}{dt} + \frac{d\lambda_{qr}}{dt} \quad (3)$$

$$V_{dr} = R_r * I_{dr} + \lambda_{qr} * \frac{d\theta_r}{dt} + \frac{d\lambda_{dr}}{dt} \quad (4)$$

The fluxes can be obtained from the voltage equations as follows

$$\lambda_{qs} = \int (V_{qs} - R_{qs} * I_{qs}) dt \quad (5)$$

$$\lambda_{ds} = \int (V_{ds} - R_{ds} * I_{ds}) dt \quad (6)$$

$$\lambda_{qr} = \int (V_{qr} - R_r * I_{qr} + \lambda_{dr} * \frac{d\theta_r}{dt}) dt \quad (7)$$

$$\lambda_{dr} = \int (V_{dr} - R_r * I_{dr} - \lambda_{qr} * \frac{d\theta_r}{dt}) dt \quad (8)$$

The flux equations can be given as follows

$$\lambda_{qs} = L_{lqs} * I_{qs} + L_{mq} * (I_{qs} + I_{qr}) \quad (9)$$

$$\lambda_{ds} = L_{lds} * I_{ds} + L_{md} * (I_{ds} + I_{dr}) \quad (10)$$

$$\lambda_{qr} = L_{lqr} * I_{qr} + L_{mq} * (I_{qs} + I_{qr}) \quad (11)$$

$$\lambda_{dr} = L_{lrr} * I_{dr} + L_{md} * (I_{ds} + I_{dr}) \quad (12)$$

The current equations can be written as follows

$$I_{qs} = \frac{1}{L_{lqs}} * (\lambda_{qs} - L_{mq} * (I_{qs} + I_{qr})) \quad (13)$$

$$I_{ds} = \frac{1}{L_{lds}} * (\lambda_{ds} - L_{md} * (I_{ds} + I_{dr})) \quad (14)$$

$$I_{qr} = \frac{1}{L_{lqr}} * (\lambda_{qr} - L_{mq} * (I_{qs} + I_{qr})) \quad (15)$$

$$I_{dr} = \frac{1}{L_{lrr}} * (\lambda_{dr} - L_{md} * (I_{ds} + I_{dr})) \quad (16)$$

The motion equation of the system is given below.

$$T_m = \frac{P}{2} * (\lambda_{qr} * I_{dr} - \lambda_{dr} * I_{qr}) \quad (17)$$

$$j * \frac{d\omega_r}{dt} = T_m - T_y \quad (18)$$

### 3. PWM Controlled AC Chopper

#### 3.1. PWM Controlled AC Chopper

AC voltage choppers are widely used in the speed control of 3-phase and single-phase induction motors, especially for load torques that vary with the square of the speed. The control methods used in these choppers cause non-uniform waveforms in the supply voltages and load currents. The single-phase pulse width modulation controlled AC chopper proposed by Kwon has high power factor, low harmonic input current, and high efficiency. In the PWM controlled AC Chopper for motor speed control, power switches are used to interrupt the source voltage. This method causes the pulse width of the AC voltage waveform to change. Therefore, this AC voltage control method is called symmetrical pulse width modulation. The circuit diagram of the system is given in Figure 3 [17].

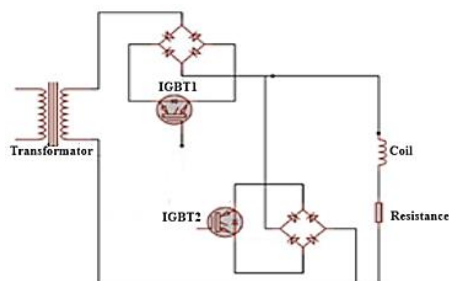

Figure 3. Symmetric PWM AC chopper circuit diagram [17].

#### 3.2. Hysteresis Band PWM

Hysteresis band current control to obtain the power switching signal in a way that reduces the current error [18]. As a result of this technique, a significant improvement is provided in the quality of the load current in the system simulation. The advantages of the system are its ease of industrial implementation, cost, and reliability [19]. This

PWM method is commonly used in the current-controlled PWM applications. A feedback loop is utilized to measure the inrush value of the motor current. A sinusoidal current reference is monitored within a defined hysteresis band as shown in Figure 4. When the actual current exceeds the upper hysteresis band, the upper switch on one leg of the drive is cut off and the lower switch conducts. This is a current reduction state. If the current falls below the hysteresis band, the upper switch conducts and the lower switch cuts. When a positive voltage is applied to the phase, the current increases. Hysteresis band PWM is used to keep the motor current within the hysteresis band. This is an easy method to implement the PWM and since the response time of the controller is very fast, the controller does not need any other parameter other than the value of the current. Besides these advantages, this modulation method also has some disadvantages. The first one is that the PWM switching frequency does not have a fixed value, however, it varies within a frequency band. When the current ripple is not desired, the hysteresis band is narrowed, resulting in more switching per period (switching losses also increase at high switching frequency) [20].

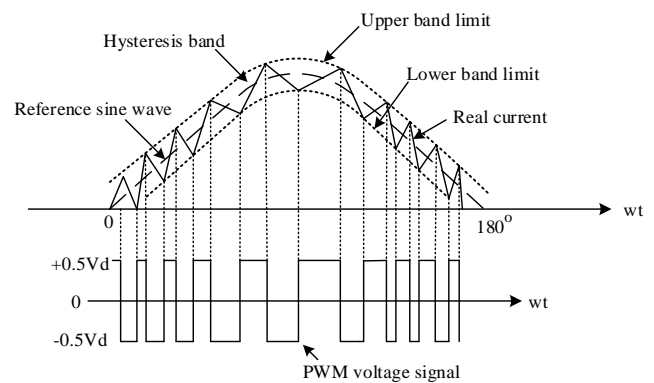

Figure 4. Principle schematic of the hysteresis band PWM [20].

#### 3.3. Fuzzy Logic Controller

A fuzzy logic is an expert system that works from a knowledge representation based on the set theory. It consists of a database that counts all the information about the process and it allows us to define the membership functions and fuzzy rules of the fuzzy system [21]. Fuzzy logic controllers are preferred in the control of time-varying and nonlinear systems which mathematical model cannot be determined precisely. The concept of them had been first introduced by Lutfi A. Zadeh. In the fuzzy logic structure, the relationships between concepts are represented by verbal or numerical expressions. In the control process, there is a linguistic control structure created by an expert persons [22]. The fuzzy logic system has been proven to give better results and better torque response compared to classical methods for evaluating speed control performance [23]. Hence fuzzy logic speed controller is preferred due to its simplicity and low implementation cost. In addition, it exhibits strong performance in nonlinear controller systems without designing any mathematical model [24]. A fuzzy logic controller consists of three basic parts which are fuzzification, rule-based inference mechanism, and stabilization as shown in Figure 5 [25].

### 4. EXPERIMENTS

#### 4.1. System Design

The system model is realized with MATLAB/Simulink package program. In the designed model, the speed control of a single-phase induction motor with AC chopper controlled by asymmetric PWM signals generated from hysteresis band.

The tag values of the single-phase induction motor are given in Table 1. When the motor speed reaches 75% of the synchronous speed, the auxiliary winding is removed from the circuit.

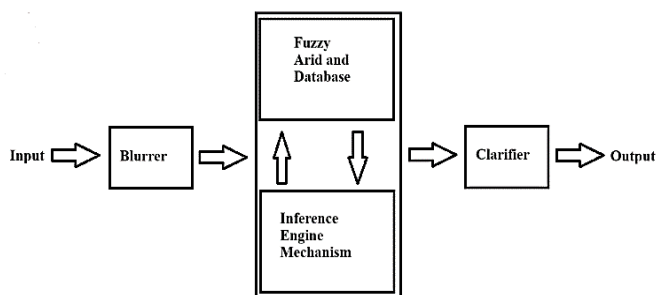

Figure 5. Block diagram of a fuzzy logic controller [25].

TABLE I

LABEL INFORMATION FOR SINGLE PHASE INDUCTION MOTOR.

Symbol	Engine Information	Numeric Values
W	motor power	8.98 W
V	voltage	230 V
Hz	frequency	50 Hz
$\Omega$	Main winding resistance(stator)	149.5 $\Omega$
H	Main winding inductance(stator)	0.58001 H
$\Omega$	Main winding resistance(rotor)	162.5 $\Omega$
H	Main winding inductance(rotor)	0.58001 H
H	Main winding common inductance	3.1344 H
$\Omega$	Auxiliary winding resistance	1625 $\Omega$
H	Auxiliary winding inductance	0.029 H
j	Moment of inertia	0.0146 kg*m <sup>2</sup>
N <sub>s</sub> /N <sub>r</sub>	Winding ratio	1.18
p	Number of poles	4

the shaft of the single-phase induction motor. In the previous model, the torque generated by the motor is used for the input of the hysteresis band. However, here, the input of the hysteresis band is changed. Firstly, a closed loop is created with a fuzzy logic controller. In the first input of the fuzzy logic controller designed with two inputs and one output, the speed error signals obtained from comparing the speed of the motor and the reference speed are used. The reference speeds are chosen as 1000-1200-1300 and 1400 rpm. The model is re-run for each reference speed value. For the second input, the derivative of the speed error signals is taken and the speed error change signals are obtained. The torque change signals obtained from the output of the fuzzy logic controller are summed with the torque signals produced by the motor and used for the input of the block where the hysteresis band is generated. Thus, only the input signal of the hysteresis band generation block is changed, the shape and values of the reference signal are used for the hysteresis band and the values of the relay are not changed. As shown in Figure 6, seven different load values (0.05-0.055-0.06-0.065-0.065-0.07-0.75-0.08 Nm) are gradually connected to the motor shaft incrementally starting from the 25th second.

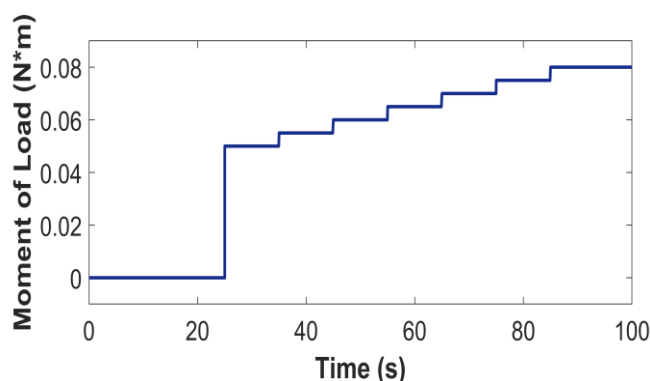

Figure 6. Load values connected to the motor.

### 4.2. Research Findings

In this study, it is aimed to create a fuzzy logic closed-loop model to prevent the speed drop when a load is connected to

The designed model is given in Figure 7. The model is designed using a fuzzy logic controller. This consists of two inputs, one output, and seven membership functions.

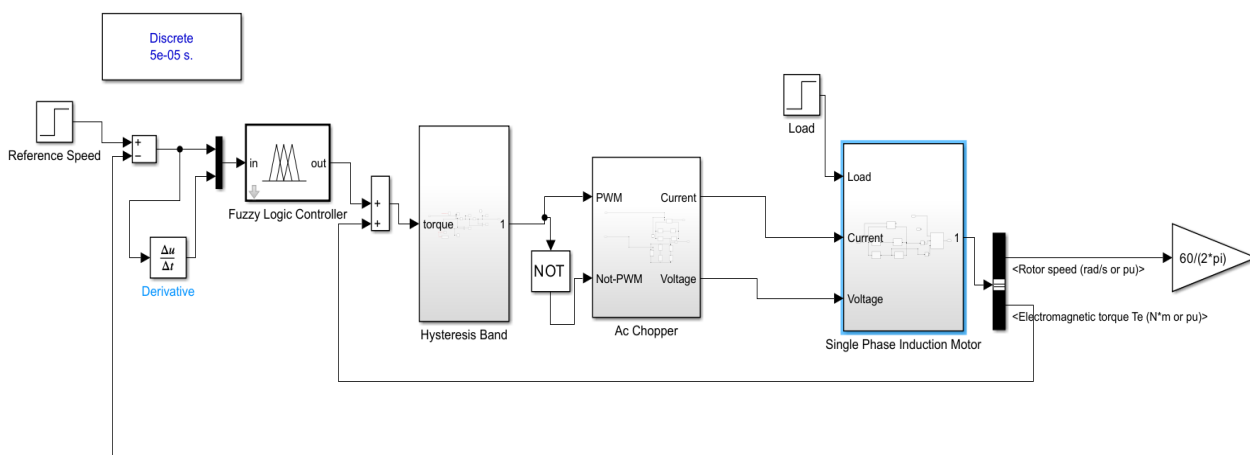

Figure 7. Model for the speed control of a single phase induction motor using hysteresis band PWM with a fuzzy logic controller.

The model is tested for different reference speed values and the same controller is used for these speed values. The rule surface of the fuzzy logic controller is given in Figure 8.

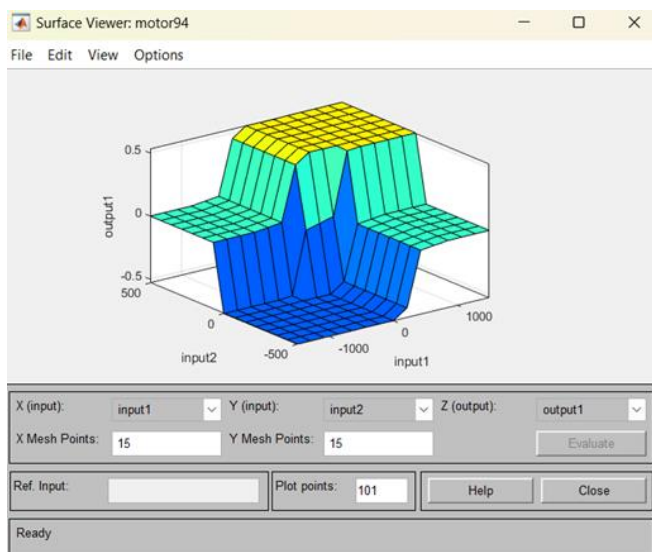

Figure 8. Rule surface.

The speed graph of the single-phase induction motor controlled by an asymmetric PWM without a fuzzy logic controller is given in Figure 9 and Figure 10 for unloaded and loaded conditions.

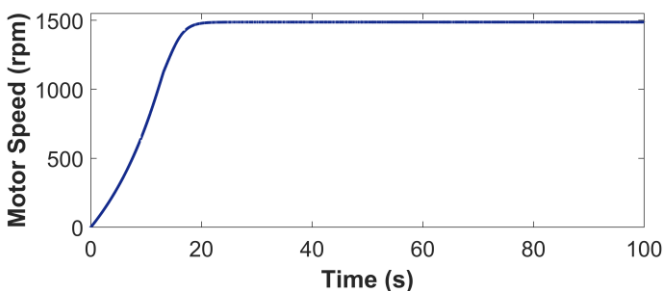

Figure 9. Speed graph for no-load condition.

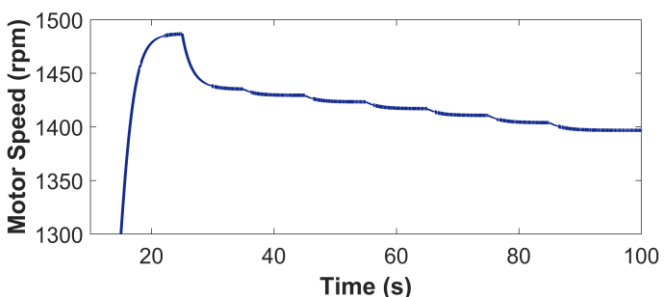

Figure 10. Speed graph for loaded state.

After the control system is created by the fuzzy logic controller, the graphical results obtained for some reference speeds which are 1000-1200-1300, and 1400 rpm and different load values are given as below.

By using 1000 rpm reference speed value and load values given in Figure 6, the speed, voltage, current, and torque curves produced by the motor are given in Figures 11-14.

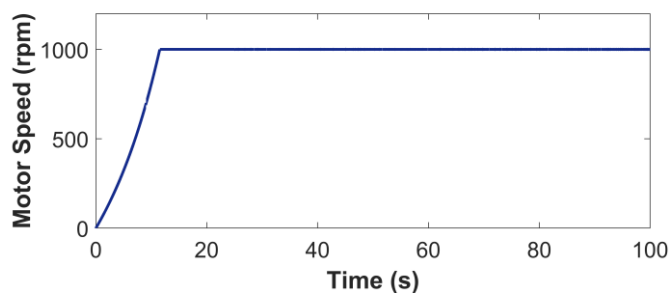

Figure 11. Speed curve of the motor for 1000 rpm reference speed value.

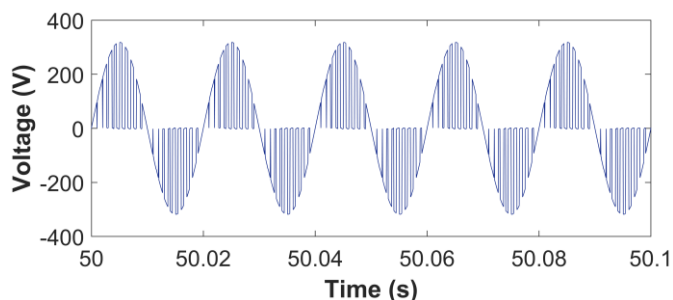

Figure 12. Voltage curve of the motor for 1000 rpm reference speed value.

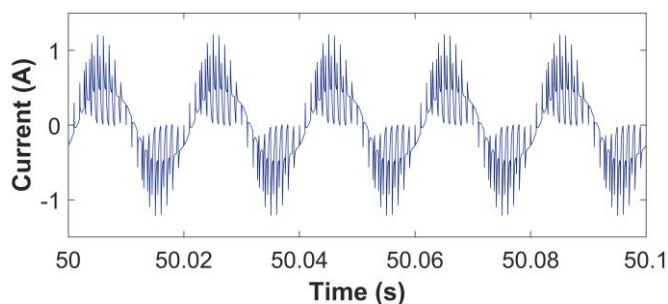

Figure 13. Current curve of the motor for 1000 rpm reference speed value.

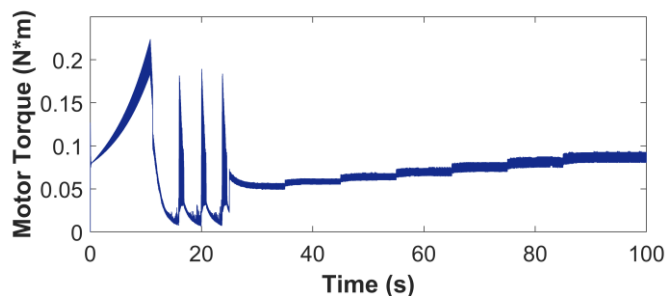

Figure 14. Torque curve produced by the motor for 1000 rpm reference speed value.

By using 1200 rpm reference speed value and the load values given in Figure 6, the speed, voltage, current, and torque curves produced by the motor are shown in Figures 15-18.

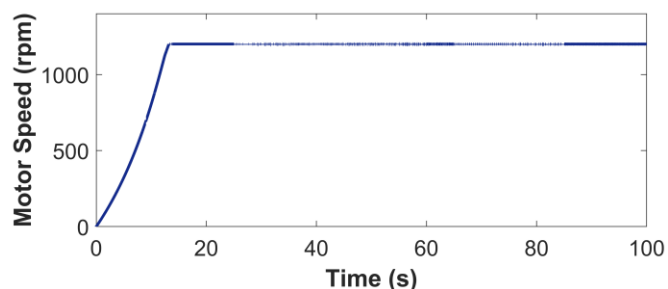

Figure 15. Speed curve of the motor for 1200 rpm reference speed value.

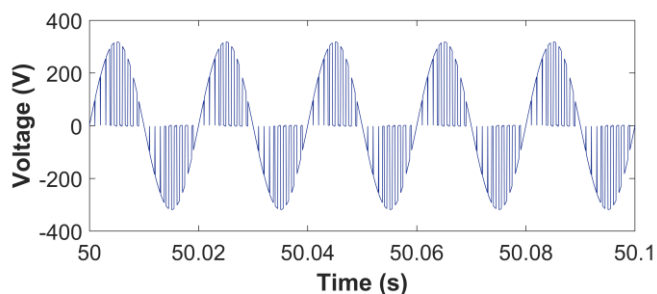

Figure 16. Voltage curve of the motor for 1200 rpm reference speed value.

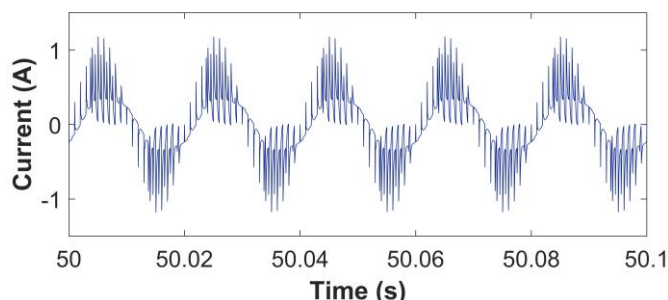

Figure 21. Current curve of the motor for 1300 rpm reference speed value.

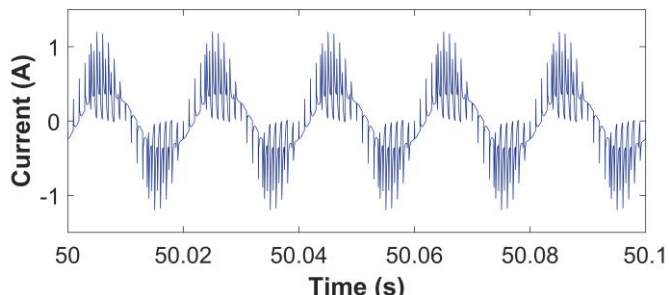

Figure 17. Current curve of the motor for 1200 rpm reference speed value.

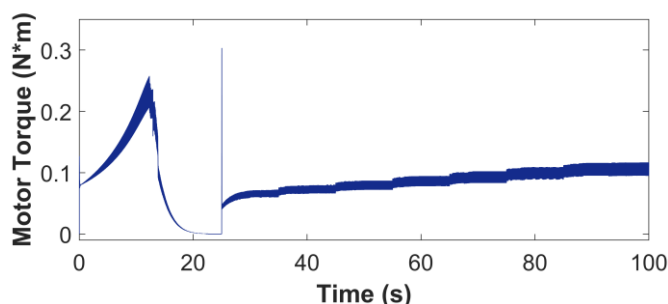

Figure 22. Torque curve produced by the motor for a reference speed of 1300 rpm.

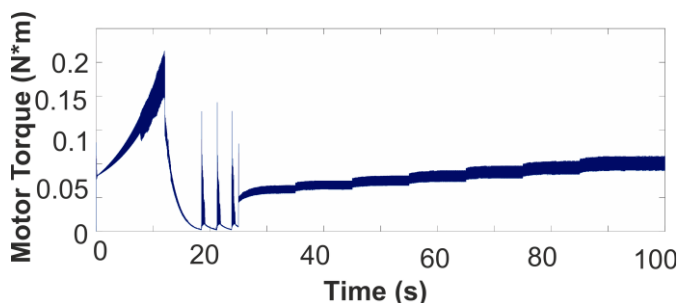

Figure 18. Torque curve produced by the motor for 1200 rpm reference speed value.

By using the reference speed of 1300 rpm and load values given in Figure 6, the speed, voltage, current, and torque curves produced by the motor are drawn in Figures 19-22.

By using 1400 rpm reference speed value and the load values given in Figure 6, the speed, voltage, current and torque curves produced by the motor are illustrated in Figures 23- 26.

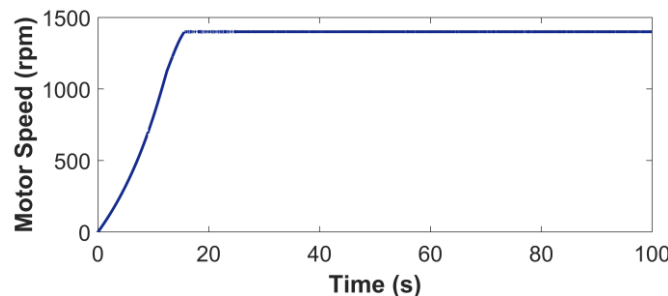

Figure 23. Speed curve of the motor for 1400 rpm reference speed value.

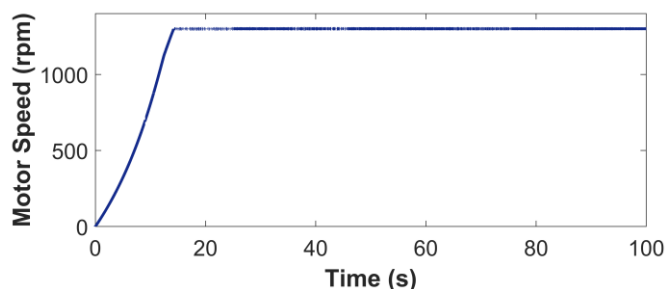

Figure 19. Current curve of the motor for 1300 rpm reference speed value.

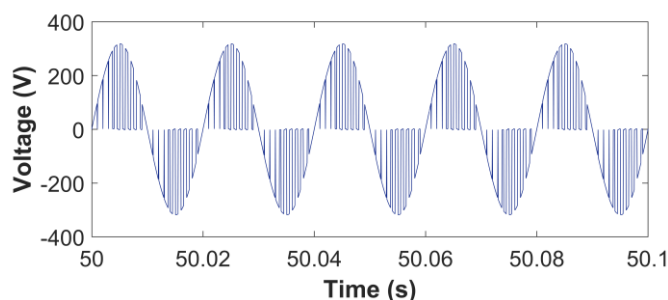

Figure 24. Voltage curve of the motor for 1400 rpm reference speed value.

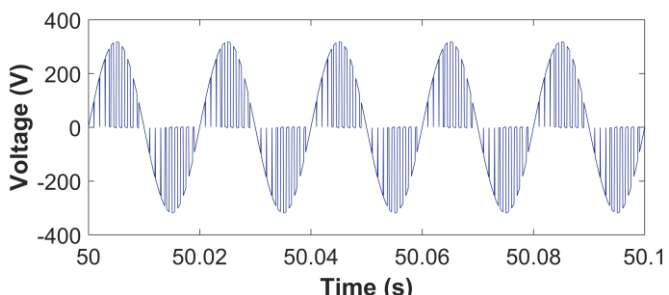

Figure 20. Voltage curve of the motor for 1300 rpm reference speed value.

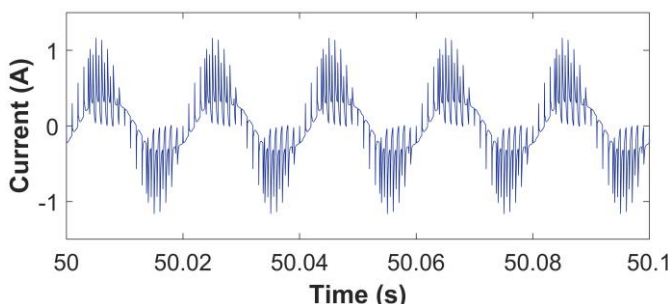

Figure 25. Current curve of the motor for 1400 rpm reference speed value.

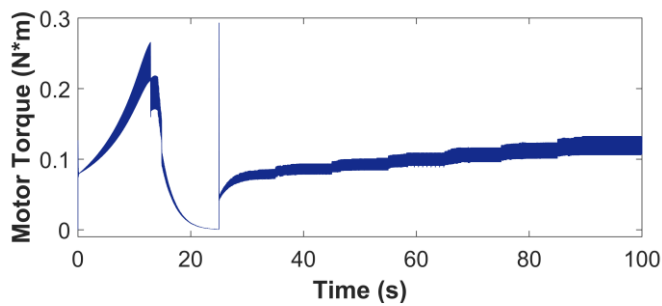

Figure 26. Torque curve produced by the motor for a reference speed of 1400 rpm.

## 5. CONCLUSION

In this paper, a solution method for the speed control problem of the single-phase induction motors which is one of the biggest problems of these motors is proposed. Thus, it is aimed to increase the usage areas of these motors. The speed control of the motor is achieved by the help of an AC chopper that changes the voltage waveform applied to the motor. A hysteresis band is created for triggering the power electronics elements. For the inputs of the hysteresis band, the torque generated by the motor and the reference signal are used. A saw tooth is also chosen for the reference signal. The PWM signals obtained by comparing the motor torque and reference signal are utilized for triggering the power electronics switches. The speed control of the motor is carried out, however, when a load is connected to the motor shaft, a fall is observed in the speed curve.

A closed loop system is created by using a fuzzy logic controller to prevent the drops in the speed curves. At this stage, the torque input produced by the motor used for the hysteresis band is changed. For the first input of the fuzzy logic controller, the speed error is obtained by the difference between the reference speed value and the motor speed. For the second input, the derivative of the speed error value is taken to obtain the speed error change. The torque values obtained from the output of the fuzzy logic controller and the produced by the motor are summed and used as the new input of the hysteresis band. Thus, power electronics switches are triggered with the new PWM signals obtained. As a result, it is observed that the proposed fuzzy logic speed controller method gives successful results in the closed loop system.

## REFERENCES

- [1] A. H. Saçkan, "Asenkron Motorlar," Birsen Yayınevi, 1994.
- [2] J. Holtz, "Speed Estimation and Sensorless Control of Drives," Proc. IEEE Int. Conf. On Ind.Elec.Cont. And Intr. (IECON'93), November 1993, Maui, Book of Proceedings : 649-654 .
- [3] N. Jain, N. H. Funde, N. P. Meshram, S. Shrikant, "Speed Control of Single Phase Induction Motor Using AC Chopper by Asymmetrical PWM Technique," *GRD Journal for Engineering*, vol. 3, no. 10, 2019.
- [4] G. Zigirkas, J. Kalamiros, "Voltage Control of Single-Phase Induction Motors Using Asymmetrical PWM and Fuzzy Logic," *5 th International Conference on Modern Circuits and Systems Technologies*, 2016.
- [5] M. Bouzidi, S. Harrouz, S. Mansori, "Control and Automation of Asynchronous Motor Using Fuzzy Logic," *Algerian Journal of Renewable Energy and Sustainable Development*, vol. 1, no. 2, pp. 12415-12422, 2014.
- [6] O. R. Agyare, A. B. Asiedu-Asante, A. R. Biney, "Fuzzy Logic Based Condition Monitoring of a 3-Phase Induction Motor".
- [7] Z. Mekrini and S. Bri, "Fuzzy Logic Application for Intelligent Control of An Asynchronous Machine," *Indones. J. Electr. Eng. Comput Sci.*, vol. 7, no. 1, p. 61, 2017.

- [8] H. Maghfiroh, J. Slamet Saputro, F. Fahmizal, and M. Ahmad Baballe, "Adaptive Fuzzy-PI for Induction Motor Speed Control," *jfsc*, vol. 1, no.1, pp. 1-5, 2023.
- [9] G. M. Sivasubramanian and M. NArayanamurthy, "Implementation of PWM AC Chopper Controller for Capacitor Run Induction Motor Drive Via Bacterial Foraging Optimization Algorithm," *Int. J. Reconfigurable Embed. Syst. (IJRES)*, vol. 9, no.3, pp. 169-177, 2020.
- [10] R. M. Ariff, D. Hanafi, W. M. Utomo, N. M. Zin, S. Y. Sim, and A. A. Bohari, "Takagi-Sugeno Fuzzy Perpose as Speed Controller in Indirect Field Oriend Control of Induction Motor Drive," *IAES Int. J. Artif. Intell. (IJ-AI)*, vol. 5, no. 4, p.149, 2015.
- [11] M. M. R. Ahmed, M. Soliman, "Speed Control of AC Series Motor Using AC Chopper Voltage Control," *IEEE Electrical Power &Energy Conference*, 2010.
- [12] H. Mohan, M. K. Pathak, and S. K. Dwivedi, "Reactive Power Based Speed Control of Induction Motor Drive using Fuzzy Logic for Industrial Application," in *2020 IEEE International Conference on Power Electronics, Smart Grid and Renewable Energy (PESGRE2020)*, 2020.
- [13] S. El Daoudi, L. Lazrak, N. El Ouanjli, M. Ait Lafkih M, "Sensorless Fuzzy Direct Torque Control of Induction Motor With Sliding Mode Speed Controller," *Computer and Electrical Engineering*, vol. 96, no. 107490, p.107490, 2021.
- [14] T. Muthamizhan, B. Shivaji, M. Aijaz, "Fuzzy Logic Controller Based Multilevel Inverters Integrated Speed Control of Induction Motors," in *2022 3rd International Conference for Emerging Technology(INCET)*, 2022.
- [15] G. Bal, *Özel Elektrik Makinaları*, Seçkin Yayıncılık, 2011.
- [16] S. Ünal, M. Özdemir, S. Sünter, "Voltage and Frequency Control of a Single-Phase Self-Excited Generator," *International Aegean Conference on Electrical Machines and Power Electronics*, Istanbul-Turkey, pp.509-514, May 2004.
- [17] Bashi S.M., Mailah N. F., Cheng W.B., (2008). "Development of a Single Phase AC Controller", *Pertanika J.Sci.&Technol.* Vol 16, No.2, pp.119-127, 2008.
- [18] R. R. Duvvuru, T. S. K. Manoj, A. V. S. Reddy, R. R. Duvvuru, C. N. Kumar, and C. R. Reddy, 2021. "Fuzzy Logic Controller Based Three-Phase PWM AC Chopper Fed Induction Motor Drive With HBCC Technique," *International Journal of Electrical Engineering and Technology(IJEET)*, vol. 12, no. 5, 2021.
- [19] N. Çatalbaş, C. Çatalbaş, S. Sunter, "Design and Implementation of a Hysteresis Band Current Controller Three-Phase AC Chopper System," *International Journal of Renewable Energy Research*, June, 2020.
- [20] H. Çelik, H. Kürüm, "Düzenli Örneklemeli Sinüzoidal PWM'in Asenkron Motorun Hız Kontrolündeki Etkileri," *Elektrik-Elektronik-Bilgisayar Mühendisliği 11. Ulusal Kongresi ve Fuarı Bildirileri*, 2005.
- [21] A. Herizi, A. Bouguerra, S. Zeghlache, R. Rouabhi, R. Mahmoudi, H. E. Smaini, 2020. "Type-2 Sugeno Fuzzy Logic Inference System for Speed Control of a Doubly-Fed Induction Motor," in *2020 1st International Conference on Digitization and its Application (ICDA'2020)*, 2020.
- [22] İ. Alışkan, S. Ünsal, "Farklı Çıkarm Yöntemlerine Sahip Bulanık Mantık Denetleyicileri Kullanılarak Kalıcı Miknatıslı Senkron Motorun Hız Denetimi," *Pamukkale Üniversitesi Mühendislik Bilimleri Dergisi*, 24(2), 185-191, 2018.
- [23] H. Maghfiroh, J. S. Saputro, F. Adriyanto, A. Sujono, R. L. Lambang, 2020. "Performance Evaluation of Fuzzy-PID in Speed Control of Three Phase Induction Motor," *ICIMECE*, 2020.
- [24] M. A. Hannan, J. A. Ali, M. S. H. Lipu, A. Mohamed, P. J. Ker, T. M. I. Mahlia, M. Mansor, A. Hussain, K. M. Muttaqi, Z. Y. Dong , "Role of Optimization Algorithms Based Fuzzy Controller in Achieving Induction Motor Performance Enhancement," *Nature Communications*, vol. 11, no. 1, p. 3792, 2020.
- [25] G. Kamalapur, M. S. Aspalli "Direct Torque Control and Dynamic Performance of Induction Motor Using Fractional Order Fuzzy Logic Controller," *International Journal of Electrical and Computer Engineering(IJECE)*, vol.13, no.4, pp.3805-3816, 2023.

## BIOGRAPHIES

**Ece Yılmaz** received her bachelor's degree in Electrical and Electronics Engineering from Fırat University in 2020. She started her master's degree in electrical and electronics engineering at Fırat University in 2021. She is currently a graduate student at Fırat University, Department of Electrical and Electronics Engineering. His research interests are electric machines and drive systems.

**Sencer Ünal** born in 1978 in Elazig-Turkey. Received B.Sc., M.Sc. and Ph.D degrees in Electrical Engineering from Firat University (Elazig-Turkey) in 1999, 2002 and 2009, respectively. He is currently Assistant Professor in the Electrical and Electronic Dept. of Firat University. His area of interest is Electrical Machines and Power Electronics.

**Mehmet Özdemir** born in 1958 in Elazig-Turkey. Received B.Sc., M.Sc. and Ph.D degrees in Electrical Engineering from Firat University (Elazig-Turkey) in 1980, 1984 and 1993, respectively. He is currently Associate Professor in the Electrical and Electronic Dept. of Firat University. His area of interest is Electrical Machines and Drives. He retired in 2024.