

Evaluation of three-phase neutral-point-clamped PFC rectifier implemented with isolated DC-DC converters for EV fast charger

EA hızlı şarj cihazı için izoleli DC-DC dönüştürücülerle uygulanan üç fazlı nötr noktadan sıkıştırılmış PFC doğrultucunun değerlendirilmesi

Merve MOLLAHASANOGLU^{1*}, Hakkı MOLLAHASANOGLU², H. Ibrahim OKUMUS¹

¹Department of Electrical Electronics Engineering, Faculty of Engineering, Karadeniz Technical University, Trabzon, Turkey.
merve.aydin@ktu.edu.tr, okumus@ktu.edu.tr

²Department of Electrical Electronics Engineering, Faculty of Engineering, Recep Tayyip Erdogan University, Rize, Turkey.
hakkimollahasanoglu@erdogan.edu.tr

Received/Geliş Tarihi: 07.03.2023
Accepted/Kabul Tarihi: 22.08.2023

Revision/Düzeltilme Tarihi: 19.08.2023

doi: 10.5505/pajes.2023.89195
Research Article/Araştırma Makalesi

Abstract

In this study, a three-phase AC/DC neutral point clamped (NPC) power factor corrected (PFC) multilevel converter for off-board chargers of Electric Vehicles (EVs) is evaluated. The rectifier analysis has been tested by extensive simulations in combination with isolated DC-DC converters. This rectifier provides unity input power factor and efficiency above 96% for DC fast chargers rated at power levels up to 100 kW. The voltage ripple is below 0.5% for 800 Volt DC voltage. The current ripple is below 0.1% for 125 Ampere DC current. When the EV fast charger is evaluated with both isolated DC-DC converters, the NPC rectifier has less than 1% THD. This multilevel converter is highly efficient in terms of capacitor voltage balancing. The system has a simple control structure and does not require an extra PFC circuit. The converter operation and design calculations are presented with simulation studies. The simulation results of the system evaluated for isolated DC-DC converters demonstrate the validity and flexibility of the proposed charging system.

Key words: Battery charger, Electric vehicles (EVs), Multilevel converter, Neutral point clamped (NPC) converter, Power factor correction (PFC) converter, Power quality.

Özet

Bu çalışmada, Elektrikli Araçların (EA'lar) harici şarj cihazları için üç fazlı bir AC/DC nötr nokta kenetlemeli (NPC) güç faktörü düzeltilmiş (PFC) çok düzeyli dönüştürücü değerlendirilmektedir. Doğrultucu analizi, izole edilmiş DC-DC dönüştürücüler ile kapsamlı simülasyonlarla test edilmiştir. Bu doğrultucu, 100 kW'a kadar güç seviyelerinde derecelendirilen DC hızlı şarj cihazları için birlik giriş güç faktörü ve %96'nın üzerinde verimlilik sağlar. 800 Volt DC gerilimi için gerilim dalgalanması %0.5'in altındadır. 125 Amper DC akım için akım dalgalanması %0.1'in altındadır. EV hızlı şarj cihazı, her iki izole DC-DC dönüştürücü ile değerlendirildiğinde, NPC doğrultucunun harmoniği %1'den azdır. Bu çok seviyeli dönüştürücü, kapasite voltaj dengelemesi açısından oldukça verimlidir. Sistem basit bir kontrol yapısına sahiptir ve ekstra bir PFC devresi gerektirmez. Dönüştürücü çalışma ve tasarım hesapları benzetim çalışmaları ile sunulmuştur. İzoleli DC-DC dönüştürücüler için değerlendirilen sistemin benzetim sonuçları, önerilen şarj sisteminin geçerliliğini ve esnekliğini göstermektedir.

Anahtar kelimeler: Batarya şarj cihazı, Elektrikli araçlar, Çok seviyeli dönüştürücü, Nötr nokta kenetlemeli (NPC) dönüştürücü, Güç faktörü düzelten (PFC) dönüştürücü, Güç kalitesi.

1 Introduction

Since the use of clean and efficient energy source is very important, interest in electric vehicles (EV) is steadily increasing. However, EV users have concerned about the limited range and charging times of electric vehicles. Therefore, researchers focus on developing fast charging infrastructure and EV's batteries.

Traditional EV fast chargers have two-stage structure. These chargers consist of an AC/DC converter with PFC circuit and an isolated DC-DC converter. Figure 1 shows a general fast charging topology. Since off-board DC chargers are high-power applications, they are usually three-phase AC feed. There is a filter component and an AC to DC conversion stage. In addition, there is an isolated DC-to-DC converter inside the charger before the plug attached to the electric vehicle. The charger is connected directly to the EV's battery. There is a communication link between the charger and the battery management system to control the charging process and safety procedures [1]-[3].

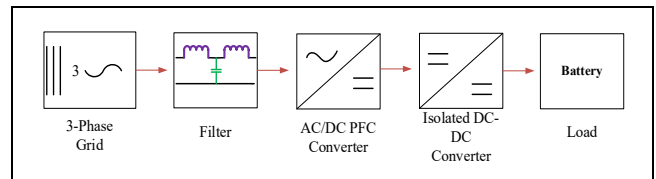

Figure 1. General DC fast charger block diagram.

Three-phase multi-level AC/DC bi-directional PFC topologies are more important in EV fast charging station [4]. These topologies are two-level voltage source converters (VSC) and three-level converters such as Flying Capacitor Converters (FLC), T-type converters and Neutral Point Clamped (NPC) Converters in EV fast charging station [5]. The main problem in these rectifiers is designing modulation schemes and their control. Two-level VSC is the simplest topology and uses only six active switches. When the two-level one is compared to three-level topology, two-level topology should use higher grid filters [6]. However, its control is simpler than the three-level (3L) converters. The main advantage of three-level topologies is that dv/dt voltages on switching devices are less. A critical

*Corresponding author/Yazışılan Yazar

issue for FLCs is maintaining capacitor voltage balance while minimizing rectifier input current harmonics. They are more complex than NPC's [7]. To overcome higher power levels, it is necessary to reduce stress on the components. Therefore, it is reasonable to consider multilevel AC/DC converters as fast charger components [8]-[10].

To enable fast charging in electric vehicles (EVs), an AC/DC converter followed by an isolated DC-DC converter is necessary. Isolation between the grid and the battery is important for the EV battery to not be affected by the charging system [11]. These topologies are PSFB (phase-shift full-bridge), LLC, DAB (dual active bridge) [12], and CLLC converters [13]. The reason why is called this study for fast charging stations is that the NPC rectifier has been evaluated for isolated dc-dc converters (DAB and PSFB) used for ultra-fast charging.

Three-phase 3L-NPC PFC structures are frequently seen as inverters in the literature as in [14], [15]. In this study, the 3L-NPC PFC converter, which is considered as a rectifier, is evaluated together with the isolated DC-DC converters. Three-phase 3L-NPC converter is suitable for international standards such as IEEE 519 [16] and IEC 61000-3-2/4. Modulation is the heart of the converter. Finding the optimum modulation strategy improves power quality. Non-isolated DC-DC circuit offers only a 30 kW system with a 3L-NPC converter in [17]. But this study offers 100 kW system with the 3L-NPC converter using isolated DC-DC converters. Similarly, two-level Vienna rectifiers are less efficient than 3L-NPC [9], [10]. Since [18] and [19] highlights that 3L-NPC converter has good performance with high switching frequency; in this study switching frequency was also evaluated. The 3L-NPC converter topology can use active switches instead of clamped diodes to reduce switching losses as in [20], [21]. However, drive circuit is required for each switch. This complicates the control. Generally, off-board DC fast chargers provide power of 50 kW and above [8], [17] and [22]. These chargers transfer DC power to the EV's battery via an isolated DC-DC converter. Isolated DC-DC converters are controlled at fast charging stations, in order for the battery to be charged in a short time [23].

The aim of this study is to evaluate the Three-phase three-level NPC rectifier topology for EV fast charging stations. In this study, two different 100 kW chargers were designed. In these chargers, the NPC topology, which appears as an inverter in the literature, has been extensively evaluated. It is aimed to find the optimum parameters of the topology considered for fast charging. The optimum circuit parameters of the three-level AC/DC NPC circuit considered for a complete EV charger in Figure 1 are presented in this study. The system is within acceptable limits is a source of inspiration. This rectifier, designed for full load at 100 kW, has been evaluated in detail with simulation studies for two different isolated DC-DC converters which are PSFB and DAB. THD analysis of the rectifier input current, ripple factor of 800 V rectifier DC output voltage and 125 A DC output current are reviewed, and the power factor is calculated according to the power change in the load. The grid current THD, the DC output voltage ripple and DC current ripple are less than international standards. Two different DC chargers show good performance on high power levels without an extra PFC circuit and without much stress on rectifier's components with simple control method. The 3L-NPC PFC rectifier efficiency was examined with two different DC-DC converters and battery system using SPWM modulation technique. The appropriate converter switching frequency is

estimated by looking at the grid current harmonic. While 800 Volt DC conversion is carried out with a multilevel rectifier from the grid, the isolated DC-DC side allows electric vehicle battery packs to be charged. In this study, three phase three level AC/DC NPC PFC rectifier is discussed for EV fast charging station. This rectifier has been evaluated together with PSFB and DAB converters. The results are acceptable limits for 100 kW EV charger with the classical triangular carrier-based PWM modulation technique. The findings discussed in this article relate to output currents and output voltages fluctuations of the three-phase three-level NPC rectifier. The current harmonic from the grid is also taken into account for the NPC. The capacity voltage balance of the rectifier is also examined. In addition, efficiency and power factor calculation were made for this rectifier. The charging system outputs appear suitable for three-phase AC/DC NPC rectifier. The findings are discussed in the literature for rectifiers also evaluated for electric vehicle charging and other applications as in [5], [9] and [24].

This paper is organized as follows: Section 2 describes the general structure of the system, circuit topology, modulation technique and its design calculation together with the control method. The findings are described in Section 3 and finally the paper is concluded with the discussion of the results in Section 4.

2 System description and control algorithm

The 3L-NPC rectifier has high power factor and provides a suitable solution to improve power quality at high voltages. DC chargers evaluated with this rectifier can show negligible harmonic current, small ripple factor in load voltage and load current [25]. This topology, known as bi-directional converter, is evaluated in the AC/DC side for EV charging in this study. In this section, the modulation technique and the control method of the rectifier are given together with the basic equations. System parameters were determined with the equations and analyzed by simulation studies. The 3L-NPC rectifier circuit is shown in Figure 2.

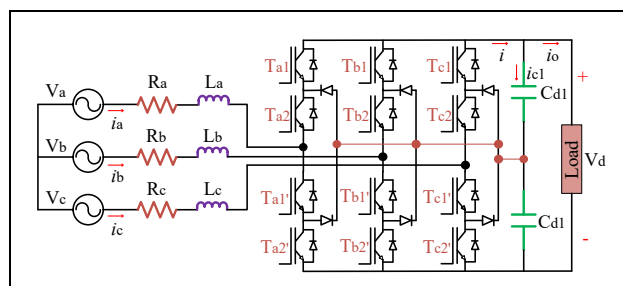

Figure 2. 3L-NPC PFC rectifier.

In this topology, each switch voltage is half DC bus voltage instead of the full DC bus voltage. Therefore, in high voltage applications, there is less voltage stress on the switches. This reduces the switching losses. According to [13], Table 1 shows comparison of the rectifiers used for DC fast chargers. NPC rectifier has less THD, and higher power factor compared to other topologies. Therefore, this topology has been studied in detail. Because the NPC rectifier appears to be promising.

Table 1. Comparison of AC/DC rectifiers for fast chargers.

Rectifiers	Switches/ Diodes	THD	Power Factor	Control Complexity
PWM [26]	6/0	Low	Wide	Low
NPC [17]	12/6	Very low	Wide	Moderate
Vienna [27]	6/6	Very low	Limited	Moderate
Buck Type [28]	6/6	Low	Limited	Low

In this rectifier, the input terminals are connected to the three-phase source through the inductance L. The rectifier input terminal voltages are V_a, V_b and V_c . The voltage vector equation can be written as Equation 1 and 2. The source voltage vector V is oriented on the d-axis. The source voltage in the rotating reference (d-q) axis can be expressed by the following equations [29].

$$v_d = L \frac{di_d}{dt} + \omega L i_q + v'_d \quad (1)$$

$$v_q = 0 = L \frac{di_q}{dt} + \omega L i_d + v'_q \quad (2)$$

Here ω is the angular frequency of the 3-phase voltage. v_d, v'_d, i_d and v_q, v'_q, i_q are current-voltage components in the d and q axes. The currents i_d and i_q are controlled by the separated voltages v'_d and v'_q . This rectifier control strategy is the same as that used in bi-level PWM rectifiers as in [28]. PI controller controls the AC-DC converter output voltage (V_{DC}). The output of this controller, $i_{d.ref}$ is used to control, i_d is the reference for the internal closed loop. The current on the q axis, i_q is controlled by a similar loop with ($i_{q.ref} = 0$) reference for high power factor, $V_{d.ref}$ and $V_{q.ref}$ reference voltage values on the d and q axes are provided by current controllers, respectively. During the d-q coordinate transformation of the three-phase input voltage, the wt angle is obtained. This angle is important for generating the switching signals on each leg of the rectifier. Appropriate modulation technique is achieved by controlling the unit sinus signals with a phase difference of 120° , taken as a reference for unipolar sinusoidal PWM signals. Table 2 shows the switching states for rectifier each leg.

Table 2. Switching states and corresponding voltages of the rectifier.

s	T_{x1}	T_{x2}	$T_{x1'}$	$T_{x2'}$	V_{xn}
1	1	1	0	0	$V_1 = V_0/2$
0	0	1	1	0	0
-1	0	0	1	1	$V_2 = -V_0/2$

There are four potential switching states for each leg of the rectifier. This situation is effective in producing the desired voltage levels at the AC terminals. Three operating modes on the A leg of the converter are shown in Figure 3.

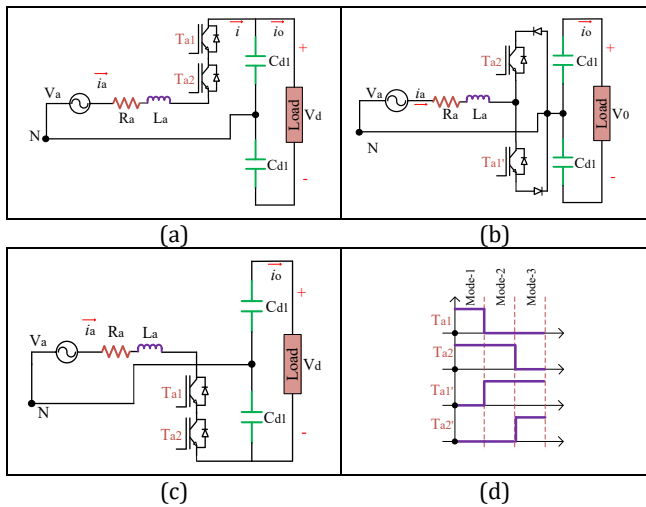

Figure 3. Three operating modes for phase A of 3L-NPC PFC rectifier.

This situation is similar for phases B and C. For example, power switches T_{a1} and T_{a2} are on for Operation mode 1. The AC terminal voltage V_a (or V_0) is equal to $\frac{V_0}{2}$ (where $V_{c1} = V_{c2}$). In this case, the i_a line current charges the DC bus capacitor C_{d1} . Figure 4 shows carrier-based SPWM signals of phase A.

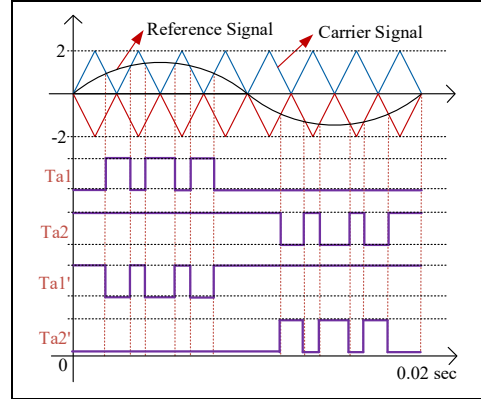
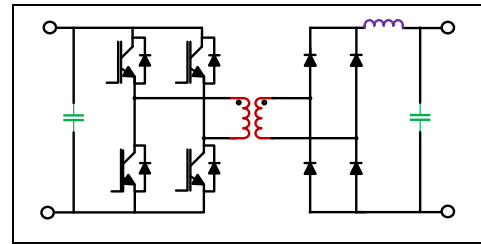
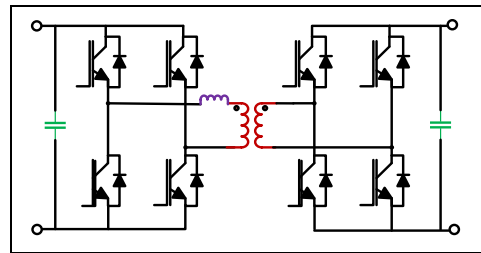

Figure 4. Proposed carrier-based SPWM strategy.

The EV fast charger was operated with NPC AC/DC rectifier followed by an isolated DC-DC converter. The rectifier has been simulated with PSFB and DAB converters separately. The PSFB and DAB converters figures are shown below as in Figure 5.



(a): PSFB DC-DC converter.



(b): DAB DC-DC converter.

Figure 5. Isolated PSFB. (a): and DAB. (b): DC-DC converter topologies

Unlike the DAB converter, the PSFB DC-DC converter has diodes on the second side that allow power to flow in single direction. PSFB is very popular for EV chargers with its simple PWM control, modularity, and low EMI features. The power flow occurs due to the change of phase between the switches on the primary side. In fact, the circulating current on the primary side can cause additional losses. A large output inductor on the secondary side can increase the cost. Since the output voltage is high in EV charger, overvoltage across the full bridge rectifier is severe. Losses of diodes are obvious disadvantages of this topology for high power flow [30]. Also, a hybrid converter consisting of PSFB converter and LLC series resonant converter is presented in [31] to increase the power density and efficiency of the conventional PSFB converter.

The DAB topology consists of a full-bridge structure with active switches on the primary and secondary sides, connected by a high-frequency transformer. DAB is a suitable converter for DC/DC power stage due to its high efficiency, isolation, and wide voltage transfer [32]. The modular nature of DAB allows it to scale to higher power levels. It can also provide bidirectional power flow. Wide voltage gain is an important factor for DAB converter in EV chargers. Wide voltage gain can be achieved in DAB [33] with a new circuit structure based on dual transformers. Dual outputs cascade due to dual mode (primary side and secondary side phase shift) control, securing a very wide output range. However, the efficiency of the converter may decrease as the extra inductor includes [34].

2.1 Determination of the system parameters

Determining the values of the boost inductance and the DC bus capacitances in the rectifier part is very important for charging system parameters. These values are determined assuming the AC source voltage is sinusoidal form, the converter switches are lossless, and the AC/DC and DC-DC PWM converters are operating in linear modulation mode.

The AC-DC converter is designed for 100 kW. D is calculated as 0.593 according to the system parameters. If the source current ripple max is assumed 4 %, Δi has been calculated 5 Ampere. t_{on} is the turn on time of the switch in Equation 3.

$$t_{on} = \left(\frac{1}{f_s}\right) \left(\frac{V_0 + V_F - v_s}{V_0}\right) \quad (3)$$

In this formula, VF is the voltage drop across the antiparallel connected diode. Voltage drop on the first diode in phase A is 400 Volt and t_{on} is 0.33×10^{-4} . L is 2.15 mH according to Equation 4 and t_{off} has been calculated as 0.23×10^{-4} in Equation 5.

$$L = \frac{1}{\Delta i_s} v_s t_{on} \quad (4)$$

$$t_{off} = \frac{L \Delta i_s}{V_0 - |v_s|} v_s t_{on} \quad (5)$$

DC charger gives low current harmonic with $L=2.15$ mH. The % THD is below the recommended limit by the IEEE 519 Standards. It is seen in Figure 6.

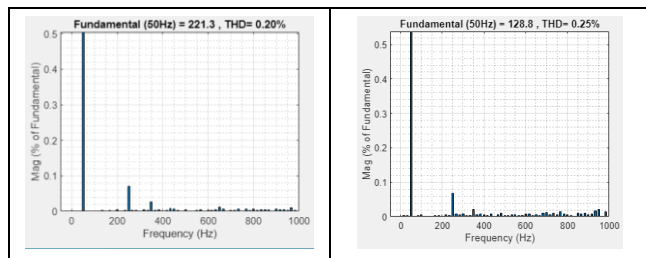

(a): With DAB.

(b): With PSFB.

Figure 6. Harmonic spectrum of phase A current.

The filter design for the rectifier, which is considered for evaluation at the fast-charging station, was found by equations 3, 4 and 5. In the fast-charging system proposed in [35], the voltage falling on the switches is quite high and therefore switching losses reduce the efficiency of the system. In this study, the stresses on the switches are reduced thanks to the neutral point clamped system. In [36], ripple minimization was

performed by controlling two cascade DAB together with NPC rectifier, but there is no need for extra circuitry for ripple minimization in this study. After determining the optimum parameters for the NPC circuit, comprehensive results for fast charging are presented.

Table 3 shows V_{DC} ripples (ΔV_0) for different capacitance values. Figure 7 shows the capacity balance for both DC-DC converters. When the DC charger is designed with a PSFB converter, there is a ripple of about 20 V for the 800 Volt DC output voltage. For the DAB converter, there is a ripple of about 10 V. This fluctuation is around 2.5% and 1.75% for both chargers.

Table 3. ΔV_0 (%) for different capacitance values with two different isolated DC-DC converters

C_{d1}, C_{d2} (μF)	ΔV_0 (V%) – PSFB	ΔV_0 (V%) – DAB
1000	42	42
1500	22	24
2000	19	16
2500	17.6	10.8
3000	10.2	9.6
3500	7.1	7
4000	5	4.5
4500	3.5	3.5
5200	2.5	1.75
5500	2.6	1.75
1000	42	42
1500	22	24

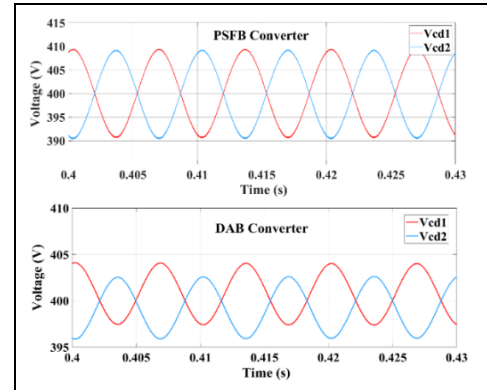

Figure 7. The capacitor C_{d1} and C_{d2} voltage waveforms for both converters.

The C_{d1} and C_{d2} capacitance values were taken as 5200 μF by looking at Table 2, and simulation studies were carried out. Table 4 presents the system parameters determined with the calculations.

Table 4. System parameters in the simulation.

Supply-side parameters	Load-side parameters
220 V, 50 Hz	DAB and PSFB Converter
$L=2.15$ mH, $R=0.1 \Omega$	$C_{d1} = C_{d2} = 5200 \mu F$
Reference DC Voltage: $V_{DC,ref} = 800$ V	Switching Frequency: $f_s = 33$ kHz

3 Simulation studies and performance evaluation

Three-phase AC/DC 3L-NPC PFC rectifier analysis is evaluated together with PSFB converter and DAB converter. Simulation studies show the validity and flexibility of the three-phase AC-DC 3L-NPC PFC rectifier for DC charging electric vehicles.

In this study, a Lithium-Ion battery type with 400 volts nominal voltage and 250 Ah rated has been used. Different loading conditions are determined according to the charge rate of the battery. Since the drawn current varies depending on the charge rate of the battery, the power of the charger also changes in direct proportion to the current charging the battery.

Figure 8 shows block diagram of the power circuit, control scheme and isolated DC-DC converters connected to the power grid. The Simulink model is presented in detail in Figure 8. According to Figure 8, phase voltages and phase currents are controlled by rotating them to the dq axis as in [37]. Thanks to the phase-locked loop (PLL), the control algorithm ensures so that the voltage phase angle and current phases are the same. The sinus signals, which are the reference for the switching signals, can thus be checked. According to Figure 8, the $V_{c1}+V_{c2}$ capacitance total voltage at the NPC rectifier output and the reference V_{DC} voltage difference passes through the controller to provide the capacitance balance. Accordingly, PWM control is implemented, and capacity balance is provided.

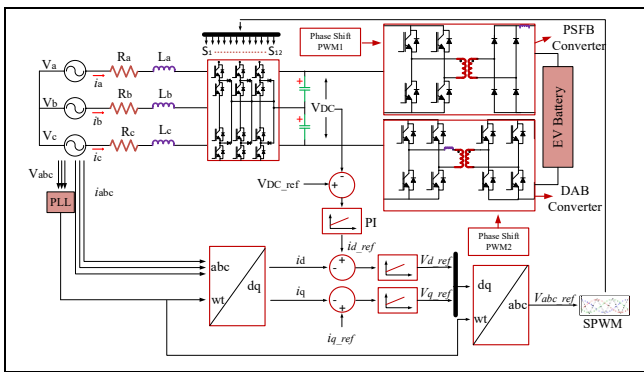

Figure 8. The overall design of the system.

Three voltage levels are obtained due to the switching states at the AC terminals of the 3L-NPC PFC rectifier as shown in Figure 9, rectifier input terminal voltage V_{an} , and current waveforms for PSFB and DAB converters are shown.

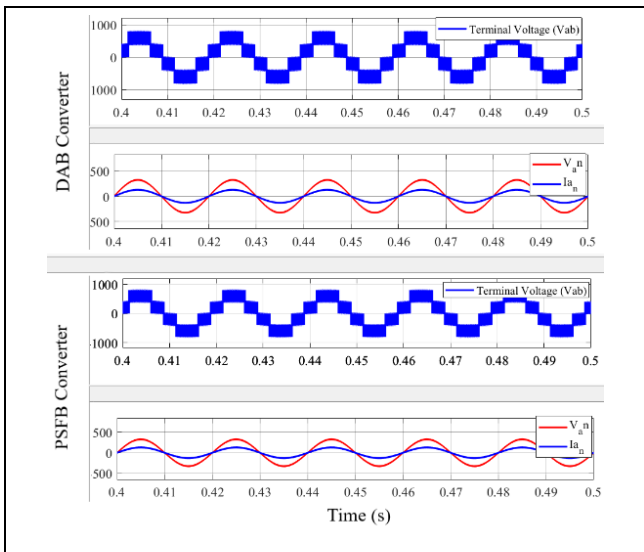

Figure 9. Rectifier input terminal voltage (V_{an}) and grid current (I_{an}) for PSFB and DAB converters.

Figure 10 shows the power factor-load graph for PSFB and DAB. The power factor is more than 0.98 for both DC-DC converters under different loading conditions.

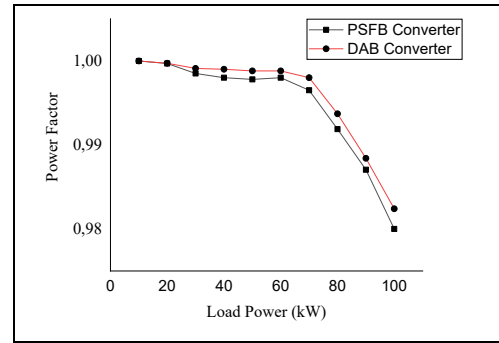

Figure 10. The input power factor with the variation of load power for both converters.

The rectifier efficiency decreases as the load power increases as shown in Figure 11. 3L-NPC PFC rectifier shows better efficiency for DAB converter.

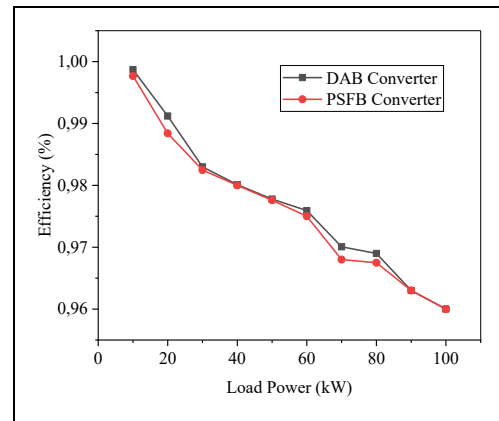

Figure 11. The rectifier efficiency variation with load power.

Figure 12 shows the THD- $f_{switching}$ graph with DAB and PSFB converters. While the rectifier switching frequency is about 33 kHz, the charger has the lowest THD even in different loading conditions.

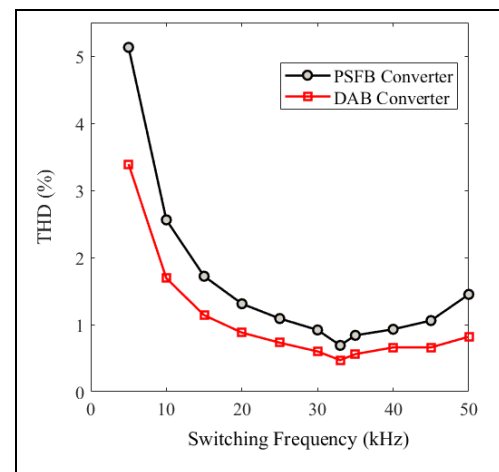

Figure 12. The input current THD corresponding to the switching frequency.

Figure 13 shows the rectifier output voltage-current graphs when the system is at 100 kW. The voltage ripple is below 0.5% for 800 Volt DC voltage. The current ripple is below 0.1% for 125 Ampere DC current.

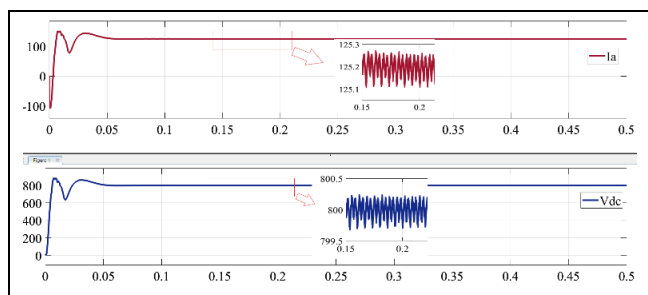

Figure 13. Ripples (%) of 800 Volt and 125 Ampere for DAB converter.

4 Conclusion

In this study, 100 kW 3L-NPC PFC rectifier has been evaluated for DC chargers of electric vehicles. This rectifier is simulated with two different isolated DC-DC converters. These isolated converters are PSFB and DAB converter which are used for dc fast chargers. According to the simulation results, the THD of input current varies between 0.19% and 5% under different load conditions. The converter switching frequency was estimated as 33 kHz by considering the input current harmonics. The power factor is between 0.995 and 1. 800 Volt rectifier DC output voltage ripple and 125 Ampere DC output current ripple have been investigated. The DC output voltage ripple and DC current ripple are less than 1%. These two different DC chargers perform well at high power levels without an extra PFC circuit and the 3L-NPC PFC rectifier efficiency is over 96%. These results show that the proposed rectifier is valid and flexible for EV DC charging systems.

5 Acknowledgement

The authors gratefully thank the Scientific and Technological Research Council of Turkey (TUBITAK), which supported Merve MOLLAHASANOGLU financially within the scope of 1002 Short-Term R&D Funding Program (Project Number 123E050).

6 Author contribution statements

In the scope of this study, Merve MOLLAHASANOGLU contributed to the formation of the idea, literature review, obtained the simulation results, data analysis and writing the paper. Hakki MOLLAHASANOGLU contributed to analyses of results, and finally Halil Ibrahim OKUMUS contributed writing and revision of the article.

7 Ethics committee approval and conflict of interest statement

"There is no need to obtain an ethics committee approval for the article prepared".

"There is no conflict of interest with any person / institution in the article prepared".

8 References

- [1] Metwly MY, Abdel-Majeed MS, Abdel-Khalik AS, Hamdy RA, Hamad MS, Ahmed S. "A review of integrated on-board EV battery chargers: Advanced topologies, recent developments and optimal selection of FSCW slot/pole combination". *IEEE Access*, 8, 85216-85242, 2020.
- [2] Sam CA, Jegathesan V. "Bidirectional integrated on-board chargers for electric vehicles-A review". *Sādhanā*, 46(26), 1-14, 2021.
- [3] Monteiro V, Afonso J, Sousa T, Afonso JL. *The Role of off-Board Ev Battery Chargers in Smart Homes and Smart Grids: Operation With Renewables and Energy Storage Systems*. Editors: Ali A, Behnam MI, Ali E. The Role of off-Board EV Battery Chargers in Smart Homes and Smart Grids: Operation with Renewables and Energy Storage Systems, 47-72, Cham, Switzerland, Springer Nature Switzerland AG, 2020.
- [4] Mollahasanoglu M, Okumus H. "A review of three phase AC-DC power factor correction converters for electric vehicle fast charging". *European Journal of Science and Technology*, 32, 663-669, 2021.
- [5] Piasecki S, Zaleski J, Jasinski M, Bachman S, Turzyński M. "Analysis of AC/DC/DC converter modules for direct current fast-charging applications". *Energies*, 14(19), 6369, 2021.
- [6] Ozkop E, Altas IH, Sharaf AM. "A novel switched power filter-green plug (SPF-GP) scheme for wave energy systems". *Renewable energy*, 44, 340-358, 2012.
- [7] Antoniewicz K, Jasinski M, Kazmierkowski MP, Malinowski M. "Model predictive control for three-level four-leg flying capacitor converter operating as shunt active power filter". *IEEE Transactions on Industrial Electronics*, 63(8), 5255-5262, 2016.
- [8] Rivera S, Wu B, Kouro S, Yaramasu V, Wang J. "Electric vehicle charging station using a neutral point clamped converter with bipolar DC bus". *IEEE Transactions on Industrial Electronics*, 62(4), 1999-2009, 2014.
- [9] Safayatullah M, Elrais MT, Ghosh S, Rezaei R, Batarseh I. "A comprehensive review of power converter topologies and control methods for electric vehicle fast charging applications". *IEEE Access*, 10, 40753-40793, 2022.
- [10] Bai H, Taylor A, Guo W, Szatmari-Voicu G, Wang N, Patterson J, Kane J. "Design of an 11 kW power factor correction and 10 kW ZVS DC/DC converter for a high-efficiency battery charger in electric vehicles". *IET Power Electronics*, 5(9), 1714-1722, 2012.
- [11] Kesler M, Kisacikoglu MC, Tolbert LM. "Vehicle-to-grid reactive power operation using plug-in electric vehicle bidirectional offboard charger". *IEEE Transactions on Industrial Electronics*, 61(12), 6778-6784, 2014.
- [12] Çetin S. "High efficiency design approach of a LLC resonant converter for on-board electrical vehicle battery charge applications". *Pamukkale University Journal of Engineering Sciences*, 23(2), 103-111, 2017.
- [13] Tu H, Feng H, Srdic S, Lukic S. "Extreme fast charging of electric vehicles: a technology overview". *IEEE Transactions on Transportation Electrification*, 5(4), 861-878, 2019.
- [14] Jayakumar V, Chokkalingam B, Munda JL. "A comprehensive review on space vector modulation techniques for neutral point clamped multi-level inverters". *IEEE Access*, 9, 112104-112144, 2021.
- [15] Ozkop E, Altas IH. "Control, power and electrical components in wave energy conversion systems: a review of the technologies". *Renewable and Sustainable Energy Reviews*, 67, 106-115, 2017.
- [16] Ellis RG. "Harmonic analysis of industrial power systems". *IEEE Transactions on Industry Applications*, 32(2), 417-421, 1996.

- [17] Tan L, Wu B, Yaramasu V, Rivera S, Guo X. "Effective voltage balance control for bipolar-DC-bus-fed EV charging station with three-level DC-DC fast charger". *IEEE Transactions on Industrial Electronics*, 63(7), 4031-4041, 2016.
- [18] Kang T, Kim C, Suh Y, Park H, Kang B, Kim D. "A design and control of bi-directional non-isolated DC-DC converter for rapid electric vehicle charging system". *Seventh Annual IEEE Applied Power Electronics Conference and Exposition (APEEC)*, Orlando, FL, USA, 05-09 February 2012.
- [19] Montero-Robina P, Albea C, Gómez-Estern F, Gordillo F. "Hybrid modeling and control of three-level NPC rectifiers". *Control Engineering Practice*, 130, 1-13, 2023.
- [20] Abarzadeh M, Khan WA, Weise N, Al-Haddad K, El-Refai, AM. "A new configuration of paralleled modular anpc multilevel converter controlled by an improved modulation method for 1 mhz, 1 mw ev charger". *IEEE Transactions on Industry Applications*, 57(3), 3164-3178, 2020.
- [21] Pulikanti SR, Konstantinou G, Agelidis VG. "Hybrid seven-level cascaded active neutral-point-clamped-based multilevel converter under SHE-PWM". *IEEE Transactions on Industrial Electronics*, 60(11), 4794-4804, 2012.
- [22] Srdic S, Lukic S. "Toward extreme fast charging: Challenges and opportunities in directly connecting to medium-voltage line". *IEEE Electrification Magazine*, 7(1), 22-31, 2019.
- [23] Yüksel A, Özkop E. "Control of single phase grid connected transformerless PV inverter system". *Pamukkale University Journal of Engineering Sciences*, 25(2), 143-150, 2019.
- [24] Saadaoui A, Ouassaid M, Maaroufi M. "Overview of integration of power electronic topologies and advanced control techniques of ultra-fast EV charging stations in standalone microgrids". *Energies*, 6(3), 1-21, 2023.
- [25] Sharma D, Bhat AH, Ahmad A, Langer N. "Capacitor voltage balancing in neutral-point clamped rectifier using modified modulation index technique". *Computers & Electrical Engineering*, 70, 137-150, 2018.
- [26] Deb N, Singh R, Brooks RR, Bai K. "A review of extremely fast charging stations for electric vehicles". *Energies*, 14(22), 1-27, 2021.
- [27] Rajendran G, Vaithilingam CA, Misron N, Naidu K, Ahmed, MR. "Voltage oriented controller based vienna rectifier for electric vehicle charging stations". *IEEE Access*, 9, 50798-50809, 2021.
- [28] Mallik A, Khaligh A. "Comparative study of three-phase buck, boost and buck-boost rectifier topologies for regulated transformer rectifier units". *IEEE Transportation Electrification Conference and Expo (ITEC)*, Dearborn, MI, USA, 14-17 June 2015.
- [29] Saleh SA, Ozkop E, St-Onge XF, Richard C. "Testing the Performance of a dq0 Phaselet Transform Based Digital Differential Protection for 3 ϕ Converter Transformers". *IEEE Transactions on Industry Applications*, 56(6), 6258-6271, 2020.
- [30] Mishima T, Akamatsu K, Nakaoka M. "A high frequency-link secondary-side phase-shifted full-range soft-switching PWM DC-DC converter with ZCS active rectifier for EV battery chargers". *IEEE Transactions on Power Electronics*, 28(12), 5758-5773, 2013.
- [31] Kim JH, Lee IO, Moon GW. "Analysis and design of a hybrid-type converter for optimal conversion efficiency in electric vehicle chargers". *IEEE Transactions on Industrial Electronics*, 64(4), 2789-2800, 2017.
- [32] De-Doncker RW, Divan DM, Kheraluwala MH. "A three-phase soft-switched high-power-density DC/DC converter for high-power-applications". *IEEE Transactions on Industry Applications*, 27(1), 63-73, 1991.
- [33] Shi K, Zhang D, Zhou Z, Zhang M, Zhang D, Gu Y. "A novel phase-shift-dual-full-bridge converter with full soft-switching range and wide conversion range". *IEEE Transactions on Power Electronics*, 31(11), 7747-7760, 2016.
- [34] Xiao H, Xie S. "A ZVS bidirectional DC-DC converter with phase-shift plus PWM control scheme". *IEEE Transactions on Power Electronics*, 23(2), 813-823, 2008.
- [35] Monteiro V, Ferreira JC, Melendez AAN, Couto C, Afonso JL. "Experimental validation of a novel architecture based on a dual-stage converter for off-board fast battery chargers of electric vehicles". *IEEE Transactions on Vehicular Technology*, 67(2), 1000-1011, 2017.
- [36] Mortezaei A, Abdul-Hak M, Simoes MG. "A bidirectional NPC-based level 3 EV charging system with added active filter functionality in smart grid applications". *In 2018 IEEE Transportation Electrification Conference and Expo (ITEC)*, Long Beach, CA, USA, 13-15 June 2018.
- [37] Yüksel A, Özkop E. "A single phase standalone photovoltaic system with HERIC inverter control". *In 2016 National Conference on Electrical, Electronics and Biomedical Engineering (ELECO)*, Bursa, Turkey, 01-03 December 2016.