



Available online at [www.academicpaper.org](http://www.academicpaper.org)

**Academic @ Paper**

ISSN 2146-9067

International Journal of Automotive  
Engineering and Technologies

Vol. 6, Issue 2, pp. 85 – 94, 2017

---

**International Journal of Automotive  
Engineering and Technologies**

---

<http://www.academicpaper.org/index.php/IJAET>

**Original Research Article**

## **A Novel Glow Plug Design to Improve Heating Capability via Induction Heating**

Bayram Akdemir<sup>1,\*</sup> and Bayram Volkan reisoglu<sup>2</sup>

<sup>1,2</sup> Selcuk University, Engineering Faculty, Electrical and Electronics Engineering Department, Selcuklu, Konya, TURKEY

Received 09 April 2017 Accepted 01 August 2017

---

### **Abstract**

Glow plug is a simple method to improve cold start for diesel engines, especially for cold conditions and first starting. In cold or iced weather conditions, diesel engines cannot reach the ignition temperature just compressing the air. Thus, heated air must be added to combustion chamber before the compressing via external device such as glow plug. Glow plug helps engine regulate the first starting and leads to obtain low emission during the cold starting or up to warm up the engine due to its controllability. Although glow plug installing is easy way to improve heat air obtaining, glow plugs have some limitations. Major problem, generated heat inside the glow plug starts from inside to outside. Thus, it takes time to obtain heated air. During the extremely cold weather conditions, one cycle not enough for heating. So, temperature of air is another major factor reducing the glow plug affect. On the contrary, induction heating is fast and efficient method and could be acceptable new generation method compared the resistive heating. Induction heating is based on hysteresis losses at high frequency switching. Induction heating has strong affect on iron based materials which has large hysteresis are. Our method is based on induction heating using 368 kHz switching frequency to improve heating capability. In addition to resistive heating, induction heating increases the heat volume. Moreover, induction heating effects the cover of the glow plug, thus improve method has no destructive affect on the core of glow plug because the surface heating.

**Keywords:** Glow plug, induction heating, high frequency, cold start, cold weather condition, Royer oscillator circuit.

---

\*Corresponding author:

E-mail: [bayakdemir@selcuk.edu.tr](mailto:bayakdemir@selcuk.edu.tr)

---

## 1. Introduction

Diesel engine runs without ignition plug. Compression heating during the compression fires the fuel and makes piston move down. First starting for the diesel engine is called cold start and cold start is important for diesel engine. After diesel engine warm up, engine intend to increase its revolution in per time. Idle system forced the engine at low level rpm via decreasing fuel feeding. On the contrary, for cold weather conditions, diesel engine does not intend to run easily due to low compression heating [1, 3]. In order to pass the cold start without fail, externally heated air released in to intake manifold. In addition to pre heated air, compression heating increases the pre heated air up to firing level and engine starts in safe. Glow plug is widely used in diesel engine for cold start [4, 6]. According to engine model, glow plugs could be located different places such as near the intake manifold or directly into the cylinder. Wherever glow plug inserted, its structure generally same and based on resistive heating. Resistive heating is simple and easy method and no need to external electronics components. Figure 1 shows glow plug structure.

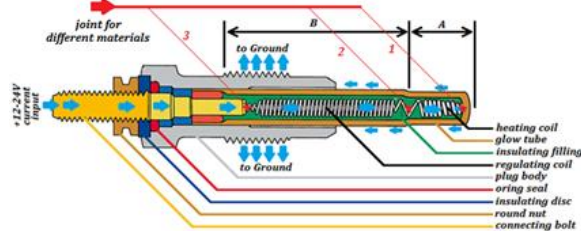

Figure 1. Glow plug structure

Glow plug runs under 12 or 24 Volt DC related to accumulator voltage level. Generally connecting bolt is connected to positive power and body is turning way for current flow. Insulating disc separates positive and ground conductive body from each others. Current flows through the regulating and heating coils and reach the body end of the heating coil. Important point is that heating coil length is shorter than regulating coil. Thus extremely heated location is "A" length. Figure 2 shows a glow plug heating capability and current flow through the time for BERU brand. As can be

seen from the graphic, the spark plug starts to heat up quickly if the glow plug is energized. According to the law of exchange of temperature with resistance, it is seen that the resistance of the system increases for a while, that is, the current drawn from the battery starts to decrease and after a while, the resistance becomes constant and the current is restricted [7,8]. So the system is spontaneously regulated. At this point, the potential problems such as overheating of the glow plug, damage to the glow plug due to overheating, rapid discharge of the battery due to overcurrent and shortening of its lifetime are eliminated.

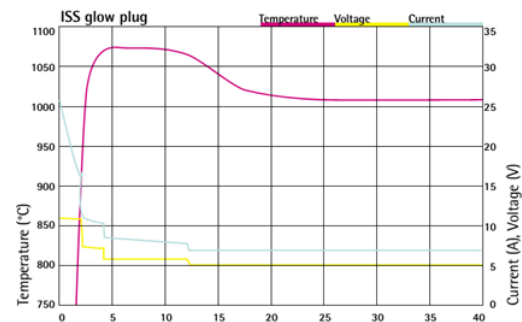

Figure 2. Glow plug heating capability and current-voltage curves related to temperature

Glow plug reaches the over the 1000 °C degrees in five seconds. After 5 seconds reachable temperature is near 1000 °C and turn to almost constant. Glow plug includes two kinds of heating coils as heater and regulator. At first, resistance of heating coil is dominant and almost all heating generating by heating coil. During the increasing the temperature, resistance of heating coil has inverse rasion between temperature and the resistance. Resistance value at target temperature can be calculated as rasion using Equ.1.

$$\frac{R_1}{R_2} = \frac{T_1}{T_2} \quad (1)$$

Where T is temperature of the resistance as Kelvin and R is ohm. According to zero temperature;

$$\frac{R}{x} = \frac{272 + 0}{272 + 1000} \quad x = 1272 R / 272$$

$$x = 4,67R$$

Execution of the Equ. 1 shows that heating resistance increase almost five times bigger

related to temperature. It is nature characteristics. On the contrary, regulating resistance increases because of the its chemical structure nearly heating element. As total, regulating and heating parts of the resistance have value sum through the heating period. Unfortunately, glow plug heats from center to outside and it takes time to reach end temperature. On the contrary, new generation glow plug has low delay time due to mechanical structure and specialized used materials. Another weak side point for the glow plug, there are 3 junctions among the materials and especially for 1 and two are face to face extremely temperature. Because of the junctions, reachable temperature level must be limited. Otherwise, thermal expansion and vaporization force the materials decompensate. Even there is in need high temperature classical resistive heating methods have limitations for glow plugs. Today, glow plug can reach over the 1000 °C temperature in 2-3 seconds.

## 2. Literature Review

### Induction heating

The most prominent advantage of induction heating (IH) is that it has high efficiency and provides fast heating of the materials [9, 10]. Induction heating is one of the most used heating technologies in many applications [11-13]. Induction heating has advantages when compared with traditional methods such as coil, fuel and resistive ovens and furnaces [14, 15]. Induction heating works through two laws of physics: magnetic hysteresis and eddy currents. [16, 17].

### Eddy current

AC current enters a coil, a magnetic field occurs around the coil related to Ampere's law as shown Equ. 2.

$$\int Hdi = Ni = f \Rightarrow \varphi = \mu HA \quad (2)$$

When a conductive material is placed in the magnetic field, it causes a change in the magnetic field density. Magnetic field's density decreases as object gets closer to center from the surface. As a result of Faraday's law, the current generates at the surface of a conductive object has an inverse

relationship to the current in the inductive circuit, as seen in Equ. 3.

$$E = \frac{d\lambda}{dt} = N \frac{d\varphi}{dt} \quad (3)$$

The electric energy that is caused by the Eddy currents comes out as a heat energy and this heat energy is calculated by Equ. 4.

$$P_e = K_e f^2 K_f^2 B_m^2 \quad (4)$$

Where,  $K_e$ , eddy current constant,  $K_f$  form konstant,  $B_m$  maximum magnetic density and  $f$  frequency and  $P_e$  is loses as watt.

The resistivity ( $\rho$ ) and permeability ( $\mu$ ) values of the conductive material determine the actual power parameter  $\delta$ . Eddy current makes the material heat. Eddy current uses surface of the materials due to frequency level. At high frequency, Eddy current cannot penetrate inside the conductive. Depth of the penetration can be explained and calculated using skin effect phenomena [18, 19]. According to related to frequency, current cannot move inside the wires or materials. Penetration of the current depth can be calculated via Equ.5. Figure 3 shows induced current and depth.

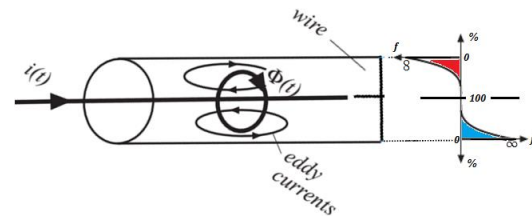

Figure 3. Eddy current and skin effect on a wire

Skin effect shows that for the high frequency, more thickness is not profitless.

$$\delta = \frac{1}{\sqrt{\pi f \rho \mu}} \quad (5)$$

Where;  $\delta$ , skin effect,  $f$ , frequency,  $\rho$ , resistivity,  $\mu$ , permeability.

### Hysteresis losses

Hysteresis losses; As a consequence of the magnetic friction, that is to say the heat energy, which is the resultant friction of the molecules in the magnetic field during their displacement due to the frequency of the frequency. Hysteresis losses occur in magnetic materials such as steel, nickel and etc. related to hysteresis lose [20,21]. While

magnetic parts are being heated, the alternating magnetic flux field causes the magnetic dipoles of the material to oscillate at flux frequency and magnetic poles change their polar orientation every cycle to follow the ac flux changing. Magnetic poles oscillating is called "hysteresis", and a amount of heat is produced due to the friction produced known as "hysteresis loses" when the dipoles oscillate. Hysteresis loses depends on integration of hysteresis curve. Figure 4 shows us to hysteresis loses.

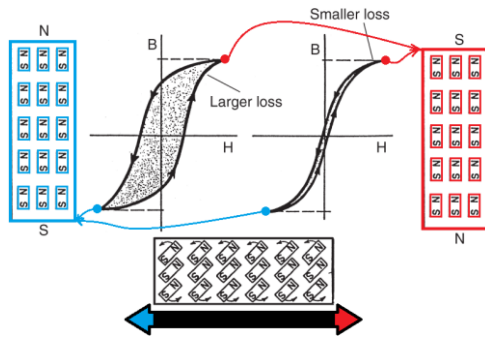

Figure 4. Hysteresis loses

Hysteresis loses is related to frequency and area of the curve. Equ. 6 shows calculation hysteresis loses.

$$P_h = \eta B_{max}^{1,6} f V \quad (6)$$

Where,  $P_h$ ; hysteresis loss (W),  $\eta$ ; hysteresis or Steinmetz's constant (J/m<sup>3</sup>), its value depends upon the nature of magnetic material,  $B_{max}$ ; maximum value of the flux density in the magnetic material (wb/m<sup>2</sup>),  $f$ ; frequency in (Hz),  $V$ ; volume of the magnetic material (m<sup>3</sup>).

#### Copper Loses

Pure load under DC or AC voltage, brings pure power related to current level and can be expressed as Equ. 7:

$$P_c = i^2 R \quad (7)$$

Where  $P_c$  is loses as watts,  $i$  is current in Ampere and  $R$  is resistor value as ohm. Cooper loses is independent from frequency [22, 23].

### 3. Materials and Method

#### Inspiration of Proposed Method

Glow plug is widely used in engines to improve emission quality during the cold weather. According to design scenario, glow plug may work up to engine warms up or just work only starting. For both situations, glow plug regulates the emission and helps engine to start in well. The proposed method based on AC power loses, copper, hysteresis and eddy current loses. Figure 5 shows different glows plugs.



Figure 5. Three kinds of glow plugs after cut the ends of the heating area

After removed the cover of the glow plugs, inside of the core can be seen and is made up rounded wire. In fact, wire includes two kinds of wires to regulate the total resistance and obtain the heating. Without cover glow plug has little inductance as expected. But, after the sealed, Table 1 shows the inductance with and without cover. Inductance value changes dramatically when compared the nude one. Not only inductance, resistance and capacitance of the glow plug were measured and listed at Table 1 to create AC and DC equivalent circuit of any glow plug. From Table 1, affect of the body cover can be obtained easily. Especially, increasing of inductance is one of major inspirations of this study. Conventional method offers a DC voltage to run. From Fig. 4, under DC voltage, inductances disappear and capacitor effect can be ignored. Inductance, under DC running just determines rise time of the current. Rise time is a nature limit of the glow plug. Calculated and separated parameters of glow plugs are listed Table 2.

**Table 1.** Inductance and resistance with and without cover for different glow plugs

Brand	Inductance		Resistance		Capacitance
	Without cover ( $L_1+L_2$ ) $\mu$ H	With cover ( $L_T$ ) $\mu$ H	Without cover ( $R_1+R_2$ ) $\Omega$	With cover ( $R_T$ ) $\Omega$	With cover ( $C_T$ ) pf
BOSCH	1,8	1500	0,51	0,67	120,5
RESCAL	0,7	20000	0,60	0,80	40
SVAC	1,2	60000	0,53	1	29-34



**Table 2.** Inductance, resistance and capacitance of inside and body for different glow plugs

Brand	Inductance		Resistance		Capacitance	Rise time
	Inside of GP ( $L_1+L_2$ ) $\mu\text{H}$	Body of GP ( $L_c$ ) $\mu\text{H}$	Inside of GP ( $R_1+R_2$ ) $\Omega$	Body of GP ( $R_c$ ) $\Omega$	With cover ( $C_T$ ) pf	mSec
BOSCH	1,8	1498	0,51	0,16	120,5	2,23
RESCAL	0,7	19999	0,60	0,20	40	25
SVAC	1,2	59999	0,53	0,47	29-34	60

For example, for the SVAC brand glow plug, even if we applied maximum running voltage to obtain high speed heating we cannot reach the time under 60 millisecond due to natural current response. On the contrary, 60 millisecond can be negligible for real application because of the waiting time for heating. Figure 6 shows AC and DC equivalent of the glow plug.

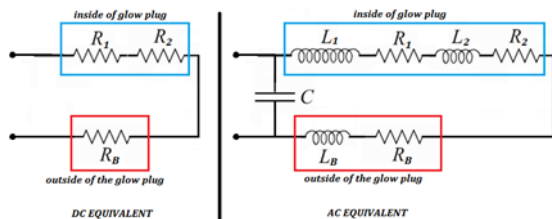

Figure 6. Equivalent of glow plug

Aim of glow plug generates much heating in front of the intake manifold to help engine start. Under DC voltage, glow plug behaves as resistor and only copper losses can be calculated using  $I^2R$ . On the contrary, under AC equivalent circuit, hysteresis, eddy and copper losses can be calculated together. All losses cause heating. Thus, under AC running, hysteresis and eddy losses must be added to present DC heating capability. This is second inspiration of the study to design electronically controlled glow plug. It is solid real that, all kinds of glow plugs start heating from inside to outside. Center has higher temperature and needs time to heat transfer. Thus, the difference in delay between the cooling of the glow plug core and the cooling time of the glow plug during cooling is due to this [24]. Figure 7 shows us that the temperature is higher in the core of the glow plug, as the example shows that in a glow plug, the cooling from the center is faster than going to the surface.

It can be realized related to insulation material between heating element and body cover such as magnesium oxide and may

reduce the thickness of the body [25]. According to AC equivalent circuit of glow plug, most of the losses have occurred at body because the eddy and hysteresis losses. This is third inspiration of this study. Heated body reduces the time for heat transfer and waiting time.

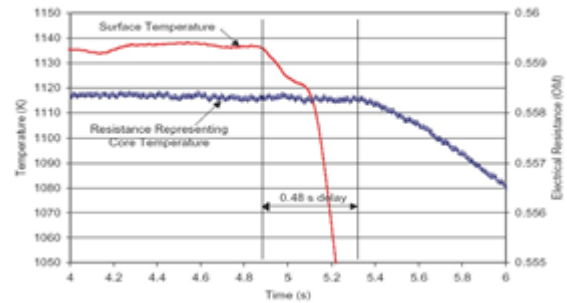

Figure 7. Temperature delay from glow plug surface to core

### Design of The Induction Heating For Glow Plug

Induction heating (IH) is widely used for heating or melting. Related to materials, hysteresis and eddy current losses have different proportion. But, all losses help increasing the heating. It is possible to design different induction heating circuits for glow plug. But it is not possible to isolate the glow body from the screwed place. Proposed circuit designed as common point inductance structure to obtain high power density. In order to obtain high heating capability isolated body structure can be realized and used in this study.

Proposed method based on a high speed capability Mosfet to reduce switching losses. Figure 8 shows the proposed circuit diagram. Induction heating frequency was used above 300 kHz and run under 24 Volt power supply and 368 kHz running frequency measured. Although Mosfets are generally designed around 20-50 kHz determined frequency to obtain low power loss, in this application

mosfet used at high frequency to generate high power hysteresis and eddy current losses on the glow plug body surface [26]. Thus, for the test circuit MOSFET IRFP250N was used to switch the inductor pairs.

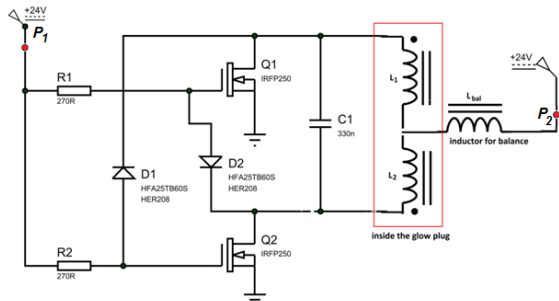

Figure 8. Designed induction heating circuit for glow plug

### The Working Principle of the Circuit

The designed circuit is a simple oscillator circuit due to its self-operation advantages and is known as the collector Royer oscillator circuit.

In any time only  $Q_1$  or  $Q_2$  open and both MOSFETs cannot be on at same time. When  $Q_1$  is on,  $Q_2$  is closed via  $D_1$ . But produced voltage output on the non-switched coil  $L_2$  generates a reverse voltage that makes stops the  $Q_1$  via making the gate voltage much negative than the zero volt. Thus, conducted  $Q_1$  immediately runs away from one side. After  $Q_1$  stops,  $Q_2$  obtains the gate voltages from  $R_2$  and turn on. Same event begin for and vice versa behaviors starts for  $Q_2$ . MOSFETs are opened and closed one by one and fundamental frequency are determined by  $L_1$ ,  $L_2$ ,  $L_{balance}$  and  $C_1$  and  $R$ .

The fact that the load coil is 3-point instead of 2, the need for a common one seems to be the main disadvantage of this circuit. The center tapped coil is necessary for the two N-type Mosfets to be able to drive the AC field through the DC supply. The common point of the coil is connected to the DC supply, and both points of the coil are connected to the Mosfets, alternatively flowing back and forth in both directions. The newly designed glow plug appears in Figure 9.

The current drawn by the glow plug will vary according to the type and dimensions of the material around the resistors.

When we look at the electrical circuit, we see

that it is not very complicated. With such a circuit, the design of the glow plug is very easy and does not require much material. The both of resistors are 270 ohm, 2W. Resistance values should be selected at a small value because they will determine how quickly the Mosfets can be opened. When opposed MOSFETs are opened, the resistor must not be chosen too small because it will be pulled to the ground via the diode [27].



Figure 9. The center tapped coil to simulate glow plug

Diodes are used to drain the Mosfet gates. The diodes must be selected with low forward voltage drop because one of the MOSFETs is open while the other is completely closed. HER208 diodes are known as high efficiency diodes and have features such as high speed, low voltage drop. The voltage resistance of the diodes must be resistant to the voltage rise at the resonance of the electrical circuit. The Mosfet is used 200V 30A (IRFP250N). These MOSFETs were chosen because they have low drain-source resistance and fast response times. The  $L_{bal}$  inductor is used to limit the current drawn and to keep the possible high frequency oscillations away from the power supply. So the inductance value was chosen quite large (we used 2.1mH). In addition, it must be made of thick iron so as not to be influenced by flow current. If there is a frequency oscillation, the circuit may not resonate. The shock inductance we used was formed by winding 14 turns of the magnet wire with a thickness of 1.2 mm, as seen in Figure 10.

We did not use PCBs because there are very few electronic items and high current at the time and we soldered the materials directly on the cooler because they would be heated. We used thick wire to avoid problems in high

currents. Figure 11 shows implemented whole circuit



Figure 10. The shock inductor

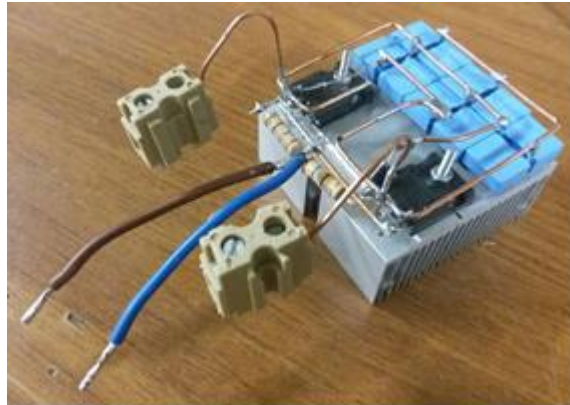

Figure 11. The induction heating circuit for glow plug

$C_1$  capacitor and  $(L_1 + L_2)$  inductances constitute the resonance circuit of the glow plug. Selected materials must be able to withstand high temperatures and currents. As a capacitor we used 330 nF capacitors in parallel with 10 units of 33nF capacitors.

#### 4. Results

The coils are made of thick coils so that the current will flow in large amounts.

The coil and the capacitor must be connected in parallel to form a resonance circuit. The coil and capacitor will have a specific resonance frequency at which the circuit can operate automatically. The coil and capacitor circuit we used here can resonate at about 200 kHz. The resonance frequency can be calculated using Equ. 8.

$$f_c = \frac{1}{2\pi\sqrt{LC}} \quad (8)$$

Where,  $C_1=330$  nF and  $L_1 = L_2 = 2$   $\mu$ H. Resonance frequency was calculated as 196 kHz. The frequency value measured at the oscilloscope is 368 kHz.

The capacitors must be resistant to large currents and heat, otherwise they will be damaged and cause the circuit to fail. Also,

most of the current needs to be placed close to the glow plug because it will flow between the glow plug and the capacitor. The wires between the glow plug and the capacitor should be selected thicker, but thinner wires can be used if desired for control part of the circuit.

Figure 12.a shows measured frequency signals on the gate terminals. Measured frequency is 368 kHz between gate and source pins of both of MOSFETs. Figure 12.b shows Drain voltages of MOSFETs without energized of the coil. Fig. 12a and Fig. 12b are related to standby situation. Under the standby, there is no power on glow plug connection at P<sub>1</sub> point but power is available on P<sub>2</sub> point (Figure 8).

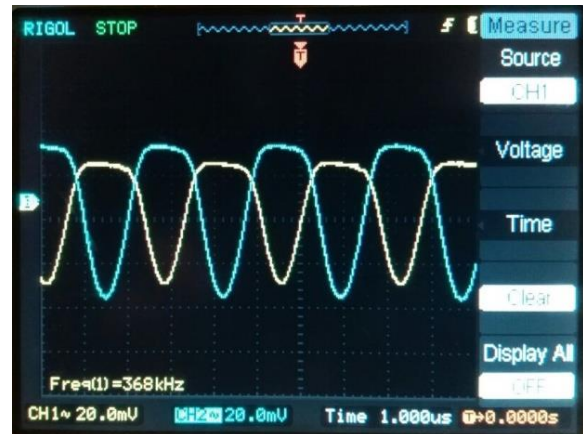

Figure 12.a Voltage values for gate signals (under standby)

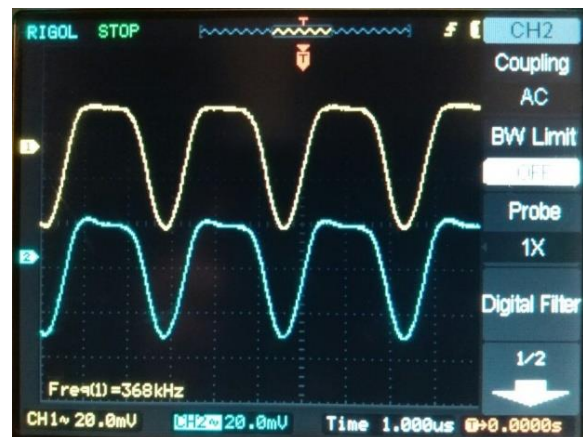

Figure 12.b Drain voltages for MOSFETs (under standby)

After the circuit is energized, the circuit enters into self-oscillation and the glow plug warmed up quickly. Figure 13.a shows the oscilloscope signals at the gate terminals of both MOSFETs and Figure 13.b shows the



oscilloscope signals at the drain terminals of both MOSFETs.



Figure 13.a Gate signals of MOSFETs under energized



Figure 13.b Drain voltages on MOSFETs during the running

Approximately 4 seconds after the power section of the electric circuit is energized, the glow plug is reddish. Figure 14 shows glow plug as turned reddish. Temperature was measured as 549 °C.



Figure 14. The latest state of the glow plug

## 5. Evaluation of the Results

In this study, a novel structure glow plug model was tested and compared the two conventional models to present the possible benefits. on the contrary aim of the study is to show possibility of induction heating abilities on glow plug running. Table 3 shows a conventional brand (Vespa-24V) abilities to refere. From the Table 3, Tested model six

grams. on the contrary, conventional model is only one-gram mass to be heated. In order to obtain real comparison mass value is normalized using heating equation. Equ 9 shows heating capability related to temperature and mass. For first and normalized conditions only changes the mass from 6 grams to one gram to make normalization.

$$Q = mc\Delta t \quad (9)$$

where, m is mass, c is specific heat capacity and t is changes in temperature. Figure 15 shows the temperatures of the glow plugs in time axis. the purple one is normalized of studied glow plug.

Table 3. Features of vespa brand and studied glow plugs

	Vespa	Studied Model
Diameter, mm	5	8
Thickness, mm	0.5	0.5
Temperature, °C)	579	549
Mass, gr	1	6
Length, mm	18	73

From Figure 15, recorded temperatures values for the Vespa brand and studied glow plugs are drawn as graph. Green one is studied model that has a slow heating capability due to big mass. Red one is Vespa and it is commercial model. moreover, its characteristics is aim of the study to reach. vespa has 1-gram weight which is targeted to be heated. on the contrary, studied model has 6 grams weight and in order to compare the results, pruple colored graph realized according to 1 gram weight.

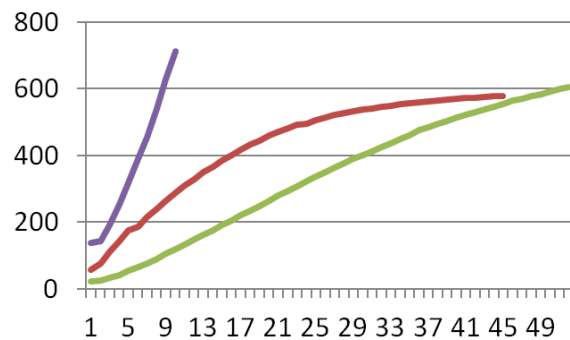

Figure 15. Graphics for Vespa brand (red), studied glow plug (green) and normalised values for studied glow plug (purple).

In order to evaluate the results, obtained



results are normalized because of the physical differences. Especially total mass of the body is normalized because the difference weights. After the normalization, Induction heated based glow plug structure has fast heating capability than the Vespa brand model. This is just comparing not a competition between the glow plugs. Any commercial model is targeted by this study to evaluate the obtained results. Vespa has been chosen to compare the results.

## 6. Conclusion

In this study, A novel glow plug structure merged with induction heating discussed and implemented. Glow plug is a simple way to improve diesel engine combustions especially under cold weather conditions. During the first start of any diesel engine spews out harmful gases. Fortunately, glow plug reduces harmful gases and leads to obtain better combustion quality.

Induction heating; it is widely used for various heat treatments such as melting, welding, soldering, hot forming, tempering, surface hardening. Induction heating can be directional by the coil according to form of the materials. Induction heating has many advantages such as heating target surface or place and moreover could be arrange the heating deep related to frequency. In this study, induction heating and proposed glow plug was merged to observe induction heating benefits. Because of the frequency, glow plug surface was much igneous than the inside. Temperature was measured 549<sup>0</sup>C after 45 seconds running for six grams body weight and 73mm body length. Normalized results show that for the one gram weight induction heated based glow plug dramatically could be faster than the conventional ones. This study encourages us to improve glow plug structure according to induction heating necessities to improve heating capability and obtain high flexibility under hard conditions.

## 7. References

[1] Benson, Rowland S., and Norman Dan Whitehouse. Internal combustion engines: a

detailed introduction to the thermodynamics of spark and compression ignition engines, their design and development. Vol. 1. Elsevier, 2013.

[2] Labeckas, Gvidonas, and Stasys Slavinskis. "The effect of rapeseed oil methyl ester on direct injection diesel engine performance and exhaust emissions." *Energy Conversion and Management* 47.13 (2006): 1954-1967.

[3] Endiz, M.S., Özcan M., et al." The simulation and production of glow plugs based on thermal modeling", *Turk J Elec Eng & Comp Sci*, vol. 23, pp. 2197-2207, 2015.

[4] Payri, F., et al. "Investigation of Diesel combustion using multiple injection strategies for idling after cold start of passenger-car engines." *Experimental Thermal and Fluid Science* 34.7 (2010): 857-865.

[5] Weidmann, Kurt, and Holger Menrad. Fleet test, performance and emissions of diesel engines using different alcohol-diesel fuel blends. No. 841331. SAE Technical Paper, 1984.

[6] Özcan M., Endiz M. S, et al, "A new approach to the glow plugs manufacturing for diesel engines using thermal circuit simulations", 2nd International Conference on Aeronautical, Robotics and Manufacturing Engineering (ARME'2015), Dec. 3-4, 2015, Antalya, Turkey.

[7] Gotoh, Shunsuke, et al. "Controller and glow plug for controlling energization modes." U.S. Patent No. 7,319,208. 15 Jan. 2008.

[8] Li, Bob X., and Brian K. Allston. "Method for controlling glow plug ignition in a preheater of a hydrocarbon reformer." U.S. Patent No. 8,183,501. 22 May 2012.

[9] M. G. Lozinskii, *Industrial Applications of Induction Heating*, [1st English ed. Oxford, New York,: Pergamon Press, 1969.

[10] W. C. Moreland, "The induction range: its performance and its development problems," *IEEE Transactions on Industry Applications*, vol. 9, no. 1, pp. 81-85, Jan./Feb. 1973.

[11] P. R. Stauffer, T. C. Cetas, and R. C. Jones, "Magnetic Induction Heating of

- Ferromagnetic Implants for Inducing Localized Hyperthermia in Deep-Seated Tumors," *IEEE Transactions on Biomedical Engineering*, vol. BME-31, no. 2, pp. 235-251, February 1984.
- [12] G. H. Brown, C. N. Hoyler, and R. A. Bierwirth, *Theory and Application of Radio-Frequency Heating*. New York,: Van Nostrand, 1947.
- [13] J. W. Cable, *Induction and Dielectric Heating*. New York,: Reinhold, 1954.
- [14] V. Rudnev, D. Loveless, R. Cook, and M. Black, *Handbook of induction heating*. New York: Marcel Dekker Inc., 2003.
- [15] J. Davies, *Conduction and Induction heating*. London: Peter Peregrinus Ltd., 1990.
- [16] A. Mühlbauer, *History of Induction Heating and Melting*. Essen: Vulkan-Verlag GmbH, 2008.
- [17] V. Esteve, et al., "Improving the efficiency of IGBT series-resonant inverters using pulse density modulation," *IEEE Transactions on Industrial Electronics*, vol. 58, no. 3, pp. 979-987, March 2011.
- [18] Sondheimer, E. Hi. "The mean free path of electrons in metals." *Advances in physics* 1.1 (1952): 1-42.
- [19] Sondheimer, E. H. "The mean free path of electrons in metals." *Advances in Physics* 50.6 (2001): 499-537.
- [20] Gutfleisch, Oliver, et al. "Magnetic materials and devices for the 21st century: stronger, lighter, and more energy efficient." *Advanced materials* 23.7 (2011): 821-842.
- [21] Persson, M., et al. "Soft magnetic composite materials-use for electrical machines." *Electrical Machines and Drives*, 1995. Seventh International Conference on. IET, 1995.
- [22] McLyman, Colonel William T. *Transformer and inductor design handbook*. Vol. 121. New York, NY, USA:: Marcel Dekker, 2004.
- [23] Hua, Guichao, et al. "Novel zero-voltage-transition PWM converters." *IEEE transactions on Power Electronics* 9.2 (1994): 213-219.
- [24] Stewart Xu Cheng and James S. Wallace, *Transient Behaviour of Glow Plugs in Direct Injection Natural Gas Engines*, 2012.
- [25] John M. Bailey, Carey A. Towe, Scott F. Shafer, Michael M. Blanco, *Encapsulated Heating Filament for Glow Plug*, 1992.
- [26] Akdemir B., Reisoğlu B. V., "Isıstma Bujilerinde İndüksiyon Isıtmanın Uygulanabilirliği", Selçuk Uni. Master Degree Thesis, 2017.
- [27] Akdemir B., Reisoğlu B. V., "Induction Heating Application for Glow Plugs to Obtain Flexible Heating Capability", (ICERA), Istanbul (Turkey) May 17-18, 2017, pp:227-233, <https://doi.org/10.15242/DIRPUB.DIR0517051>.