



Smart Bicycle-Sharing System Design for the Historical Peninsula of Istanbul

*

Gülce Kırdar

Istanbul Technical University
ORCID:0000-0002-4700-6077

Şehnaz Cenani

Istanbul Technical University
ORCID:0000-0001-8111-586X

Gülen Çağdaş

Istanbul Technical University
ORCID:0000-0001-8853-4207

Abstract

The paper presents a smart bike sharing system proposal with intent to promote cycling for tourists as a sightseeing trip in the Historical Peninsula of Istanbul, where high population, inadequate road infrastructure and traffic congestion make the mobility difficult. Cycling offers an alternative sustainable transportation mode to overcome these mobility challenges; it presents low costs and active mobility to the individuals, and also improves the spatial experience with urban environment. The aim of the study is to promote the use of bikes for improving visitors' (tourists) perception of the urban environment by considering bicycle demand. The research concentrates on (1) how to perform more effective bike sharing system, which is able to respond to traffic condition, and (2) adjust the bike capacity according to in user demand. The smart bike sharing system, presented in this study, consists of; 1) bike route, 2) bike use mobile application and 3) bike sharing model stages. In bike-sharing modeling process, we employ agent based modeling as decision support system. In the scope of the study, the model is evaluated through a test case that is designed by randomly selected bike park spots and terminal locations. The results showed that there is an association between bicycle demand and the number and location of bicycle facilities (bike park spots and terminals). The presented bike sharing system offers a navigation map for the visitors unfamiliar with the area and a dynamic model proposal that responds flexibly to user needs. The developed dynamic bicycle system is expected to increase the user satisfaction and thus the use of bicycles by reducing the bicycle waiting time of the users.

Keywords: *Cycling, smart mobility, smart bicycle-sharing system, agent-based modeling, decision support system.*



İstanbul Tarihi Yarımada Bölgesi için Akıllı Bisiklet Paylaşım Sistemi Tasarım Önerisi

*

Gülce Kırdar

Istanbul Teknik Üniversitesi
ORCID:0000-0002-4700-6077

Şehnaz Cenani

Istanbul Teknik Üniversitesi
ORCID:0000-0001-8111-586X

Gülen Çağdaş

Istanbul Teknik Üniversitesi
ORCID:0000-0001-8853-4207

Öz

Çalışma, İstanbul'un Tarihi Yarımada Bölgesi'nde özellikle tarihi çevreye erişim zorluğu, trafik problemi ve nüfusun fazla olması ziyaretçilerin bölgeyi deneyimlemesi açısından sorun oluşturması sebebiyle, bölgede kullanıcılar için akıllı bisiklet paylaşım sistemi önermektedir. Sürdürülebilir ulaşım aracı olarak bisiklet kullanımı bölgede hareketlilik kaynaklı sorunların çözülmesini sağlayabilir. Bisiklet kullanımı kullanıcıya düşük maliyetli ve sağlıklı erişim imkanı sunarken, aynı zamanda kullanıcının kentsel mekanı diğer ulaşım araçlarına göre daha iyi algılamasını ve deneyimlemesini sağlar. Çalışmanın amacı bölgede bisikletin ulaşım aracı olarak kullanılarak ziyaretçilerin kentsel çevreyi daha iyi algılamasını sağlamak amacıyla değişken bisiklet kullanım talebini göz önüne alarak bisiklet kullanımını arttıracak yöntemler geliştirmektir. Önerilen bisiklet paylaşım sistemi; (1) trafik durumuna ve kullanıcı isteklerine uygun, kullanıcı ile etkileşimli en etkin bisiklet ulaşımının nasıl gerçekleştirileceği ve (2) kullanım durumuna göre mevcut bisiklet terminallerinde park ve bisiklet talebinin en uygun nasıl belirlenebileceği soruları üzerinden geliştirilmiştir. Akıllı bisiklet paylaşım sistemi; 1) bisiklet rotasının tanımlanması, 2) bisiklet kullanım uygulaması ve 3) bisiklet paylaşım modeli tasarımı aşamalarından oluşmaktadır. Çalışmada karar destek sistemi yöntemlerinden biri olan etmen tabanlı modelleme yöntemi kullanılarak bisiklet paylaşım modelinin süreci tanımlanır. Çalışma kapsamında, bisiklet paylaşım modeli bisiklet park ve terminal konumları raslantısal olarak seçilerek örnek çalışma ile değerlendirilir. Örnek çalışmanın sonuçları bisiklet talebinin bisiklet servislerinin (bisiklet park ve terminal noktaları) mesafeleri ve sayıları ile ilişkili olduğunu göstermektedir. Önerilen bisiklet paylaşım sistemi, bölgeyi bilmeyen kullanıcılar için yol bulucu uygulama ve değişken kullanıcı talebine uyum sağlayabilen bisiklet paylaşım modeli sunmaktadır. Geliştirilen dinamik bisiklet paylaşım sisteminin kullanıcıların bisiklet bekleme süresini azaltarak, kullanıcı memnuniyetini ve dolayısıyla bisiklet kullanımını artırması beklenmektedir.

Anahtar kelimeler: *Bisiklet kullanımı, akıllı hareketlilik, akıllı bisiklet paylaşım sistemi, etmen tabanlı modelleme, karar destek sistemleri.*

Introduction

Cycling as a sustainable transportation mode is counted among primary topics of smart cities. Cycling has been promoted due to the traffic-related issues, (such as vehicle density, parking lot problem, traffic accident, and congestion) and resulting pollution-induced factors (noise and air pollution). According to INRIX (2018) report, Istanbul is ranked second worst European city in terms of traffic congestion; 157 hours are spent in traffic per year. This fact reveals that cycling has to be encouraged as a transportation mode in Istanbul for reducing traffic congestion. However, the rate of cycling as a transportation mode in Istanbul is not sufficient (1%) in comparison to the particular European cities (Antwerp, Bremen, Nantes, Seville, Copenhagen) as displayed in Figure 1. The inadequate roads and infrastructure, drive-centric transportation system, the topography of the site, user habit and driver attitude cause the limited use of cycling.

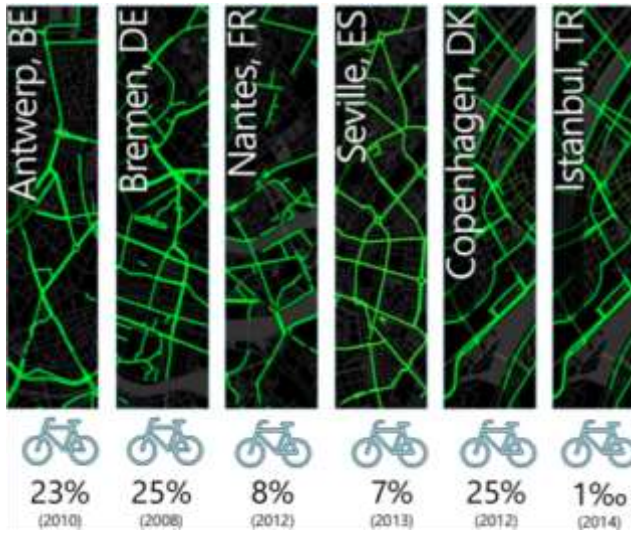

Figure 1. The rate of cycling as a transportation mode in different cities (Öztaş, 2015).

The bicycles are presented as among the most sustainable modes of urban transportation since they do not consume energy and produce emission during mobility. Promoting cycling as transportation mode provides human-centered transportation with better air quality for the city, pollution-free transportation for the environment and healthy mobility for the users at a low cost. Moreover, cycling has an impact on the spatial learning of the user. The selection of transportation modes influences the spatial

learning; pedestrians and cyclists who traveled slower than drivers perceive more details and can notice objects in greater distances in urban environment (Cenani, 2013). Accordingly, it can be stated that cycling improves the user perception and experience of urban environment. We argue that promoting cycling as a travel mode provides sustainable mobility within more interaction with urban environment (Figure 2).



Figure 2. Cycling improves user perception and experience (VisitCopenhagen, 2018). (<https://www.visitcopenhagen.com/copenhagen/sightseeing/bike-city-copenhagen>)

The benefits of cycling on user well-being and spatial learning direct researchers to develop technologies to improve bicycle facilities, infrastructure and bike use for smart and sustainable cities. Smart city can be defined as the planning and management of the city as smart systems through technology in order to improve the livability of citizens. Smart mobility, smart environment, smart economy, smart government, smart living, and smart people are the indicators of the smart city, as indicated in Figure 3a, (Cohen, 2012). Smart mobility aims to develop strategies for planning of the mobility to reduce traffic congestion and car dependence, and promote public transportation, and active mobility modes (walking and cycling) using technology. In the scope of smart mobility, the bicycle use has been supported by Information Communication Technologies (ICT) and the Internet of Things (IoT) Technology, which can be defined as intelligent transportation systems (ITS) (Behrendt, 2016). Behrendt (2016) collect smart mobility developments in the field of bike use under the concept of *smart velomobility* (Figure 3b). The developments in smart velomobility involve smart bike-sharing systems, user interactive mobile applications for cycling and bike-sharing, and connected bicycle transportation

systems. Smart velomobility technologies are associated with smart mobility concept and they target to promote cycling as an active, sustainable and connected mode of transportation using technology as a tool (Behrendt, 2016).

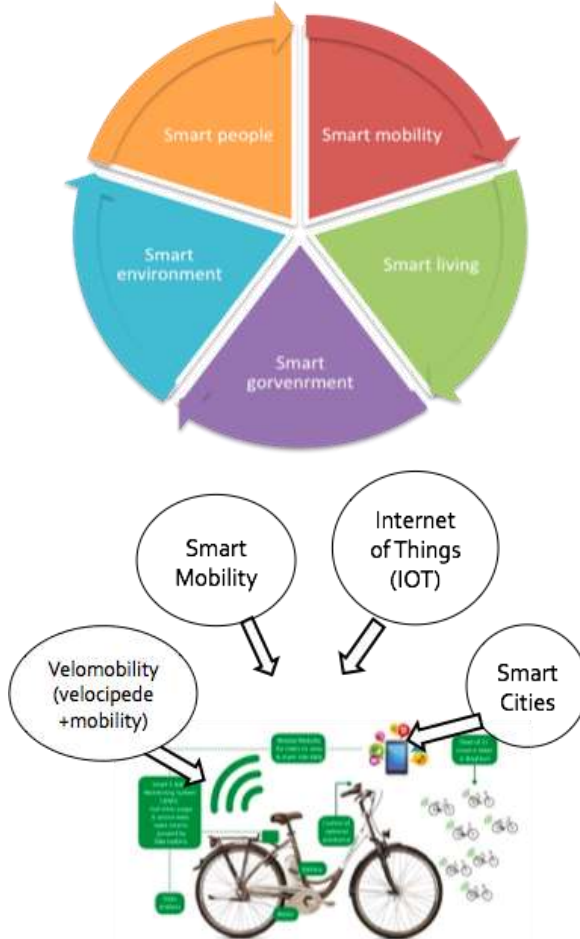

Figure 3. (a) The Smart City Wheel (Cohen, 2012) and (b) Velomobility concepts supported by technology (Behrendt, 2016).

In the context of smart velomobility technologies, bike-sharing systems have become more prevalent and ubiquitous. The public bike-sharing has started to grow since the 1960s and reached to 1175 cities in 63 different countries currently (DeMaio, 2009). Most of the European cities have developed strategies for bicycle infrastructure, and improvements for cycling facilities to make cycling attractive as a travel mode. In this scope, the trend in bike-sharing platforms has also grown in many European cities.

Some of the bike-sharing platforms are Villo! (2006) in Brussel, CityBike (2015) in Vienna, and BiciMad (2014) in Madrid (DeMaio, 2009).

In Istanbul, there have been attempts to promote cycling in recent years; however, the developments in cycling facilities and infrastructure are limited and need to be improved. As a promising development, Superpool (2017) mapped the potential bike paths in Istanbul, considering the topography of the area (max 15% incline), within the roads and highways, as displayed in Figure 4. This map can be used as a template for expanding bicycle paths. Moreover, BAKSI (Smart Bicycle Systems) has developed a bike-sharing system named as ISBIKE. ISBIKE is in use in Kadıköy-Kartal bicycle route for Asian Side, and Bakırköy-Zeytinburnu, Florya-Yeşilköy and Kuruçeşme-Sarıyer Bosphorus bicycle route in European Side of Istanbul since 2018 (BAKSI, 2018).



Figure 4. Bicycle map of Istanbul designed by Superpool Architecture (2017). (Reference: <https://www.superpool.org/index.php/research/istanbul-bike-map>)

The study focuses on promoting bicycle use as travel mode improving bike-sharing system (bicycle-sharing system). The study is conducted in the Historical Peninsula area of Istanbul. The Historical Peninsula is an attractive touristic destination, but it suffers from the negative impacts of motorized vehicles on tourist mobility. In the Historical Peninsula, the sightseeing buses for tourists lead to traffic congestion and parking problem within the increased pedestrian density (Figure 5). In 2010, a pedestrianization process has been conducted and particular streets are pedestrianized to decrease the car dependency and improve walkability in urban area (Gehl and EMBARQ, 2011). However, the vehicle dependent mobility in the area with sightseeing buses or individual cars degrades the

pedestrianization process; on the other hand, visitors would prefer to travel longer distance than walking to experience historical environment. Promoting cycling can be a solution for the mobility of the visitors. Cycling as a travel mode offers more travel distance in shorter time comparing walking, while it prevents the motorized vehicle-related issues. The study argues that improving cycling facilities in the Historical Peninsula can also support the pedestrianization process. According to the data of the survey study within the scope of the Istanbul Historical Peninsula Pedestrianization Project prepared by EMBARQ in 2014; bicycle use rate of participants is currently 1%; however, this rate may increase to 20% in the case of planning efficient infrastructure for bicycle (EMBARQ, 2014). As the survey reveals, the individuals would prefer cycling as a transportation mode, if the efficient bicycle lanes and bicycle-sharing platforms were provided. It can be stated that there is a growing demand in cycling as transport mode. The motivation of this research study is the limited bike use and demand for cycling in the area. In this study, we aim to explore alternative ways to improve bike sharing systems and encourage cycling as a mobility mode in the Historical Peninsula.



Figure 5. The pedestrian density and parking cars due to the trip buses.

The paper presents a smart bicycle sharing system proposal in the Historical Peninsula in order to promote cycling for tourists as a sightseeing trip mode. The study aims to offer a more effective bike sharing system, which is able to adapt to traffic condition and adjust the bike capacity according to user demand. We assume that this study can minimize the bike waiting time, improve user satisfaction and ultimately promote to cycling through the adaptability to alterations in traffic condition and user demand. The smart bike sharing system, presented in this study, consists of; bike route, mobile application and bike sharing model stages.

The rest of the paper is structured as follows. First, the approaches in bike-sharing systems modeling are elaborated. Second, the methodology of the bike sharing system is explained, and the system components are described. Third, the model is evaluated through a test case, and findings from the test case are indicated. Finally, the results and further developments are discussed in conclusion section.

Approaches to the Bike-Sharing System Modeling

The bicycle sharing systems have developed with the support of technologies. The bike sharing systems operate on the basic principle: individuals rent a bicycle from the bicycle terminal without owning a bicycle and use bicycles until the destination point and drops the bicycle. As the bike-sharing system is integrated with technology, the process gets more complex. Bike sharing modeling is employed to provide efficient bike-sharing process. Migley (2011) classify the bicycle sharing systems into 4 generations according to their features: First and the second generation of bicycle sharing systems provided bicycles which could be picked and returned in any location. Third generation systems employed technology including electronic locking docks, smart cards, mobile applications, built-in GPS devices in the bicycles and support with mobile applications. The fourth generation includes computation for real-data management within mobile applications, besides technological solutions such as movable docking stations, solar-powered docking stations, electric bicycles (Migley, 2011). For instance, BiciMad (2014) in Madrid, and Donkey Republic in Copenhagen, set precedent for third generation bike-sharing systems via integrated platform into public transportation, and GPS bike tracking technologies, respectively (DeMaio, 2009). CityBike (2015) in Wien sets a precedent for fourth-generation bike-sharing systems. Smart bicycle terminal points are connected with bicycles via Internet of Things (IoT) Technologies; the bicycle availability in the terminals is presented via mobile application (CityBike Wien, 2018).

Bike sharing modeling studies are developed to solve network design, management and operation issues that are encountered in the last generation bicycle sharing systems (Vogel et al., 2011). Network design and redesign issues are related to the topography, traffic and distribution of stations within the number of bicycles (Vogel et al., 2011). System-user balance management issues relate to user demand and satisfaction, while operational issues concentrate on the bicycle usage pattern (Lozano et al., 2018).

Yang and colleagues (2016) has study on promoting user satisfaction by analyzing using pattern and parking condition with existing bike-sharing data. Lozano et al. (2018) employs agent based modeling for predicting bicycle demand and Bortner et al. (2015) utilize for predicting bicycle waiting duration with intend to dimensipn the optimum bicycle number in bicycle parks. Saltzman and Bradford (2016) implement agent-based modeling to determine cycling duration by evaluating the tendency of the user to walk after leaving the bicycle. The agent-based modeling approach has been employed mainly to evaluate the bicycle demand and prediction of bike use in reference studies. In agent-based modelling, each agent represents an actor, and the interaction between each actor and environment is defined. (Sopher, Shauman, Kalay, 2016). As Sopher and colleagues (2016) state the agent-based modeling (ABM) describes how the agents behave as a result of the interaction. Understanding the interaction between agents and environment provides ABM to be used in desicision making process as decision support system. Arentze and Achten (2007) define decision support system as “interactive computer-based systems that helps people (decision makers) to improve decision making capacities in uncertain problems”. The process of decision support system consists of problem analysis, generation of alternative solutions and selection of optimum solution.

Based on the literature research, the study can be attributed as fourth generation of bicycle-sharing system. The study offers a solution to the network design issue through bicycle route map development, and to the management and operational issues through bicycle-sharing system modeling within user interactive mobile application. The focus of the study is to develop a smart bicycle sharing system that meets user demand and improves user satisfaction to promote cycling. Meeting the bicycle demand in the daily process is a determinant factor for the performance of the bicycle sharing system since it improves user satisfaction (Bortner et al., 2015). Bicycle demand is two-fold; each station should have a sufficient number of bicycles and parking for cyclists (Bortner et al., 2015). This study utilizes agent-based modeling as a method to take decisions about dimensioning bicycle capacity according to user demand. Next section points out the methodology of the smart bike sharing system and elaborates the bike-sharing model design process.

The Methodology of Smart Bicycle-Sharing System

The smart bicycle sharing system, presented in this study, includes the stages of; bicycle route, mobile application and bicycle sharing model design. The bicycle route is defined according to touristic destinations and the slope of the roads; while bicycle park and terminal points are determined according to existing tram stations, interchange points, green areas, touristic spots and cultural landmarks. The mobile bicycle use application presents the user an interactive interface; the user decides the destination and selects the spots, the mobile application displays the shortest route passing through the selected spots considering traffic condition. In the further stages, user data, taken from the application, can be used to decide the bicycle parking capacity in bicycle park and terminal points. The bicycle sharing model is developed to model the interaction between bicycle, bicycle park and terminal, bicycle sharing process, and to adapt the alteration in user demand. In this study, the relation between changing bicycle usage demand and parking capacity is associated with a product-service system which is commonly used for efficient logistic transportation; therefore, the study exploits the product-service system for the development of bicycle sharing model.

Bicycle Route Map

Landmarks become a reference point for tourists while navigating since the target group of the study is the tourist traveler who is unfamiliar to urban environment. Landmark is defined as "an object or feature of the city that is easily recognized from a distance and help individuals to be certain of their locations." (Cenani, 2013). Landmarks are important for spatial learning and the development of cognitive maps (Cenani, 2013). In general, there are two types of landmarks; global and local. Eiffel Tower and Statue of Liberty can be given as examples of global landmarks, whereas local landmarks are reference points for a specific city, neighborhood or individual (Cenani, 2013). The bicycle route is created by considering these parameters:

- cultural (global) and local landmarks, tourist destinations,
- existing tram/bus stations, interchange points
- green areas, open recreation areas
- and the incline of the roads

The slope of the roads is identified by using Bike Roll (Bikeroll, 2018), as exhibited in Figure 6. The slope of the selected roads is approximately 6% and the maximum slope of the selected roads does not exceed 12 %, therefore the route matches the criteria of being bicycle path. On the route, the bicycle terminals and bicycle parks are marked with numbers. Bicycle parks are determined according to existing tram/bus stations, green areas and local landmarks. Bicycle terminals are located considering the location of cultural (global) landmarks on touristic destination and interchange points (such as Beyazıt Square) since the bicycle demand would be more in that places, while bicycle parks are located close to the existing tram stations.

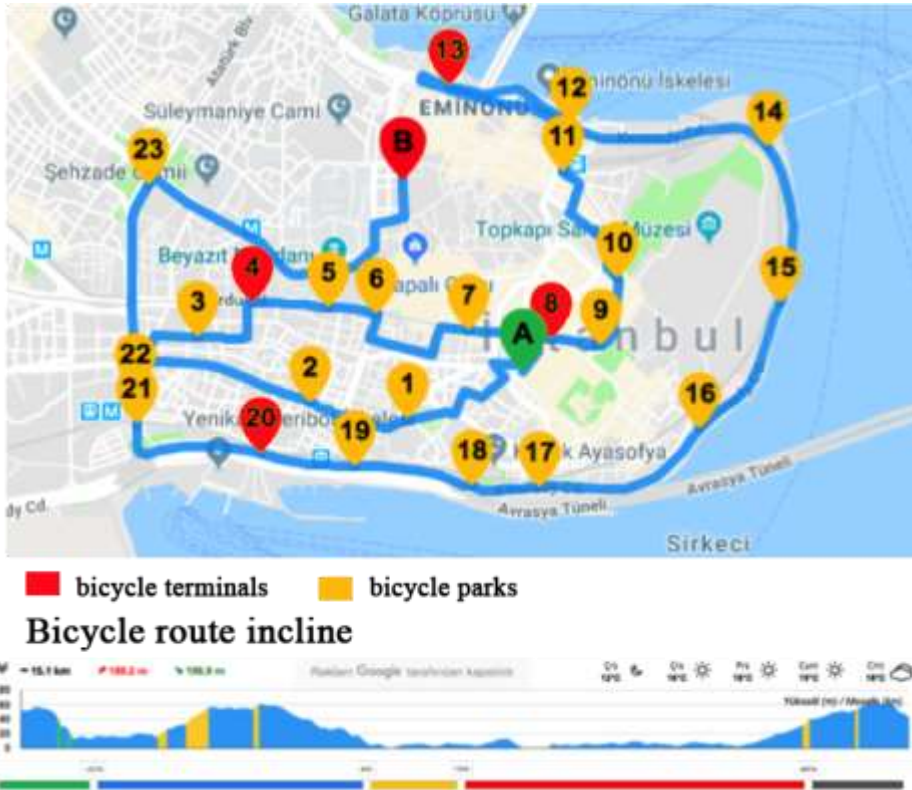

Figure 6. Bicycle route map prepared in BikeRoll application (Bike Roll, 2018). (Reference:<https://bikeroll.net/tr>)

Mobile Application

The mobile application presents an interactive interface to the user. In the application, the user decides the destination and selects the spots, the mobile application displays the shortest route passing through the selected

spots considering traffic condition. In the further stages, the study assumes that users are able to select the location of bicycle park and terminal points and define their destination routes. The user data, taken from the application, will be used to decide the bicycle parking capacity in bicycle park and terminal points. In addition, the mobile application allows the user to select the time zone; application will display different route considering traffic condition in the furtherance of the study. The user will interact with the bike sharing model via a mobile application. In the scope of the study, the conceptual framework of application interface is established, as displayed in Figure 7.

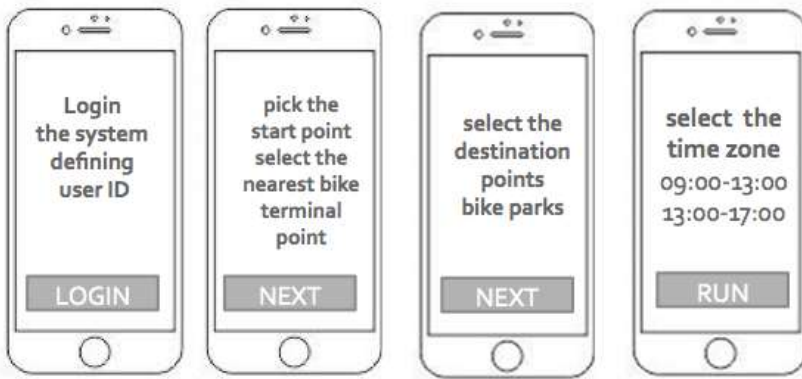

Figure 7. The interface of the mobile application.

Bicycle-Sharing Modeling

The bicycle sharing process is modeled within the interaction between bicycle, bicycle park and terminal spots, and user demand. In the literature, the relation between changing bicycle usage demand and parking capacity is associated with a product-service system which is commonly used for efficient logistic transportation (D'Albert et al.,2015). Based on the reference, our study exploits the logic of product-service system for the development of the bicycle-sharing model. In this context, bicycle terminals are associated with manufacturing center, bicycle parks are with distributors and bicycle agents are with products.

The methodology of the smart bicycle-sharing modeling depends on Decision Support System (DSS) since the problem of the balance between demand and bicycle capacity is defined as a semi-structured problem. The semi-structured problem means that the problem involves many variables

and parameters and has complex characteristics to solve with a definite algorithm. In this study, the proposed decision support system method utilizes agent-based system modeling integrated with dynamic system modeling; therefore it employs Anylogic software as a tool. The program was developed by AnyLogic Company in 2000 as multimethod modeling and simulation for modeling complex systems in different disciplines (Anylogic, 2018). This program presents advanced object library within CAD, GIS and Google maps integration (Anylogic, 2018). In this study, bicycles, bicycle parks, and terminals are defined as agents, the behavior and relations of the agents are abstracted and bicycle sharing system is modeled through agent-based modeling method in Anylogic software. Dynamic system modeling is utilized to describe the dynamic relation between bicycle usage demand and parking capacity in the bicycle sharing process. The behavior of each agent is modeled and the modeling process is demonstrated below in detail;

- A GIS (Geographic Information System) based map is located in the interface and bicycle park and terminal points are indicated. The location data of bicycle parks and terminals are introduced as input from the database (excel format) (Figure 9).
- The main agents' components are introduced to the model: Bicycle terminals, bicycle parks, bicycle (vehicle) and order (demand) agent.
- **Bicycle terminal agents** are the starting\ ending point of the trip, where the bicycles are stored and rented, they are associated with production (manufacturing) center in the product delivery system. **Bicycle park agents** are the parking spots and the transition points, they are associated with distributors in product delivery system. With **Order (demand) agent** user demands a bicycle, this triggers the system.
- In the **bicycle park agent**, bicycle demand event is generated. With the event, component demand is repeated in the specified time interval (50-100 min).
- In the **bicycle terminal agent**, the renting process is modeled with process modeling method, which depends on the total bicycle number and bicycle capacity parameters (waitForBicycles_takeVehicle_useVehicle_releaseVehicle) (Figure 8a).
- The value of used bicycle number change is defined according to renting rate bicycle number in the terminal by employing the system dynamic method for numerical abstraction. The total (net) number of the bicycle is introduced as input for deciding to wait or

- start the process through conditional operation (if the net bicycle number is smaller than required bicycle number in terminals return and wait; else start the renting process).
- In the **bicycle agent**, The action of cycling is abstracted with the statechart modeling method. The actions are represented with transitions and conditions are represented with states. An order message has been sent to start the renting process; bicycle moves from the bicycle terminal to the nearest bicycle parks; then in leaving process bicycle moves from the bicycle park to the nearest bicycle terminal. The location of the bicycle terminal and bicycle parks are taken as input from the database (Figure 8b).
 - In the **order agent**, the order is created considering the number of bicycle parks and waiting time.
 - As the output of the simulation, the number of bicycles, the bicycle parking capacity and waiting time data in bicycle terminals are represented as graphics.
 - The visual data obtained from the graphics can be used to take the decision about determining the parking bicycle capacity.

However, the Personal Learning Edition of Anylogic program has several model size limitations. For example, the program allows to create a limited number of agent types (maximum 10 agent) within agent populations (35 agents). Additionally, the evaluation use limits the integration of the program with other applications.

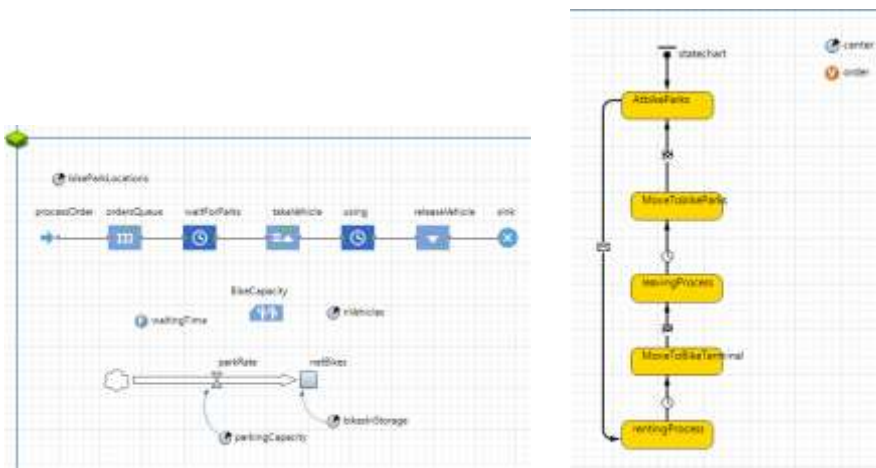

Figure 8. (a) Modeling of bicycle terminal agent's behavior using process modeling within system dynamic and (b) bicycle agent's action using statechart modeling method.

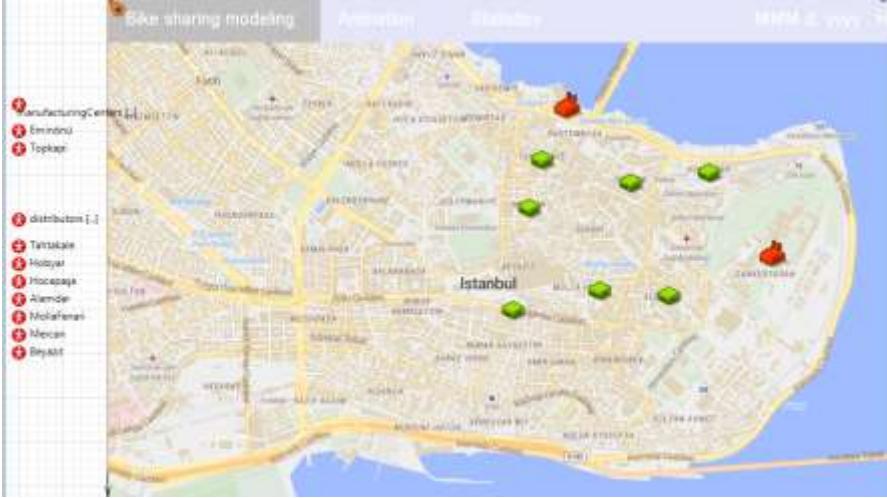

Figure 9. The interface of the program that simulates the location and action of the agent on the GIS-based map.

The presented model takes into consideration traffic condition. The artificial (synthetic) data is generated using Yandex Traffic (2018) traffic density map (Figure 10) to simulate the common daily traffic pattern of Historical Peninsula. The traffic time zone is selected manually from the options, which are regulated considering the common traffic pattern of the area (9:00-13:00/ 13:00-17:00). The main operating time of the bicycle-sharing system is decided from 9:00 to 17:00 based on (1) the visiting time of touristic spots, (2) timetable of public transportation (Mobiect, 2018), that allows bicycles in the vehicle, (3) pedestrianized time zone of Historical Peninsula. The time zone between 9:00-13:00 is decided as off-peak hours and the time zone between 13:00-17:00 is decided as peak hours. The study assumes that the mobile application will link the model with the traffic condition in further stages. Accordingly, the bicycle agent follows the vehicle or pedestrian road. If there is traffic, the bicycleTraffic agent follows pedestrian route; else bicycleNoTraffic agent follows vehicle route. There is less traffic density between 9:00-13:00, so the bicycle agent shares the road with motorized vehicles; while there is increased traffic density between 13:00-17:00, so the bicycle agent follows the pedestrian route on the GIS-based map via Route Provider variable.

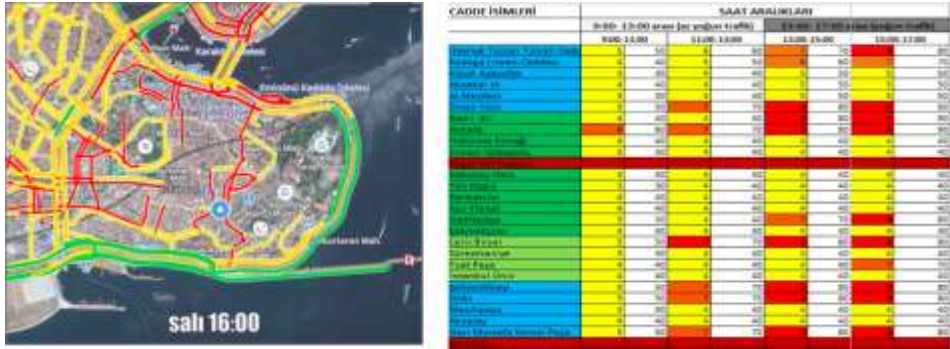

Figure 10. Traffic density map of the Historical Peninsula and the artificial traffic data obtained from Yandex.Traffic (2018). (Reference: <https://yandex.com.tr/harita/11508/istanbul>).

In the further stages of the study, we assume that the mobile application will become interacted with bicycle sharing model through user participation. Users will be able to define the location of the agents in the model via the mobile application; the user will define start and end points for bicycle terminal location and intermediate points for bicycle parking spots. The points will be taken as input from the application and the agents are located to these defined points in GIS-based map. The connection of mobile application with the system might be improved through the selection of time zone in the further stages. User will select a traffic time zone from the options, which are regulated considering the common traffic pattern of the area. The flowchart of the bicycle sharing system is illustrated in Figure 11, within the interactions between mobile application and model.

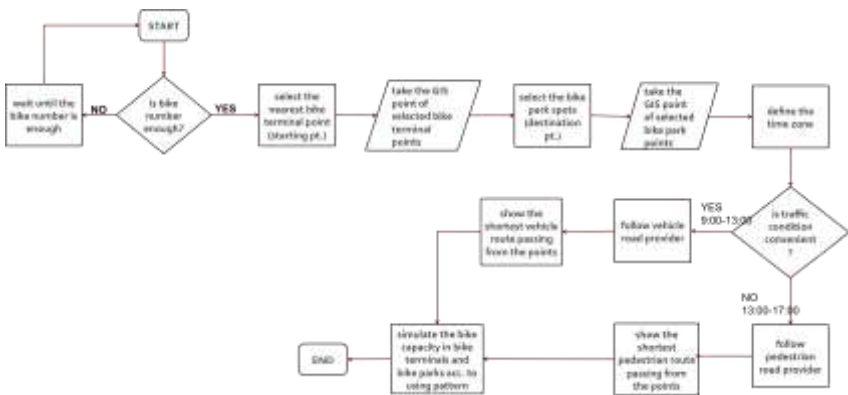

Figure 11. The flowchart diagram of the agent-based modeling.

Findings From The Case Study

A test case is designed in the selected area in the Historical Peninsula in order to evaluate the proposed bicycle-sharing model (Figure 12a). The GIS-based locations of bicycle park and terminal spots are introduced as input to the system from the database as shown in Figure 12b. As the output of the simulation, the number of bicycles, the bicycle parking capacity and waiting time data in bicycle terminals are represented as graphics through Anylogic program, as displayed in Figure 13. The bicycle parking capacity at each terminal can be determined through the evaluation of the graphics. The results of case study reveals that bicycle utilization is more in Eminönü terminal than Beyazıt and the available bicycle number is higher in Beyazıt terminal. Therefore, the bicycle demand is more in Eminönü than Beyazıt and the number of bicycles in Eminönü bicycle terminal should be higher to meet the demand. The reason can be the distance of the bicycle park points to bicycle terminal; they are clustered closer to Eminönü. They are selected randomly to evaluate the model. This reveals that the distance between the bicycle park points and bicycle terminals are important to determine bicycle demand. The location of bicycle park points can be changed to distribute the density of bicycle demand. Moreover, this test is conducted in off-peak traffic time zones; therefore, bicycles follow the pedestrian path. In the case of changing the time zone, the bicycles follow vehicle road, and this influences the bicycle number in each bicycle parking points.

In the presented study, the model is tested with only one scenario. In this study, it is possible to make conclusions for different situations by comparing the findings obtained from different parameters (such as different bicycle terminals and parking points or time zones). Different scenarios can be composed of different parameters to create alternatives. These alternative scenarios support decision-making process, and the evaluation of the alternatives can provide to take more quality decisions to dimension the capacity of bicycle terminal points.

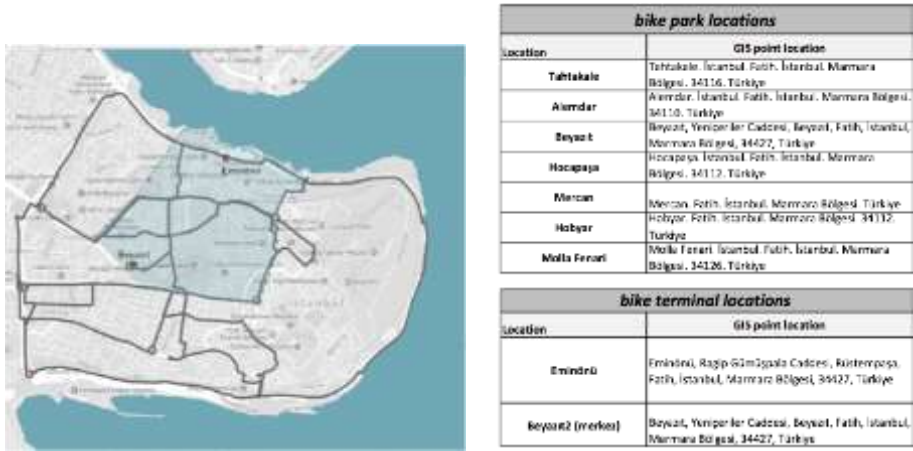

Figure 12. (a) The selected area for the case study and (b) the database of GIS locations of bicycle park and terminal spots.



Figure 13. The simulation output of the case study.

Conclusion

The aim of this study is to develop a smart bike sharing system proposal that meets user demand, and consequently improves user satisfaction, while adapts to traffic condition by changing its route. We assume that the flexibility in response to traffic conditions and adaptability to user demand might provide to minimize the bike waiting time, improve user satisfaction and consequently, to promote cycling as travel mode. The smart bike sharing system, presented in this study, consists of; bike route, mobile application and bike sharing model stages. The bicycle route is defined according to touristic spots, destinations and the slope of the

roads; while bicycle park and terminal points are determined according to existing tram stations, interchange points, green areas within touristic spots. The mobile application presents user an interactive interface; the user decides the destination and selects the spots, the mobile application displays the shortest route passing through the selected spots considering traffic condition. The bicycle sharing model is developed to model the interaction between the agents, which are a bicycle, bicycle park, and terminal points, and bicycle sharing process considering user demand by adopting agent-based modeling approach. The bicycle sharing model is evaluated through a test case that is conducted between Eminönü and Beyazıt districts, with randomly selected bike park spots.

Based on the results, it can be stated that the adaptability to alterations in user demand is achieved through agent-based modeling; however, the adaptability to traffic conditions is achieved partially. This feature can be improved in the future. This can be achieved by changing the followed path according to the time zone; however, this operation complicates the bike-sharing process since it increases the number of agents (bicycleTraffic and bicycleNoTraffic agents). The study concentrates on the bike-sharing modeling and offers design proposals for mobile application. While the study offers a holistic perspective to bike sharing systems, the scope of the paper is limited with the implementation of the model and design guidelines for mobile application. The interoperability of the mobile application and bike-sharing model will be handled in the further stages of the study. It is expected that the interaction between mobile application and bike-sharing model might change the bike-sharing process. Moreover, the bike-sharing system modeling is performed using Anylogic software. The software has several limitations in Personal Learnig Edition; the model is limited to 10 agent types, 35 agent populations (Anylogic, 2018). This means that the number of bike park spots and terminal points are 10, and bike agents are 35 at maximum. Due to this limitation, the case study is conducted with a limited number of agents. Therefore, the association between each bike parking spots and bike terminal points could not be modeled and the general bike-demand pattern could not be obtained due to this limitation in the scope of the study.

It can be concluded that developing a holistic bicycle sharing system, integrating simulation modeling and mobile application, has potential to improve user satisfaction. It provides more user-centric solutions in the bike-sharing system by considering user interaction and demand. The results of the study are twofold; it presents a navigation map proposal for

the visitors unfamiliar with the area, and a model proposal that can predict the bicycle parking capacity according to user demand. In bicycle sharing system, there is a need for a smart and dynamic bicycle sharing system that responds flexibly to user needs since the required number of bicycles changes in time, depending on the number of user and traffic condition. As a solution, the study offers a smart and dynamic bicycle sharing system with intent to improve cycling as a sustainable transportation medium. The bicycle waiting time is minimized, user satisfaction is improved and ultimately, cycling is promoted via the developed bicycle sharing model. It is expected that the study contributes to promoting cycling in the Historical Peninsula by improving user satisfaction. Moreover, bike-sharing modeling can support the decision process in terms of the development of cycling facilities and dimensioning bicycle capacities. In this way, the user demand can be taken into consideration in the planning stage of the facilities. Within the efficient cycling tracks and infrastructure, the proposed bicycle sharing system has the potential to support cycling as a sustainable transportation mode. In further stages, the aim of the study is to combine the bike-sharing modeling with a mobile application to make the system smarter and interactive. The study also seeks to implement the bicycle-sharing system in different locations of Istanbul where is appropriate for cycling in further stages.

References

- Anylogic. (n.d.). Retrieved October 2, 2018, from <https://www.anylogic.com/>
- Arentze, H. and Achten, H. (2007). *Design and decision support systems in architecture and planning*. Unpublished manuscript, Eindhoven.
- Baksi Akıllı Bisiklet Kiralama Sistemleri [BAKSI]. (2018). Retrieved October 2, 2018, from <https://www.isbike.istanbul/>
- Behrendt, F. (2016). Why cycling matters for smart cities, Internet of bicycles for intelligent transport. *Journal of Transport Geography*, 56, 157-164.
- BikeRoll. (2018). BikeRoll. Retrieved October 5, 2018, from <https://bikeroll.net/tr>
- Bortner, C. W., Gürkan, C. and Kell, B. (2015). *Ant colony optimization applied to the bike sharing problem*. Retrieved October 2, 2018, from https://www.math.cmu.edu/CNA/summer_institute/2015/projects/ACOBSP.pdf
- Cenani, S. (2013). Modeling cognitive learning of urban networks in daily activity-travel behavior. Issue 186, Bouwstenen Series. Eindhoven: Technische Universiteit Eindhoven. DOI: 10.6100/IR759267.
- CityBike. (2018). CityBike Wien. Retrieved October 2, 2018, from <https://www.citybikewien.at/en/>

- Cohen, B. (2012). *What exactly is a smart city?*. Retrieved October 2, 2018, from <http://www.fastcoexist.com/1680538/what-exactly-is-a-smart-city>
- D' Albert H., Venkataraman S. and Omer, M. (2015). Application of System Dynamics for Modeling Product-Service Systems. In *Proceedings of ICETA Conference*. Taipei: Taiwan.
- DeMaio, P. (2009). Bike-sharing: History, Impacts, Models of Provision, and Future. *Journal of Public Transportation* 12 (4), 41-56.
- EMBARQ Türkiye. (2014). *İstanbul Tarihi Yarımada yayalaştırma projesi mevcut durum değerlendirilmesi*. Retrieved May 2, 2018, from www.embarqturkiye.org
- Gehl Architects and EMBARQ. (2011). Istanbul public space public life. Retrieved October 11, 2018, from https://issuu.com/gehlarchitects/docs/issuu_998_istanbul_public_spaces-pu/48
- INRIX. (2018). *Global traffic scorecard*. Retrieved October 11, 2018, from <http://inrix.com/scorecard-city/?city=Istanbul&index=2>
- Istanbul ranked 15th most congested city in the world. (2017). *Hurriyet Daily News*. Retrieved October 5, 2018, from <http://www.hurriyetdailynews.com/istanbul-ranked-15th-most-congested-city-in-world--110036>
- Lozano, A., De Paz, J., Gonzalez, G., V., Iglesia, D. and Bajo, J. (2018). Multi-Agent System for Demand Prediction and Trip Visualization in Bike Sharing Systems. *Journal of Applied Sciences*. Retrieved from: www.mdpi.com/journal/applsci Retrieved on 12 October 2018.
- Mátrai, T. and Tóth, J. (2016). Comparative assessment of public bike sharing systems. *Transportation Research Procedia*, 14, 2344-2351. DOI: 10.1016/j.trpro.2016.05.261
- Midgley, P. (2011). Bike-sharing schemes: Enhancing sustainable mobility in urban areas. *Commission on Sustainable Development* 19, Background Paper 8, 1-24.
- Mobiett. (2018). Mobiett. [Mobile application software]. Retrieved October 5, 2018, from <https://www.iett.istanbul/tr/main/pages/mobiett/775>
- Öztaş, Ç. (2015). *Transport policies in Istanbul. Presentation at sciencespo*. Retrieved October 10, 2018, from <http://wrisehirler.org/medya/transport-policies-istanbul-l-%C3%A7i-%C4%9Fdem-%C3%A7-%C3%B6rek-%C3%B6zta%C5%9F-l-sciencepo>
- Pucher, J. and Buehler, R. (2017). Cycling towards a more sustainable transport future. *Transportation Reviews*, 37 (6), 689-694, DOI: 10.1080/01441647.2017.1340234
- Saltzman, R. and Bradford, R. (2016). Simulating a mode Efficient Bike System. *Journal of Supply Chain and Operations Management*, 14(2), 36-47.
- Sopher, H., Shauman, D. and Kalay, Y. (2016). Simulating Human Behavior in (un)Built Environments: Using an Actor Profiling Method. *International Journal of Computer, Electrical, Automation and Information Engineering*, 10(12), 2030-2040. Retrieved from scholar.waset.org/1999.4/10006638
- Superpool (2017). *Istanbul bike map*. Retrieved October 5, 2018, from <https://www.superpool.org/index.php/research/istanbul-bike-map>
- VisitCopenhagen. (2019). *Bike city Copenhagen*. Retrieved October 5, 2018, from <https://www.visitcopenhagen.com/copenhagen/sightseeing/bike-city-copenhagen>
- Vogel, P., Greiser, T. and Mattfeld, D.C. (2011). Understanding bike-sharing systems using Data Mining: Exploring activity patterns. *Procedia Social Behavioral Scienc-*

es, 20, 514–523.

- Yandex. (2018). Yandex Harita. Retrieved October 12, 2018, from <https://yandex.com.tr/harita/11508/istanbul>
- Yang, Z., Shu, Y., Cheng, P., Chen, J. and Moscibroda, T. (2016). Mobility modeling and prediction in bike-sharing systems. in proceedings of *mobile systems, Applications, and Services* (MobiSys'16), Singapore.

Gulce Kirdar studied Architecture at Bahcesehir University (BAU). She received her MSc degree from Architectural Design Computing Graduate Program at ITU, and recently has studied PhD in the same program since 2017. She studied as Research Assistant in Architecture Department in Altınbaş University, between 2015-2018. Her research interest involve material computation and smart cities in the context of computational urban analysis.

Gülce Kırđar, Bahçeşehir Üniversitesi Mimarlık bölümünden mezun olmuştur. Yüksek Lisans derecesini İstanbul Teknik Üniversitesi Mimari Tasarımda Bilişim alanından almıştır. 2015-2018 yılları arasında Altınbaş Üniversitesi Mimarlık Bölümü'nde Araştırma Görevlisi olarak çalışmıştır. Doktora çalışmalarını aynı bölümde 2017 yılından itibaren sürdürmektedir. Malzemenin hesaplanabilirliği ve akıllı şehir kapsamında hesaplanabilir kentsel analiz yöntemleri başlıca araştırma alanlarını oluşturmaktadır.

Dr. Sehnaz Cenani studied Architecture at Istanbul Technical University (ITU), Turkey. She received her MSc degree from Architectural Design Computing Graduate Program at ITU, and received her PhD degree at Eindhoven University of Technology (TU/e), the Netherlands. Her research interests lie in the area of decision support systems, ranging from theory to design to implementation. Her research interests include smart cities, smart mobility, computational design in architecture and shape computation. She is also interested in cognitive processes involved in individuals' daily activity-travel behaviour and development of spatial cognition.

Dr. Şehnaz Cenani, İstanbul Teknik Üniversitesi (İTÜ) Mimarlık bölümünden mezun olmuştur. Mimari Tasarımda Bilişim alanında Yüksek Lisans derecesini İTÜ'den almıştır. Doktora çalışmasını ise Hollanda'da Eindhoven Teknik Üniversitesi'nde (TU/e) yapmıştır. Mimarlıkta karar destek sistemlerinin tasarlanması ve uygulanması, akıllı şehirler, akıllı ulaşım, mimarlıkta hesaplamalı tasarım ve biçim çalışmaları başlıca araştırma alanlarını oluşturmaktadır. Ayrıca, bireylerin günlük aktivite-seyahat davranışlarının bilişsel süreçlere etkisi ve mekansal bilişin gelişimi konuları üzerinde de çalışmalarda bulunmuştur.

Gülen Çağdaş has graduated from Istanbul Technical University, Faculty of Architecture. She began as teaching assistant in 1981 at the same faculty. She took her Ph.D. degree on Architectural Design from the same university in 1986. She has become Assistant Professor in 1987, Associate Professor in 1989 and Professor in 1997. She held the Vice Dean position of Faculty of Architecture between 1997 and 2000, was the Head of

Architectural Design Chair between 2004 and 2007 and also Department Head of Architecture between 2008 and 2012. She was the Coordinator of Architectural Computing Graduate Program between 2000 and 2015 and also Department Head of Informatics at the Institute of Science, Engineering and Technology, ITU between 2006-2018. Her main research area is Architectural Design Computing (Web page: <http://akademi.itu.edu.tr/cagdas/>).

Gülen Çağdaş İstanbul Teknik Üniversitesi Mimarlık Fakültesinden mezun oldu. 1981 yılında aynı fakültede Araştırma Görevlisi kadrosuna atandı. 1986 yılında İTÜ Fen Bilimleri Enstitüsünden Bina Bilgisi alanında Doktora derecesini aldı. Mimarlık Fakültesi Mimarlık Bölümünde 1987 yılında Yardımcı Doçent, 1989 yılında Doçent ve 2007 yılında Profesör kadrolarına atandı. 1991-1994 yılları arasında Mimarlık Bölümü Başkan Yardımcılığı, 1997-2000 yılları arasında Mimarlık Fakültesi Dekan Yardımcılığı, 2004-2007 yılları arasında Bina Bilgisi Anabilim Dalı Başkanlığı ve 2008-2012 yılları arasında Mimarlık Bölüm Başkanlığı görevlerini yaptı. 2000-2015 yılları arasında İTÜ Fen Bilimleri Enstitüsü Mimari Tasarımda Bilişim Lisansüstü Programı kurucu Koordinatörlüğü ve 2006-2018 yılları arasında da aynı enstitüde Bilişim Anabilim Dalı Başkanlığı yaptı. Mimari Tasarımda Bilişim alanında araştırmaları ve yayınları bulunmaktadır. (Web page: <http://akademi.itu.edu.tr/cagdas/>).