



POLİTEKNİK DERGİSİ

*JOURNAL of POLYTECHNIC*

ISSN: 1302-0900 (PRINT), ISSN: 2147-9429 (ONLINE)

URL: <http://dergipark.org.tr/politeknik>



# Ergonomic analysis based on digital human modelling: adjustable school furniture design for secondary school students

*Dijital insan modelleme tabanlı ergonomik analiz: ortaokul öğrencileri için ayarlanabilir okul mobilyası tasarımı*

*Yazar(lar) (Author(s)): Mehmet İsmail SARI<sup>1</sup>, İsmail ŞAHİN<sup>2</sup>*

*ORCID<sup>1</sup>: 0000-0002-4920-1888*

*ORCID<sup>2</sup>: 0000-0001-8566-3433*

**Bu makaleye şu şekilde atıfta bulunabilirsiniz (To cite to this article):** Sarı M. İ., Şahin İ. “Ergonomic analysis based on digital human modelling: adjustable school furniture design for secondary school students”, *Politeknik Dergisi*, 23(4): 1097-1110, (2020).

**Erişim linki (To link to this article):** <http://dergipark.org.tr/politeknik/archive>

**DOI:** 10.2339/politeknik.607557

# Ergonomic Analysis Based on Digital Human Modelling: Adjustable School Furniture Design for Secondary School Students

## Highlights

- ❖ The school furniture, whose height and slope can be adjusted, is designed in accordance with the anthropometric features of the students.
- ❖ Ergonomic analysis was carried out with RULA - Rapid Upper Limb Analysis.
- ❖ Digital Human Modeling (DHM) was used in the analysis.
- ❖ The limbs were colored from green to red in the RULA analysis
- ❖ The furniture we designed has achieved a better RULA score than the furniture used in schools.

## Graphical Abstract

In this study, school furniture was designed and ergonomic analysis was done with DHM.



**Figure.** DHM analysis and school furniture design.

## Aim

In this study, it is aimed that the students can maintain their ideal posture while drawing in design-oriented lessons with school furniture that is suitable for the anthropometric features and whose height and slope can be adjusted.

## Design & Methodology

The student desk and the chair were designed in consideration of the anthropometric data obtained from the students. Ergonomically evaluation of the school furniture designed was carried out through RULA – Rapid Upper Limb Analysis. During the tests and the analyses, Digital Human Models (DHM) matching the anthropometric measures determined within the study were used.

## Originality

Ergonomic analysis of the designed school furniture was done using RULA and DHM.

## Findings

It was determined that the school furniture designed in a way that the slope and height could be adjusted is more suitable and ergonomic for the antropometric properties of secondary school students in the risk analysis with DHM.

## Conclusion

As a result of the analysis, it was seen that the designed furniture had a better RULA score than the known school furniture.

## Declaration of Ethical Standards

The author(s) of this article declare that the materials and methods used in this study do not require ethical committee permission and/or legal-special permission.

# Dijital İnsan Modelleme Tabanlı Ergonomik Analiz: Ortaokul Öğrencileri İçin Ayarlanabilir Okul Mobilyası Tasarımı

*Araştırma Makalesi / Research Article*

**Mehmet İsmail SARI<sup>1</sup>, İsmail ŞAHİN<sup>2\*</sup>**

<sup>1</sup>Fen Bilimleri Enstitüsü, Endüstriyel Tasarım Müh. Ana Bilim Dalı, Gazi Üniversitesi, Türkiye

<sup>2</sup>Teknoloji Fakültesi, Endüstriyel Tasarım Müh. Bölümü, Gazi Üniversitesi, Türkiye

(Geliş/Received : 20.08.2019 ; Kabul/Accepted : 30.10.2019)

## ÖZ

Öğrencilerin akademik başarılarını ve sağlıklarını etkileyen bir çok neden vardır. Bu nedenlerden biri de okul mobilyalarının ergonomik olmamasıdır. Bu çalışmada, öğrenilerin antropometrik özelliklerine uygun, yüksekliği ve eğimi ayarlanabilen okul mobilyaları ile tasarım odaklı derslerde çizim yaparken ideal duruşlarını koruyabilmeleri amaçlanmıştır. Öğrenci mobilyası öğrencilerden elde edilen antropometrik veriler doğrultusunda tasarlanmıştır. Yüksekliği ayarlanabilir oturak öğrencilerin bacak boylarına göre üç farklı yükseklikte, tasarlanan masa ise eğimli olarak kullanılabilir. Mobilyaların ergonomik analizi RULA-Üst Ekstremité Analizi ile gerçekleştirilmiştir. Analizlerde, elde edilen antropometrik verilere uygun olarak Dijital İnsan Modelleri (DHM) kullanılmıştır. Modeller yoluyla yapılan analizler sayesinde risk değerlendirmeleri yapılmıştır. RULA analizinde ergonomik konumda pozisyonlanan uzuvlar yeşilden kırmızıya doğru renklendirilmiştir. Analizler neticesinde, tasarlanan mobilyanın, bilinen okul mobilyalarına oranla daha iyi RULA skoru elde ettiği görülmüştür.

**Anahtar Kelimeler:** DHM, ergonomik analiz, antropometri, ergonomik tasarım, okul mobilyası.

## Ergonomic Analysis Based on Digital Human Modelling: Adjustable School Furniture Design for Secondary School Students

### ABSTRACT

There are many reasons that affect students' academic achievement and health. One of the reasons is that school furniture is not ergonomic. Designed in this paper are student chairs and desks, which are height adjustable and inclinable, are suitable for the anthropometric characteristics of the students and which would ensure that students maintain their ideal body postures in design oriented classes, especially while making drawings. The student desk and the chair were designed in consideration of the anthropometric data obtained from the students. The height-adjustable seat can be used at three different heights according to the leg length of the students and the designed table can be used inclined. Ergonomically evaluation of the school furniture designed was carried out through RULA – Rapid Upper Limb Analysis. During the tests and the analyses, Digital Human Models (DHM) matching the anthropometric measures determined within the study were used. Risk assessments were conducted in this study with the help of the ergonomics analyses carried out with DHMs. In the RULA analysis, the limbs positioned in the ergonomic position were colored from green to red. As a result of the analysis, it was seen that the designed furniture had a better RULA score than the known school furniture.

**Keywords:** DHM, ergonomics analysis, anthropometry, ergonomic design, school furniture.

### 1. INTRODUCTION

Nowadays, methods in which the students participate in the activities conducted as much as possible are preferred by the educationists over teaching methods, which prevent students from actively participating into the classes [1]. Curriculums are thus being re-considered in a way to ensure learning by doing and living in a simplified manner. However, re-designing the curriculum in such manner would not be adequate in terms of the efficiency of the curriculum. Apart from the re-designed curriculums, the venues in which the

teaching and learning activities are conducted should also be designed to enable performing such activities.

The scientific researches made demonstrate that the wrongdoings in physical environment affect the focus of the students into the subject as well as their behaviour and learning [2]. The school furniture that are not produced in compliance with the anthropometric measurements of the students is one of the most significant of these wrongdoings. Such school furniture may carry forward the muscle-skeleton problems of the students into the adulthood. In children in adolescence period, in which the growth, in particular, rapidly occurs, postural and orthopaedic disorders are often experienced. Therefore,

\*Sorumlu Yazar (Corresponding Author)  
e-posta : isahin@gazi.edu.tr

the physical environment and the products used (chairs, desks etc.) should be designed in accordance with their anthropometric measurements. The researches made show that only a limited number of student use school furniture that are fit for their anthropometric measures [3]. Yet, the anthropometric values differ depending on many variables such as age, region, eating and drinking habits, gender, nationality and health [4].

In applied classes in particular, where activities go beyond the writing on the desks, non-ergonomic positions emerge for the students. In consideration of this phenomena, functionality-increased designed are needed. For instance, for a student to do draft-rough copy studies in a Technology and Design class, s/he will need a desk that the tilt angle can be adjusted. The Technology and Design class aim to educate / train individuals who are literate in industrial design, architectural design and graphical design who are able to create unique products, are able present their products and have comprehensive knowledge about the design process. In this class, the students are expected to turn their studies into drawings, models or products. Therefore, the chairs and desk on which the students carry out their studies should be suitable for the anthropometries of the students as well as for making drawings, models and products.

It is seen that some of the student desks being already used in Turkey, where this study is being conducted, are the ones that were produced with the help of the data obtained through the anthropometric studies carried out in United Kingdom or in Germany or ones that were produced based on no such study at all [5]. While use of school furniture produced without taking into account the anthropometric measurements in education /training may result in muscle-skeleton disorders in students, it may decrease the performance of the students as well [6]. This is a real threat in terms of the health of students.

There are few studies made on the design of ergonomic school furniture to be used in drawing making classes especially in design-oriented classes. This grabs attention as a significant shortage. In design of ergonomic furniture, design that is suitable for the anthropometry of the humans is essential. In this study, a study was conducted for this deficiency in the literature.

As seen in literature, studies made on the ergonomically production of the school furniture are quite few in number. The studies are mainly focused on;

- Influence of the existing furniture on the performance of the students and research of the health problems that may arise on the skeleton system,
- Collection and analysis of the data required for the design of furniture that would meet the anthropometric features of the students,
- Determination of the anthropometric measurements for ergonomic school furniture in the light of these data.

The study was carried out in accordance with the process steps in Figure 1.

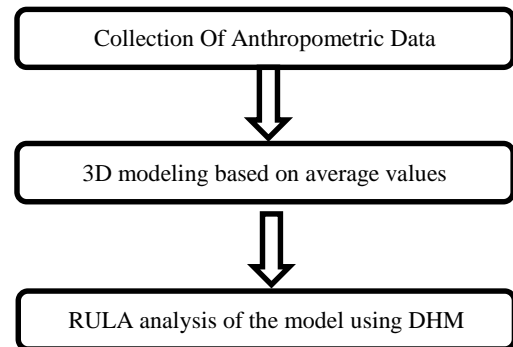

**Figure 1.** Working Steps

This paper differs from others in research of the health problems the existing furniture of the students pose on the musculoskeletal system, in collection of the anthropometric data to be used in design of ergonomic school furniture and in design of ergonomic school furniture in accordance with these data. The paper makes a contribution to the field by embracing all these three subjects in one. Another significant contribution of this paper to the literature is that a computer-assisted ergonomic analysis of the ergonomic school furniture designed is made. Another important contribution of this article in the literature is the computer-assisted ergonomic analysis of ergonomic school furniture, which was first designed within a previous study [4]. The ergonomic performance of the design has been observed by the DHM-based analysis. With the DHM based ergonomic analysis approach carried out on the furniture design makes it possible to monitor the ergonomic performance that the furniture will demonstrate at the stage of use right at the design stage. This brings innovation to the studies made in the field.

## 2. LITERATURE REVIEW

There are studies in literature made on the ergonomic furniture design. Most of these studies focus on the ergonomics of the furniture used in work stations [7, 8]. The studies, however less in number, made on the ergonomic school furniture considering the anthropometric measurements of the students however, cover the research of the existing situation and theoretical suggestions required for ergonomic design rather than a concrete furniture design. The study of Taifa and Desai is a good sample of these studies. Taifa and Desai made a research on the selection criteria and measurements required for the design of an adjustable desk and a chair for the use of their students and created an anthropometric database [9]. It does not contain a concrete design. The study of Oyewole et al., however, suggests guidelines and a methodology for the design of an ergonomics-oriented school furniture for students. Regression equations were used for the measurements of

the school furniture in the study in which the anthropometric data of twenty grade-1 students were used [10]. The study of Knight and Noyes are intended for the definition of the basic functionality of the school furniture. In the study, it was pointed out that effective school furniture would enhance the effective learning as the postures and behaviours of the students would best be monitored when they are seated apart from the minimising the distracting factors in school furniture [11]. Castelucci et al., made a comparison on three different school furniture sizes in terms of the anthropometric measurements of the students in Valparasi region of Chile for a purpose to observe a possible mismatch. On the study made in 3 different schools in 3 different economic classes, it was seen that the school furniture did not meet the anthropometric requirements [12]. In another study of the very same researchers, they discussed the criteria equation to define the mismatch between the students and the school furniture, applied these criteria on a specific sample and suggested a methodology to assess the suitability of the school furniture based on the results [13, 14]. Agha and Alnahhal, in their studies, endeavoured to estimate measurements in design of school furniture (chairs) for primary school pupils, using ANN – Artificial Neural Networks and regression analysis [15]. Castelucci et al. conducted a study to determine whether the design and/or sizes of the school furniture would affect the physical reactions and/or performances of the students. The

school furniture would minimise the musculoskeletal symptoms among the pupils [17]. In the sampling study conducted by Hoque et al. among 500 university students in four different academic levels, the relation between the body dimensions was evaluated and the coherence between the body dimensions of the students and the school furniture was assessed. Significant mismatches were identified at the end of the study and ergonomic furniture dimensions were suggested [18]. In a similar study, ergonomic suitability of the educational furniture in university conference rooms was evaluated [19]. Results of the study present basic information on the anthropometric measurements of the university students and also on the suitability of the lecture rooms. Jung made and adjustable desk and a chair using the standards suggested by ISO 5970 and instructions of Lueder [20]. The study differs from other studies in containing a concrete product design. However, in that study the products were developed considering the standards rather than an anthropometric study conducted [21].

### 3. RESEARCH METHODOLOGY

#### 3.1 Anthropometry

Anthropometry is a measuring science and application art determining the physical geometry, mass features and strength abilities of the human body. The study field dealing with the metric values measured in static postures and seating positions of the humans is called static

**Table 1.** Significant Anthropometric Measurements for Ergonomic Designs [22].

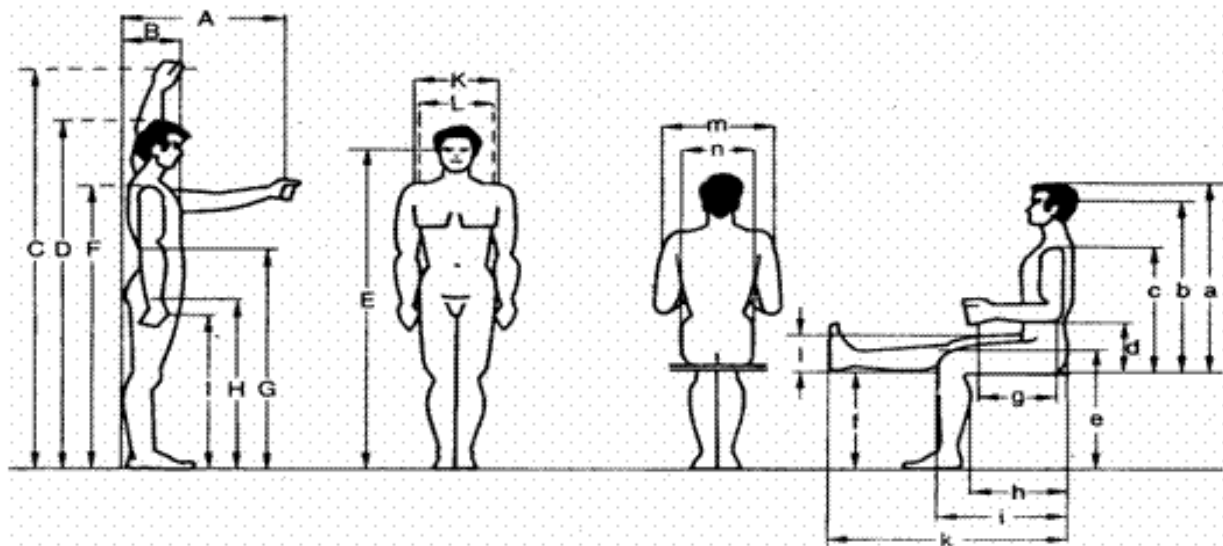

results of the study revealed that the design of the school furniture did have a positive impact on the in-school behaviour, energy consumption and attention span of the students [16]. Saarni et al. compared the impacts of the ergonomically designed school furniture (desks and chairs) on the musculoskeletal system of the students to that of the conventional furniture. The study failed to confirm the hypothesis that ergonomically designed

anthropometry and the one dealing with the arms, legs and bodies of humans during working is called dynamic anthropometry [28]. Anthropometric measurements and measurement positions are shown in Table 1

Description		Male			Female		
		Lower Limit	Average Value	Upper Limit	Lower Limit	Average Value	Upper Limit
<u>Standing</u>							
A	Frontward Stretching Distance	622	722	787	616	690	762
B	Chest Depth	233	276	318	238	285	357
C	Upward Stretching Distance with Two Arms	1910	2051	2210	1748	1870	2000
D	Height	1629	1733	1841	1510	1619	1725
E	Height of Eye	1509	1613	1721	1402	1502	1596
F	Shoulder Height	1349	1445	1542	1234	1339	1436
G	Elbow Height	1021	1096	1179	957	1030	1100
H	Perineum Height	752	816	806	-	-	-
I	Height of Hand	728	767	828	664	738	803
K	Shoulder Breadth	367	398	428	323	355	308
L	Hip Breadth	310	344	368	314	358	405
<u>Seated</u>							
a	Height of Upper Body	849	907	962	805	857	914
b	Height of Eye	739	790	844	680	735	785
c	Shoulder Height	561	610	655	538	585	631
d	Elbow Height	193	230	280	191	233	278
e	Popliteal Height	493	535	574	462	500	542
f	Height of Calf	399	442	480	351	395	434
g	Elbow–Palm(Gripping Axis) Breadth	237	362	389	292	322	364
h	Body Depth	452	500	552	426	464	532
i	Hip – Popliteal Breadth	554	599	645	530	587	631
k	Hip – Sole Breadth	964	1035	1125	955	1044	1126
l	Femoral Thickness	117	136	157	118	144	173
m	Breadth between Elbows	399	451	512	370	456	544
n	Hip Breadth	325	362	391	340	387	451

Each society has its own unique anthropometric values and knowing these anthropometric values gains favour in all kinds of studies and designs made for the target audience in the fields such as medicine, engineering, architecture and industrial design etc. [23].

Anthropometric data are used in ergonomically determining the physical dimensions of all tools, equipment, furniture and clothing. Therefore, dimensions of the tools and the equipment are made suitable for the users [24, 25]. Without knowing the anthropometric values, rational and correct design of

places cannot be made. However excellent a product is in terms of technicality, if it is not suitable for the measurements and biomechanical features of the user, it cannot be used effectively [26, 27]. Anthropometric data were collected for ergonomic design of school furniture.

As per Hertzberg who evaluated the anthropometric measurements made in 1950's, the most significant 30 measurements for ergonomic designs are height, hip breadth, upper body height from hip, hip-elbow height, height of eye from hip, hip-leg clearance, shoulder breadth, elbow height, shoulder-elbow length, elbow-

hand length, elbow-wrist length, popliteal height, hip height, depth of stomach, thickness of leg, foot length, hand length, hand breadth and palm length [28].

**3.2 RULA (Rapid Upper Limb Assessment) Analysis Method**

Continuous repetition of painful positions while working creates fatigue and may cause skeletal-muscle disorders in the long term [29]. RULA can be used to detect these disorders [30]. Ergonomic analyses of the desk and the chair designed as part of the study were carried out in RULA analysis. RULA – Rapid Upper Limb Assessment Method is a method of survey developed to be used in workplaces where occupational upper limb disorders are reported and in researches made in ergonomics. While this method assesses the muscle functions of the neck, body and upper limb postures, it also enables the rapidly evaluation of the external forces that the body encounters.

In this method, the movements, standing postures, fixed muscle moves and the physical forces the person becomes subjected to, are assigned risk evaluation scores using a series of scoring systems. The risk evaluation scores obtained enables the ergonomic analysis of the project. The scoring is between scales of “1 – Low Risk” and “7 – Highly Risky” Results being too high or too low do not implicitly guarantee a work place is dangerous or safe.

There are two main posture analysis tables in the method, being A and B. Table A lists the arm and wrist analyses

and the table B lists the analyses of neck, trunk and leg. In order to find the score of the Table A, posture angles of upper arm, lower arm and wrist need to be determined. Twists in lower arm and the wrist would affect the score. Another score is added on the score obtained from Table A depending on the muscles being static of continuously working. An additional score is finally added depending on the amount of force or load, the results of the “Arm and Wrist” are obtained to be placed in Table C.

For the score of the Table B, angles of the postures of the neck, trunk and the leg are measured. The values obtained through the scores will give the results for the Table B. Depending on whether the muscles are static or continuously working, a score is added on the values. An additional scoring is performed depending on the amount of the force and the load. Through the results obtained, the score of “Neck, Trunk and Leg” is obtained.

When Table C is considered, the results obtained from Table A are marked on the values in the first column and the results obtained through the Table B are marked on values on the upper lines. Correlation of the two results then gives out the final score of the Table C. If the result is 1 or 2, the risk evaluation is acceptable. If the result is 3 or 4, that indicates that the risk exists, it needs to be evaluated and it may need some amendments. Results being in values of 5 or 6 indicate that the situation needs to be evaluated and corrections will need to be made in the near future. A result in the value of 7 indicates that this way of working is risky (Figure 2).

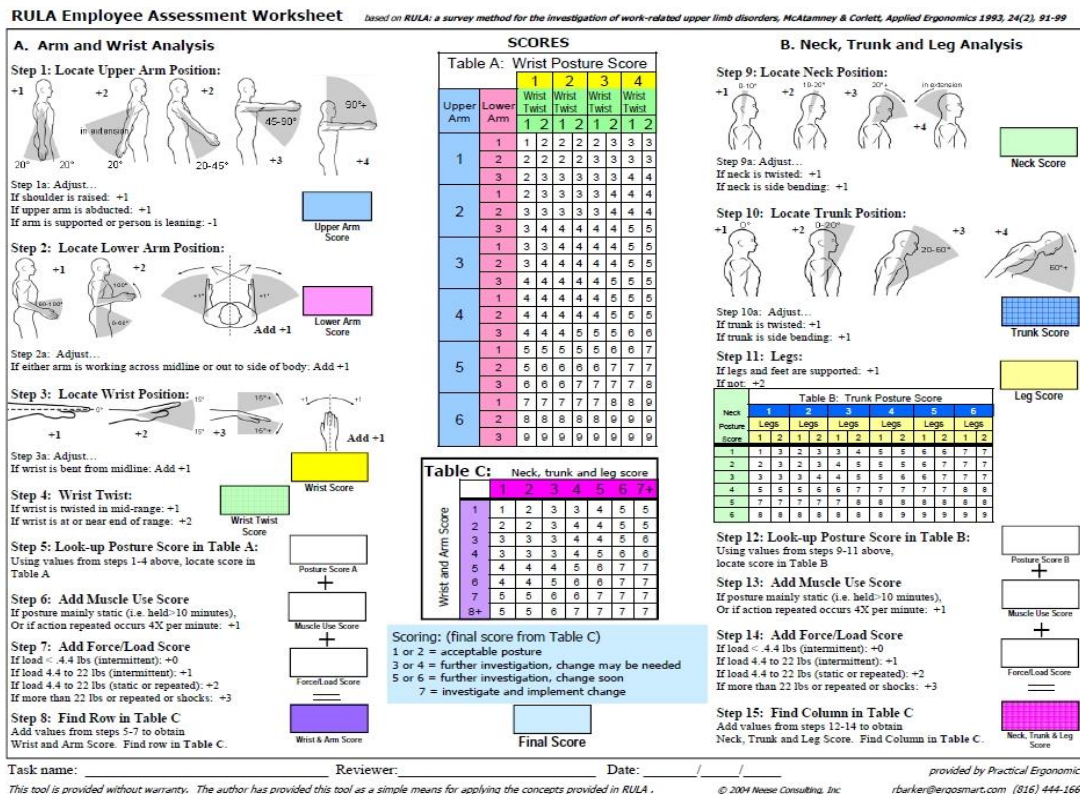

Figure 2. RULA Employee Assessment Work Sheet [31]

The results have the characteristics of a reference guide for taking necessary measures at workplace [32].

Through the RULA Analysis, it is aimed to;

- Present a rapid screening method to mitigate the possible risks of upper limb disorders in relation to the works performed;
- Determine the muscle strains arising based on the standing posture, load being applied and the static and repeated works;

Ensure to obtain results that could be included in a much more sophisticated ergonomics assessment that would cover, too, epidemiologic, physical, cognitive, environmental and organisational factors.

### 3.3 Digital Human Modelling (DHM)

Digital Human Modelling is an approach in which the ergonomic dimensions could be considered at the very early stages of the design developed and an idea could be obtained on how the end user would be affected by the design [33]. It is quite popular study field in recent years, used by many product development units [34, 35]. Digital human modelling techniques have been developed to assist in design and evaluation for a certain labour population. Apart from that, it enables 3D visualisation of the human beings, ergonomic analysis and design of work stations (Figure 3).

DHM, in simple terms, is a design of a human being and the models used are anthropometric. That is, they are visual models having specific abilities and limitations. It is possible to list the features of a suitable DHM as follows [36];

- Inner structure should be able to mimic the human skeleton,
- It should be able to move like a human being and be positioned into real human postures,
- It should be organised in accordance with the data of the society of the anthropometric data will be used,
- It should be able to be integrated into other software.

In order to enhance the applicability of the DHM, a data base for the human movements were obtained through HUMOSIM – Human Motion Simulation - Project and this project is extremely significant for the accuracy of the analyses [37, 38]. With DHM, it is possible to carry out applications and assessments in a wide range from postures and movements to joint angles on a CAD software. DHM has positive impacts on design and production processes in terms of cost effectiveness. It provides engineers with the opportunity to assess ergonomics and human factors at the start of the product development stage. At the same time, it reduces the need for real prototypes.

Enterprises, prior to obtaining a prototype, evaluate designs suitable for users with different characteristics in terms of ergonomic measurements and decide on the best design in this method [39].

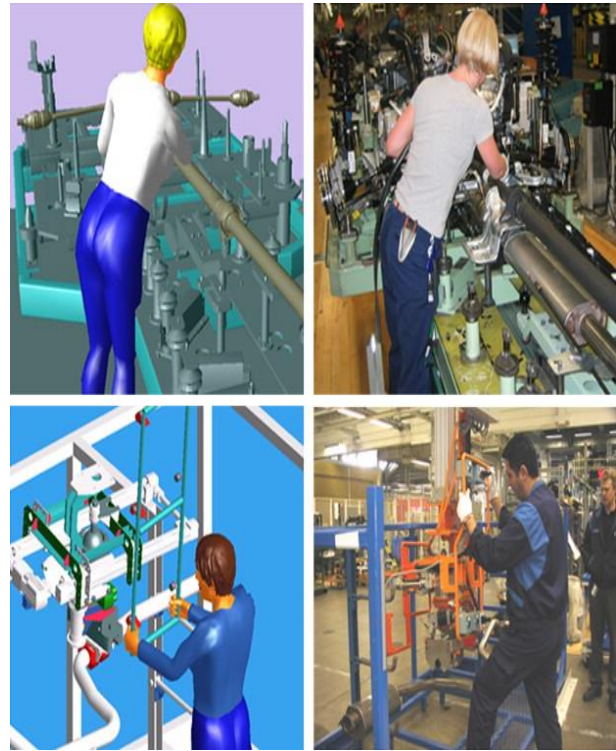
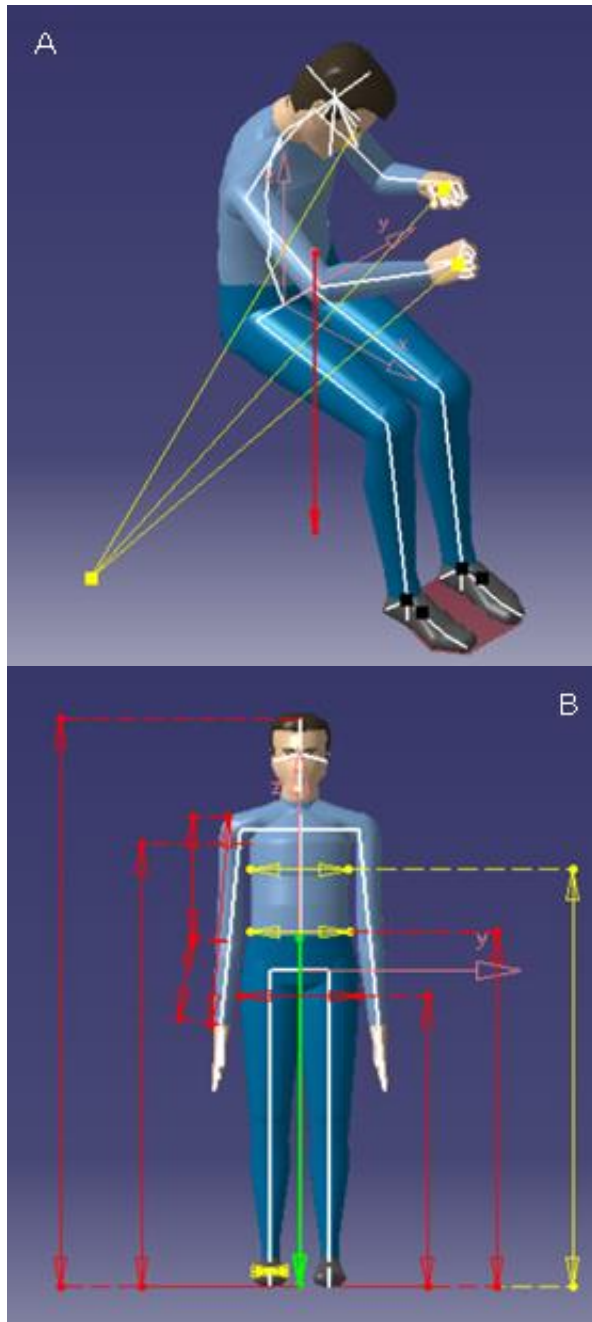

Figure 3. A sample for Digital Human Modelling [40].

As it is not required to take measurements on a user directly on a design carried out through DHM, it provides engineers with the opportunity think about the design and make modifications from the start of the design to the completion [41]. With these characteristics, Digital Human Modelling is rapidly becoming an effective tool for ergonomics analysis and design. With the ergonomic design & analysis module of CATIA, digital human models in desired sizes (DHM-Manikins) can be created and this manikin can be positioned in any working posture (Figure 4). Therefore, the angles of the joints on the manikin's posture can be digitally measured and thus be used in ergonomic analysis methods such as RULA. With the RULA ergonomic analysis calculation tool available within CATIA ergonomic analysis module, RULA analysis stages can be finalised with the hit of a button. This is actually useful in evaluation of the risk at a workplace as well as amount of ergonomic risks in a design. An ergonomic analysis that is run simultaneously with the design would gain the designer speed and accuracy.





**Figure 4.** (A) Working Posture (B) Digital Human Model created for the anthropometric measurements (Manikin).

## 4. RESEARCH AND EXPERIMENTAL DESIGN

### 4.1 Field Research

A research / implementation was carried out on 234 numbers of 7 and 8 grade students in Ipekyolu province of the city of Van in Turkey for the purposes of this study.

The students participated in the study were informed about the study and the measurements to be conducted. Anthropometric data of the students were collected first in the study. Then these data were organized and average anthropometric data belonging to the students were obtained. In the light of the average values obtained, a 3D model of the student desk and the chair was created on a computer. Computer-supported ergonomic analysis of the model was conducted and ergonomically suitability of the desk and the chair for the user was tested. RULA method was used for testing. For the testing and the analysis, Digital Human Models matching the anthropometric measurements obtained as a result of the researches made were used. CATIA V5 software was used for testing, analysis and modelling of these processes. Anthropometric data were collected in January 2017.

Free measurement technique was used in the collection of the anthropometric data as it was economic and practical. It was paid attention that the students participated in the study had no disabilities. Prior to taking measurements, the measuring equipment were calibrated. While taking measurements the students were cared to be as little dressed as possible. First the heights and weights of the participants were measured. Following the measuring of height and weight, the elbow – palm breadth, breadth between elbows, popliteal heights, upper body height, shoulder height, knee height, width of seating area and the depth of seating area of the participants in a static position were measured by means of a steel tape measure. The anthropometric measurements carried out were registered in a data sheet separately for each classroom.

The data recorded in the data collection form were transferred to a digital analysis software. Minimum, average and maximum values of the data transferred to the digital analysis software were taken. With the data obtained, tables and graphs were created.

The study was carried out with 234 Grade 7 and 8 students. Male students constituted %43 of the participant students and female students %57.

Anthropometric data for the participants were recorded in the anthropometric measurement data form given in Table 2 to show the minimum, average and maximum values.

**Table 2.** Anthropometric Measurement Data

ŞEHİT KEMAL GÖRGÜLÜ SECONDARY SCHOOL*		ANTHROPOMETRIC DATA OBTAINED FROM PARTICIPANTS			
S. N.	Anthropometric Measurements Used in Study	Classroom	MIN.	AVE.	MAX.
1	Weight (Kg)	Grade 7	34,2	41,6	58,3
		Grade 8	34,8	53,3	67,1
2	Height (cm)	Grade 7	137	148,1	169
		Grade 8	143	161,1	170
3	Elbow – Palm Breadth (cm)	Grade 7	18	26,2	37
		Grade 8	23	32,9	38
4	Breadth Between Elbows (cm)	Grade 7	29	33,7	46
		Grade 8	26	38,4	50
5	Popliteal Height (cm)	Grade 7	31	38,4	42
		Grade 8	37	43,5	49
6	Upper Body Height (cm)	Grade 7	68	76,4	93
		Grade 8	74	83,5	94
7	Shoulder Height (cm)	Grade 7	49	54,2	64
		Grade 8	49	59,4	70
8	Knee Height (cm)	Grade 7	37	46,7	57
		Grade 8	43	53,1	58
9	Width of Seating Area (cm)	Grade 7	21	29,8	40
		Grade 8	22	35,5	43
10	Depth of Seating Area (cm)	Grade 7	27	38,2	50
		Grade 8	33	45,2	51

As per the anthropometric measurement data given in Table 2, average weight of the participants in Grade 7 is 41,6 kg and that of the ones in Grade 8 is 53,3 kg and general average weight of the participants is 47,5 kg. As per the anthropometric measurements, average height of the participants in Grade 7 is 148,1 cm and that of the ones in Grade 8 is 161,1 cm and general average height of the participants is 154,6 cm.

When all of the anthropometric measurement data in Table 2 are considered, it is seen that while the difference between the measurements of the male and female

students is little, the female students have smaller measurements.

Design of the chair was carried out using the average anthropometric measurement data. In the design, the anthropometric measurements of the students were synchronised with the dimensions of the chair. In Figure 5, draft and 3D models of the student desk and chair designed. In Figure 6, technical drawings and 3D models of the student chair designed are shown.

#### 4.2 Design of Adjustable School Furniture

In this class, the students are expected to turn their studies into drawings, models or products. Therefore, the chairs

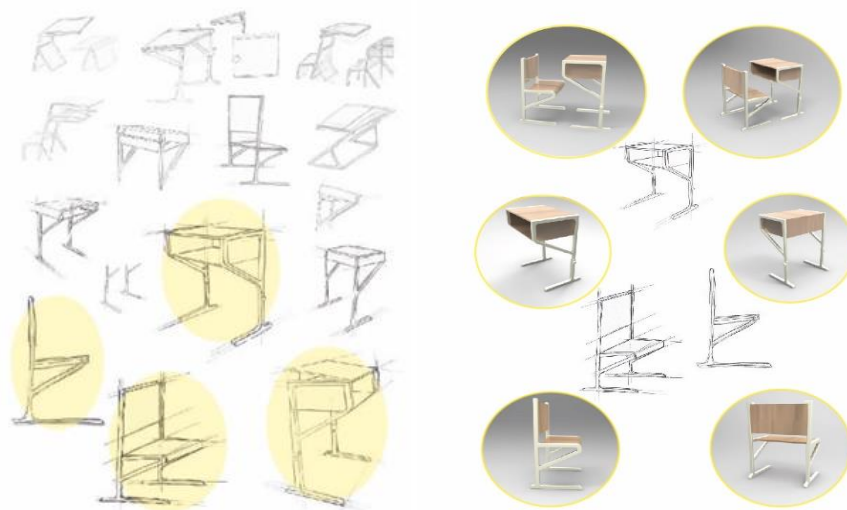

**Figure 5.** 3D Single Desk and Chair Drawings designed for Technology and sketch studies

and desk on which the students carry out their studies should be suitable for the anthropometries of the students as well as for making drawings, models and products.

Through the anthropometric measurement study conducted, a 3D desk and chair design was created on a computer software considering the requirements of the Technology and Design class. When determining the dimensions of the desk and the chair, average anthropometric measurement data were used. As the practices in technology and design classes are carried out individually, the desk and the chair were designed to be a single set to enable students to perform their studies without disturbing each other (Figure 5).

When all of the anthropometric measurement data in Table 2 are considered, it is seen that while the difference between the measurements of the male and female students is little, the female students have smaller measurements.

Design of the chair was carried out using the average anthropometric measurement data. In the design, the anthropometric measurements of the students were synchronised with the dimensions of the chair. In Figure 5, draft and 3D models of the student desk and chair designed. In Figure 6, technical drawings and 3D models of the student chair designed are shown.

#### 4.2 Design of Adjustable School Furniture

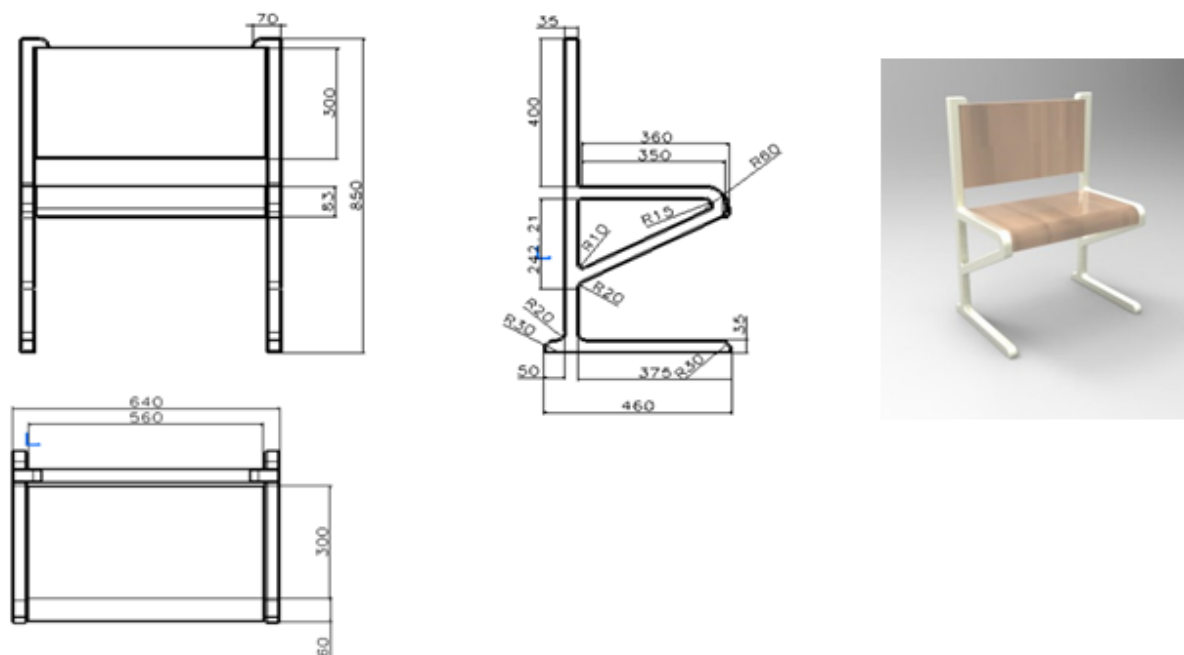

**Figure 6.** Student Chair Technical Drawing and 3D Model

The data recorded in the data collection form were transferred to a digital analysis software. Minimum, average and maximum values of the data transferred to the digital analysis software were taken. With the data obtained, tables and graphs were created.

The study was carried out with 234 Grade 7 and 8 students. Male students constituted %43 of the participant students and female students %57.

Anthropometric data for the participants were recorded in the anthropometric measurement data form given in Table 2 to show the minimum, average and maximum values.

As per the anthropometric measurement data given in Table 2, average weight of the participants in Grade 7 is 41,6 kg and that of the ones in Grade 8 is 53,3 kg and general average weight of the participants is 47,5 kg. As per the anthropometric measurements, average height of the participants in Grade 7 is 148,1 cm and that of the ones in Grade 8 is 161,1 cm and general average height of the participants is 154,6 cm.

In this class, the students are expected to turn their studies into drawings, models or products. Therefore, the chairs and desk on which the students carry out their studies should be suitable for the anthropometries of the students as well as for making drawings, models and products.

Through the anthropometric measurement study conducted, a 3D desk and chair design was created on a computer software considering the requirements of the Technology and Design class. When determining the dimensions of the desk and the chair, average anthropometric measurement data were used. As the practices in technology and design classes are carried out individually, the desk and the chair were designed to be a single set to enable students to perform their studies without disturbing each other (Figure 5).

In design of the desk, anthropometric measurement data obtained during the study and requirements of the technology and design class were taken into account. In that respect, a model of the desk of which the table-top and the skeleton was dynamic was developed (Figure 7).

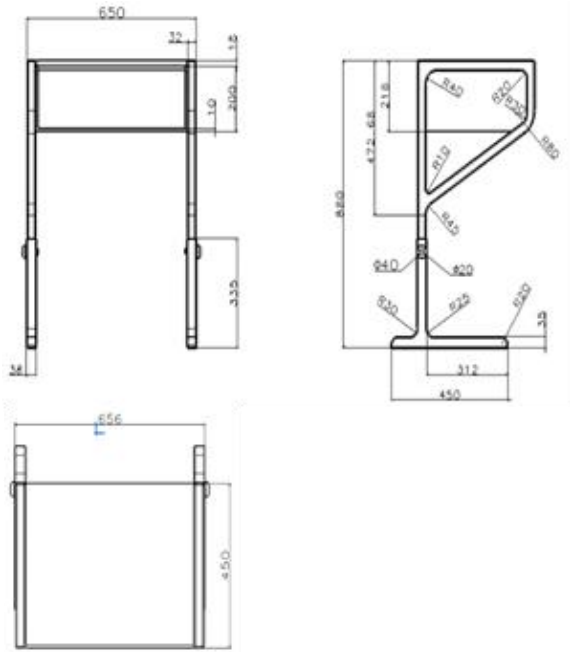

**Figure 7.** Student Desk Technical Drawing and 3D Model



The dynamic desk design makes it possible to control the inclination of the table-top. With the design of a dynamic table-top, it was aimed to enable students to make their drawings and practices maintaining their postures. The dynamic table-top enables students to make drawings in a much more convenient manner (Figure 8).

**Figure 8.** Dynamic Table-Top Design



In the design of the desk, apart from the dynamic table-top, a 3-position height adjustment system that gives students to adjust desk height to their postures was also developed. The 3-position height adjustment system makes it possible for the student to study in a seated or standing position without breaking their postures (Figure 9).

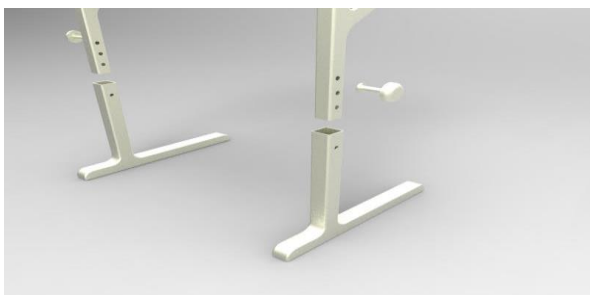

**Figure 9.** Three-Position Height Adjustment System

## 5. RESULTS and DISCUSSION

The CATIA software provides a digital medium for the digitally modelling of the working postures of the workers and yet again for the ergonomic analysis of these working postures via RULA method. As it is with the RULA Method, determination of the postures is essential in many ergonomic analysis methods.

The child manikin developed in accordance with the anthropometric data obtained as part of the field studies was developed in CATIA ergonomic analysis module and then was seated on the chair in a writing position (Figure 10). With a purpose to comparatively observe the ergonomics of the student desk and the chair designed, analyses were carried out for the student chair in two different positions. In the first position the table-top was aligned flat (0 degrees) and in the second position it was inclined in a 15 degree angle, then the manikin was seated in the chair the analyses were performed. The student chair was designed to be suitable for working in both positions.

### 5.1. Case 1: Classic School Furniture

Firstly, an analysis was carried out with the table-top flat (0 Degree) and the manikin in writing position (Figure

Posture of the fore arm and the wrist in the writing position affected the ergonomics.

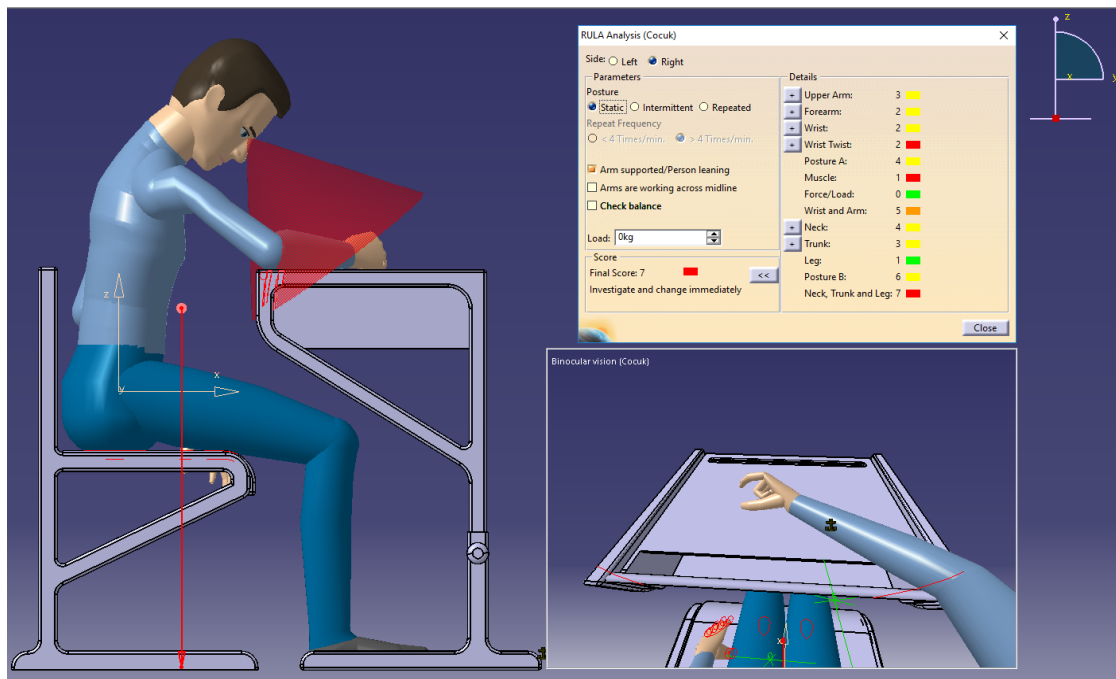

**Figure 10.** Demonstration of Chair Design and Results of RULA Analysis in CATIA Software

10). This position is suitable for design of conventional school chairs. Therefore, the analysis to be carried out would give out the ergonomics score of the conventional student chairs. Then, data such as posture, load borne by the limbs, frequency of the moves and the directions were recorded in relevant sections of the RULA tool. In RULA analysis tool, while it is possible to determine which side of the manikin performing the move is to be assessed, and whether the posture is static, intermittently moving or continuously repeated, the arm support, working area of the arm and the load applied can also be selected. As the child was a right-handed one, right side was chosen and that was the first option. As the move was less than 4 times a minute, “intermittent” option was selected. Arm support was added and the load was specified to be zero. Under these circumstances, the RULA final score was 7. As seen in Figure 10 as well, limbs with ergonomic postures were shown in green and the limbs that disturb the ergonomics were shown in colours other than green. As the ergonomics gets disturbed, the green colour turns into yellow, orange colour and red at the end. The upper arm, fore arm, the wrist, wrist twist, wrist and the arm and dependent on these, the A Score was shown in Yellow to indicate that an ergonomic correction was needed. In this working position, the muscles, load applied, the neck and the lower back are under serious ergonomic risk. This is also reflected in Score B, as well. It was seen the the posture of upper arm and the wrist affected the score most greatly (Table 3). In the first position RULA score was 7. This situation bears considerable amount of ergonomic risks.

### 5.2 Case 2: Adjustable School Furniture

In the second scenario (Case 2), the table-top being flat was inclined by an angle of 15 degrees (Figure 11). On the conditions that the load, repeat of moves and the seating posture would remain the same, only the fore arm was aligned with the table-top. With the new posture of the fore arm, it was seen that the torsion and the twisting in the shoulder and upper arm of the manikin were lessened. With the reducing of the Score of the upper arm, the Score A of the arm and the wrist was also decreased (Figure 11).

Score B was also enhanced compared to Case 1. The design was enhanced thanks to the ability to make instant ergonomic analysis (Table 3). While the muscles and the loads applied in Case 2 are same as that of Case 1, significant enhancements were monitored in scores of wrist and arm as well as neck and body. This was reflected in the Score B. In Case 2, RULA score was 3. This score means a lower ergonomic risk. Comparative ergonomic analysis results showed that the school furniture designed as part of the study could provide better ergonomic study environment compared to the conventional school furniture.

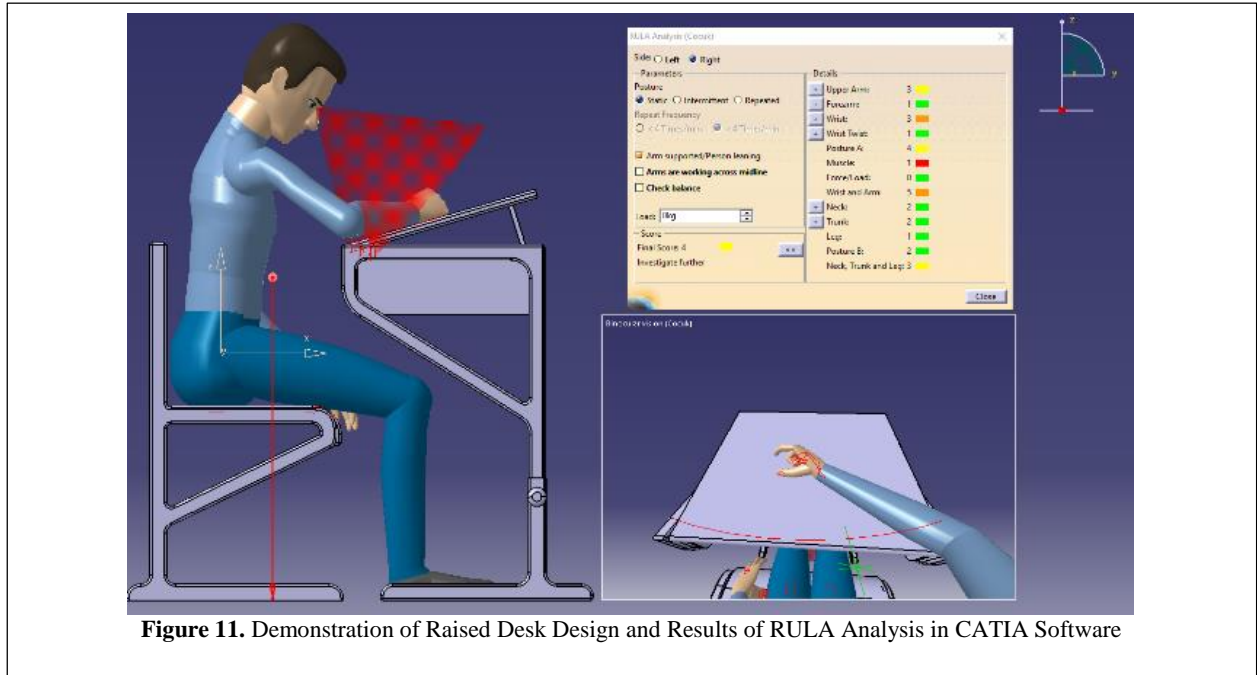

Figure 11. Demonstration of Raised Desk Design and Results of RULA Analysis in CATIA Software

Table 3. Scores' Of Case 1 And Case 2

	Case 1	Case 2
Upper Arm	3	2
Fore Arm	2	2
Wrist	2	2
Wrist Twist	2	1
Posture A	4	3
Muscle	1	1
Force / Load	0	0
Wrist and Arm	5	3
Neck	4	2
Trunk	3	2
Leg	1	1
Posture B	6	2
Neck, Trunk and Leg	7	2
Final Score	7	3

## 6. CONCLUSION

In the studies in literature, it was seen that a majority of the desks and chairs used in existing primary and secondary schools are not suitable for the anthropometric measurements of the students. This is no different in Turkey, either. It was that the desks and chairs used in Turkey were produced taking into account the German or British measurements or produced with no consideration of anthropometric measurements, at all.

The fact that the study was performed in DHM approach, provided monitoring of the effects of the design on the user in a digital medium and provided researchers with the opportunity to think and make amendments on the design. Through the RULA analysis, all anatomic effects of the design on the user were seen and it was decided whether the design needed enhancements or not. DHM approach and the RULA analysis provided researchers

with advantages in terms of time and cost. There were small deviations in the measurements. This is mainly due to the fact that length measurements are made with hand tools, not digital devices.

The ergonomic analysis carried out demonstrated that the desk and the chair designed as a result of the anthropometric data were suitable for the use of the Grade 7 and 8 Students. It was seen that the dynamic table-top of which the inclination was controlled was ergonomically suitable as long as the students maintain their postures. With these school furniture of which the 3D modelling and ergonomic analysis were carried out, it is envisaged that students would experience a comfortable, easy and healthy design process in Technology and Design classes by maintaining their postures.

In future studies, a general study can be conducted by selecting children of the same age level from different regions of the country. Digital measuring devices can be used in the works. In those studies, the use of DHM and RULA will be very advantageous in terms of time and cost. More functional row and table design can be realized. The table top should be able to be used in several different angles. Studies can intensify in this direction.

## DECLARATION OF ETHICAL STANDARDS

The author(s) of this article declare that the materials and methods used in this study do not require ethical committee permission and/or legal-special permission..

## REFERENCES

- [1] Aydın G., Balım AG. "Yapılandırıcı yaklaşıma göre modellendirilmiş disiplinler arası uygulama: enerji konularının öğretimi", *Ankara Üniversitesi Eğitim Bilimleri Fakültesi Dergisi*, 38(2), 145-166.

- [2] Yeats B. "Factors that may influence the postural health of schoolchildren (K12)", *Work*, 9: 45-55, (1997).
- [3] Açıık E., Kayıhan H., Aran, OT. "Investigation of anthropometric suitability of school furniture in primary schools-a pilot study", *Journal of Occupational Therapy and Rehabilitation*, 2: 131-140, (2014).
- [4] Sarı Mİ, Şahin İ., Eldem C., Kiraz C., Şahin T. 2017. "A new ergonomic school furniture design for technology and design teaching", *1st International Turkish World Engineering and Science Congress*, Antalya, Turkey, 245-253, (2017).
- [5] Akın G., Gültekin T., Bektaş Y., Önal S., Tuncel E. "Sequence design for the university students", *DTCF Journal*, 54: 269-286, (2014).
- [6] Bendak S., Al-Saleh K., Al-Khalidi A. "Ergonomic assessment of primary school furniture in united arab emirates", *Occupational Ergonomics*, 11: 85-95, (2013).
- [7] Sigurdsson SO., Artnak M., Needham M., Wirth O., Silverman K. "Motivating ergonomic computer workstation setup: sometimes training is not enough", *International Journal of Occupational Safety and Ergonomics*, 18: 27-33, (2012).
- [8] Burgess-Limerick R., Plooy A., Ankrum D. "The influence of computer display height on head and neck posture1", *International Journal Of Industrial Ergonomics*, 23: 171-179, (1999).
- [9] Taifa IW., Desai DA. "Anthropometric measurements for ergonomic design of students' furniture in India", *Engineering Science and Technology, an International Journal*, 20: 232-239, (2017).
- [10] Oyewole SA., Haight JM., Freivalds A. "The ergonomic design of classroom furniture/computer work station for first graders in the elementary school", *International Journal of Industrial Ergonomics*, 40: 437-447, (2010).
- [11] Knight G., Noyes JAN. "Children's behaviour and the design of school furniture", *Ergonomics*, 42: 747-760, (1999).
- [12] Castellucci HI., Arezes PM., Viviani CA. "Mismatch between classroom furniture and anthropometric measures in Chilean schools", *Applied ergonomics*, 41: 563-568, (2010).
- [13] Castellucci HI., Arezes PM., Molenbroek JFM. "Applying different equations to evaluate the level of mismatch between students and school furniture", *Applied ergonomics*, 45: 1123-1132, (2014).
- [14] Castellucci HI., Arezes PM., Molenbroek JFM. "Equations for defining the mismatch between students and school furniture: A systematic review", *International Journal of Industrial Ergonomics*, 48: 117-126, (2015).
- [15] Agha SR., Alnahhal MJ. "Neural network and multiple linear regression to predict school children dimensions for ergonomic school furniture design", *Applied ergonomics*, 43: 979-984, (2012)..
- [16] Castellucci HI., Arezes PM., Molenbroek JFM., De Bruin R., Viviani C. "The influence of school furniture on students' performance and physical responses: results of a systematic review", *Ergonomics*, 60: 93-110, (2017).
- [17] Saarni LA., Rimpelä AH., Nummi TH., Kaukiainen A., Salminen JJ., Nygård CH. "Do ergonomically designed school workstations decrease musculoskeletal symptoms in children? A 26-month prospective follow-up study", *Applied ergonomics*, 40: 491-499, (2009).
- [18] Hoque ASM., Parvez MS., Halder PK., Szecsi T. "Ergonomic design of classroom furniture for university students of Bangladesh", *Journal of Industrial and Production Engineering*, 31, 239-252, (2014).
- [19] ISO 5970. "Furniture: chairs and tables for educational institutions: functional sizes", *International Organization for Standardization (ISO)*, (1979).
- [20] Lueder R. "The ergonomics payoff: Designing the electronic Office", Nichols Pub Co, New York, (1986).
- [21] Jung HS. "A prototype of an adjustable table and an adjustable chair for schools", *International Journal of Industrial Ergonomics*, 35: 955-969, (2005).
- [22] Url: Kaslar, Çalışmaları ve Antropometri. <http://enm.blogcu.com/kaslar-calismalari-ve-antropometri-5/2661306>, (accessed 23 July 2017).
- [23] Güleç E., Akın G., Sağır M., Koca Özer B., Gültekin T., Bektaş Y. "Anadolu insanının antropometrik boyutları: 2005 yılı Türkiye antropometri anketi genel sonuçları", *Ankara Üniversitesi Dil ve Tarih-Coğrafya Fakültesi Dergisi*, 49, 187-201, (2009).
- [24] Dizdar EN. "Ergonomik iş istasyonu tasarımında ilk adım 'Antropometri'", *Mesleki Sağlık ve Güvenlik Dergisi(MSG)*, 4: 38-44, (2003).
- [25] Güler Ç., Vaizoğlu SA., Tekbaş ÖF. "Temel ergonomi kavramları", *Mesleki Sağlık ve Güvenlik Dergisi(MSG)*, 1: 22-26, (2000).
- [26] Özok AF. "Ergonomik açıdan çalışma yeri düzenleme ve antropometri", Türk Metal Sendikası, Ankara, (1988).
- [27] Şimşek M. "Mühendislikte ergonomik faktörler", *Marmara Üniversitesi Yayınları*, İstanbul, (1994).
- [28] Hertzberg HTE. "Dynamic anthropometry of working positions", *Human Factors*, 2: 147-155, (1960).
- [29] Eldem C., Şahin İ., Demir MT., Top N., Şahin T. "Araç bakım kanallarının dijital insan modelleri ile ergonomik analizi ve yeniden tasarımı", *Mühendislik Bilimleri Ve Tasarım Dergisi*, 7(2): 386-392, (2019).
- [30] Eldem C., Top N., Şahin H. "Dijital insan modelleri kullanılarak otomobil sürücüsü duruş pozisyonlarının ergonomik değerlendirilmesi üzerine bir çalışma", *Gazi Mühendislik Bilimleri Dergisi (GMDB)*, 5(1): 22-31, (2019).
- [31] *RULA Employee Assessment Worksheet*, Neese Consulting Inc., USA, (2004).
- [32] McAtamney L., Corlett EN. "RULA: a survey method for the investigation of work-related upper limb disorders", *Applied Ergonomics*, 24: 91-99, (1993).
- [33] Demirel HO., Duffy VG. "Applications of digital human modeling in industry. In: V. G. Duffy (Ed.)", *Digitalhumanmodeling,Hcii2007,LNCS4561*, 824-832, Berlin, Heidelberg, (2007).
- [34] Faraway J., Reed MP. "Statistics for digital human motion modeling in ergonomics", *Technometrics*, 49: 277-290, (2007).
- [35] Liang MA., Wei Zhang, Huanzhang FU, Yang GUO, Chablat D., Bennis F. "A framework for interactive work design based on digital work analysis and simulation", *Human Factors and Ergonomics in Manufacturing*, 20: 339-352, (2010).
- [36] Dischinger Jr HC. "Digital Human Modeling", *National Aeronautics and Space Administration (NASA)*, USA, (2017).

- [37] Chaffin DB. “On simulating human reach motions for ergonomics analyses”, *Human Factors and Ergonomics in Manufacturing*, 12: 235–247, (2007).
- [38] Chaffin DB. “Human motion simulation for vehicle and workplace design”, *Human Factors and Ergonomics in Manufacturing*, 17: 475–484, (2007).
- [39] Naumann A., Roetting M. “Dijital human modelling for design and evaluation of human-machine systems”, *MMI-Interaktiv*, (2007).
- [40] Lämkuil D., Hanson L., Örtengren R. “A comparative study of digital human modelling simulation results and their outcomes in reality: a case study within manual assembly of automobiles”, *International Journal of Industrial Ergonomics*, 39: 428-441, (2009).
- [41] Chaffin DB. “Improving digital human modelling for proactive ergonomics in design”, *Ergonomics*, 48: 478–491, (2005).