

THE INVESTIGATION OF FATIGUE EFFECT OF LOAD-INDUCED IN STEEL GIRDER BRIDGES

Fatma ÜLKER PEKER (ORCID: 0000-0002-0805-4367)^{1,*}
Ragıp İNCE (ORCID: 0000-0002-9837-8284)²

¹DSİ Genel Müdürlüğü, Proje ve İnşaat Daire Başkanlığı, Yücepepe, Ankara
² Fırat Üniversitesi, Mühendislik Fakültesi, İnşaat Mühendisliği Bölümü, 23119, Elazığ

Geliş / Received: 15.10.2019
Kabul / Accepted: 28.11.2019

ABSTRACT

Fatigue is an important design state affecting the safety of the structure. Due to the cyclical effect of vehicle load, fatigue-induced structural cracks occur in the connection details of steel girders. If the necessary measures are not taken against these cracks; the cracks grow and as a result the structural elements become unstable, it can not carry the internal forces and lose their function. The AASHTO Bridge Design Specification classifies fatigue as load- dependent and distortion-dependent in steel girder bridges and in order to ensure fatigue safety, it is aimed to prevent or minimize the formation of cracks in structural elements. In load-induced fatigue investigation; load and stress limits are taken into account in structural elements to prevent fatigue cracks and fatigue safety is checked for the appropriate connection detail category. In this study, a three-span steel girder bridge was analyzed under fatigue loads with CSiBridge package program. In the analysis, fatigue design properties of AASHTO Specification were used. According to the results of the analysis, it has been proved that the structure is safe from fatigue considering the appropriate fatigue category.

Keywords: steel bridge, composite girder, fatigue, fatigue analysis

ÇELİK KİRİŞLİ KÖPRÜLERDE YÜKE BAĞLI YORULMA ETKİSİNİN İNCELENMESİ

ÖZ

Yorulma, yapının güvenliğine etki eden önemli bir tasarım durumudur. Araç yükünün döngüsel etkisinden dolayı çelik kirişlerin bağlantı detaylarında yorulma kaynaklı yapısal çatlaklar oluşmakta, bu çatlaklara karşı gerekli tedbirler alınmazsa çatlaklar büyümekte ve sonuçta yapısal elemanlar iç kuvvetleri taşıyamayan kararsız bir duruma gelip fonksiyonunu yitirmektedir. AASHTO Köprü Tasarım Şartnamesi çelik kirişli köprülerde yorulmayı yüke bağlı ve distorsiyona bağlı olarak sınıflandırmış, yorulma güvenliğini sağlamak için yapısal elemanlarda çatlak oluşumunu önlemeyi ya da en aza indirmeyi hedeflemiştir. Yüke bağlı yorulma incelemesinde; yorulma çatlaklarının oluşmasını önlemek için yapısal elemanlarda yük ve gerilme sınırları dikkate alınmakta, uygun bağlantı detay kategorisi için yorulma güvenliği kontrol edilmektedir. Bu çalışmada üç açıklıklı çelik kirişli bir köprü CSiBridge paket programıyla yorulma yükleri altında analiz edilmiştir, analizde AASHTO Şartnamesinde yorulma tasarım özellikleri kullanılmıştır. Analiz sonuçlarına göre yapıda uygun yorulma kategorisi dikkate alınarak yapının yorulma yönünden güvenli olduğu ispat edilmiştir.

Anahtar kelimeler: çelik köprü, kompozit kiriş, yorulma, yorulma analizi

*Corresponding author / Sorumlu yazar. Tel.: 0312 454 5332; e-mail / e-posta: fulker44@gmail.com

1. INTRODUCTION

Cyclic loading is the type of loading that causes cracks in the structure as a result of repeated loads and causes the structure to lose its function as a result of the growth of these cracks. When the structures are classified according to the loading cycle (Fig. 1), it is seen that the bridge structures are of high cyclic loading class. Fatigue causes structural damage that affects the performance of bridges [1-3].

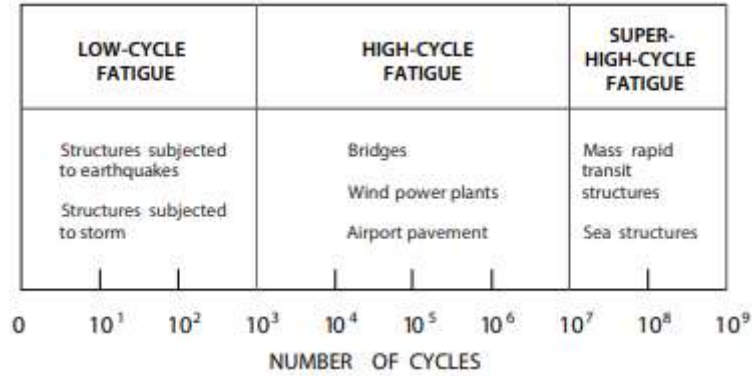

Fig 1. For construction types, fatigue due to cyclic loading conditions [2].

Fatigue-related structural damages in steel girder bridges are crack formation and crack growth. If the necessary structural measures are not taken as a result of these complications, unstable crack growth, ie fracture, is formed and thus cannot function as a bridge. Crack formation and growth are expressed in three different regime regions [4]. These regime regions are as shown in Figure 2, the first region is the crack initiation region, the second region is the crack propagation region for the steady-state and the third region is the fracture region for the unstable state [1-7].

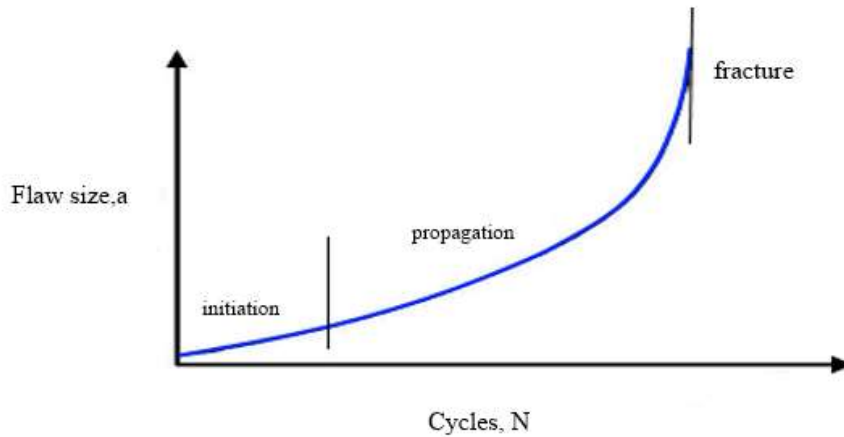

Fig. 2. Crack growth regime regions [4].

Fatigue cracks occur due to load- and distortion-induced. In order to minimize the formation of load-induced fatigue cracks, load and stress limits are taken into account in the structural members. To prevent fatigue cracks due to distortion-induced, suitable detailing applications are used [1, 7- 11]. When the literature is examined, it is determined that the studies related to fatigue are mostly based on experimental research. These studies are generally based on monitoring fatigue cracks, examining fatigue damages and evaluating fatigue safety and some of the studies are summarized below.

Abdi et al. have examined composite military bridges under cyclic fatigue loading [12]. Mori et al. have proposed a new parameter for fatigue life prediction on short and medium span girder highway bridges [13]. Kawakam et al. have examined the application of FSM method which is a non-destructive control method for monitoring fatigue cracks in steel bridges [14]. Fasl et al have examined a probabilistic method for fatigue life estimation of steel bridges using the deformation data measured in their study and applied this method to a

THE INVESTIGATION OF FATIGUE EFFECT OF LOAD-INDUCED IN STEEL GIRDER BRIDGES

critical bridge in terms of fracture [15]. Ye et al. have conducted a general study on the fatigue life of steel bridges, including the basic elements of fatigue, such as classical fatigue analysis methods, data-based fatigue life assessment and reliability-based fatigue status assessment [16]. In his study [17], Sakagami has developed a non-destructive assessment technique using infrared thermal imaging, called NDE technique, to detect fatigue cracks in steel bridges and to assess structural integrity. In their study [18], Zhang and Au have proposed an advanced probabilistic loading model to simulate vehicles crossing bridges based on measurements, taking into account the rate of change in annual traffic. Kong et al. have proposed a strain sensing technology for monitoring fatigue cracks in steel bridges [19]. Kwad et al. have proposed an approach with finite element modeling and area measurements on an old steel bridge and have made fatigue assessment [20]. Sekiya et al. have proposed an imaging system that demonstrated the relationship between displacements and vehicle positions on the bridge [21]. Hasni et al. have examined the detection of fatigue crack in steel bridge girders [22]. Djoković et al. have conducted a study on the prediction of fatigue life of steel bridges by fracture mechanics. [23]. Karunananda et al. have investigated the effect of high amplitude loading on the estimation of fatigue life of steel bridges [24]. Pipinato et al. have used the LEFM (Linear Elastic Fracture Mechanics) approach, a probabilistic approach, in their study [25] to assess fatigue safety under seismic loading on steel girder highway bridges. Macho et al. have conducted a laboratory test to see the effect of corrosion on static and fatigue strength of structural elements in an existing steel bridge [26].

In this study, the fatigue effect of the three-span steel girder bridge, which is widely used in the literature and given in Ref. [11], is examined with CSiBridge package program using 3-D precision solution method [11, 27].

2. MATERIAL AND METHOD

2.1. Load-induced fatigue effect

In bridge structures subject to high cyclic loading due to vehicle load weight effect, fatigue limit state designs defined in AASHTO Bridge Design Specification are applied to ensure the strength of the structure. The fatigue boundary state design is the limitation of the stress range with fatigue strength in each structural component detail of the bridge [1, 10, 11, 28].

According to the AASHTO Design Specification, fatigue investigation is carried out by applying Fatigue I and Fatigue II limit states. In Fatigue I limit state, high traffic density is accepted by the infinite life design approach on the bridge and HL-93F fatigue vehicle is used in calculations. Fatigue I limit state is expressed in eq 1. [1, 10, 11]:

$$(\Delta F)_n = (\Delta F)_{TH} \quad (1)$$

In expression (1), $(\Delta F)_n$ is nominal fatigue resistance, $(\Delta F)_{TH}$ is constant amplitude fatigue threshold taken from AASHTO Table 6.6.1.2.5-3 (this threshold value is determined according to the fatigue detail categories defined by structural connection detail in AASHTO Specification). AASHTO Table 6.6.1.2.3-1 includes fatigue category characteristics in connection details for all steel bridge types. The most common connection detail categories in I-girder bridges are given in Table 1. These detail categories are shown in Fig. 3 on a typical girder. In the load-induced fatigue design, the most common detail types and categories of these connection details for I-girder are checked for fatigue safety [1, 7, 11].

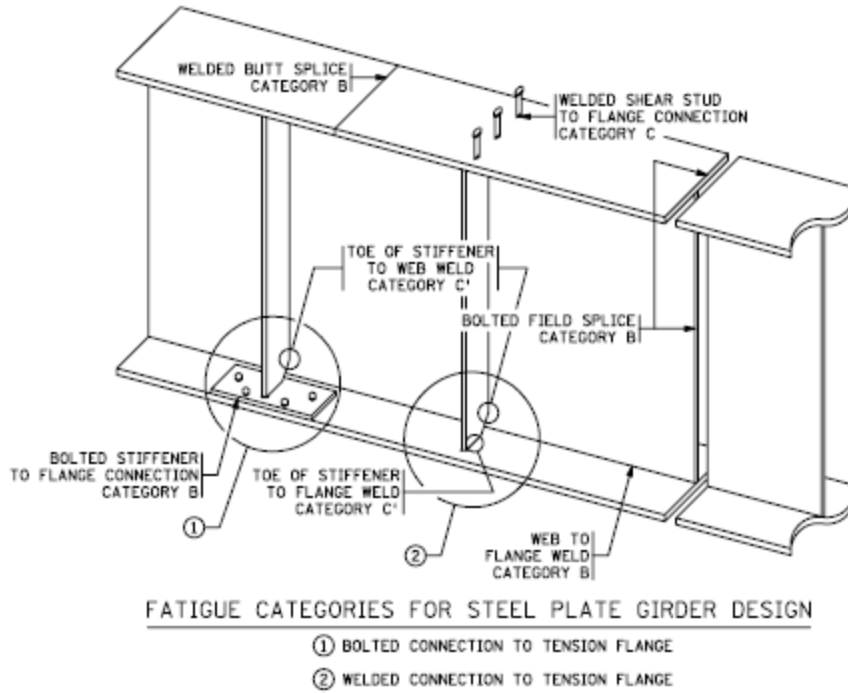

Fig. 3. Fatigue categories for steel girder connection details [7]

Table 1. Fatigue detail categories for steel I-girder [10]

Type of Details	Category
Base metal and weld metal at full penetration groove-welded splices	B
Base metal at gross section of highstrength bolted slip-critical connections (bolt gusset to flange)	B
Base metal at fillet-welded stud- type shear connectors	C
Base metal at toe of transverse stiffener-to-flange and transverse stiffener-to-web welds	C'

Table 2. Characteristic fatigue strengths for detail categories [10]

Detail Category	Constant- A (x 10 ⁸) (ksi ³)	Fatigue II $\Delta F_n = (A/N)^{1/3}$ (ksi)	Fatigue I $\Delta F_n = (\Delta F)_{TH}$ (ksi)
B	120.0	28.37	16.0
C	44.0	20.31	10.0
C'	44.0	20.31	12.0
E	11.0	12.79	4.5

In Fatigue II limit state, the bridge has a finite design life approach, traffic density is considered low and P9 vehicle which is a fatigue design vehicle type is used in calculations. Fatigue II limit state is expressed in eq 2. [1, 10, 11]:

THE INVESTIGATION OF FATIGUE EFFECT OF LOAD-INDUCED IN STEEL GIRDER BRIDGES

$$(\Delta F)_n = \left(\frac{A}{N}\right)^{\frac{1}{3}} \tag{2}$$

In expression (2), $(\Delta F)_n$ is nominal fatigue resistance (Table 2), A is constant value dependent on the detail category taken from AASHTO LRFD Table 6.6.1.2.5-1, n refers to the number of cycles of the stress range per truck pass taken from AASHTO LRFD Table 6.6.1.2.5-2. N is the number of cycles of the stress range and is expressed by the eq 3. [1, 10, 11]:

$$N = (365)(75)n(ADTT)_{SL} \tag{3}$$

In expression (3), $(ADTT)_{SL}$ refers to the average daily truck traffic for a single lane during the design life on the bridge. This value is taken as 2500 for Fatigue I limit state and 20 for Fatigue II limit state in calculations [10, 11]. Number of cycles in the stress range is limited is to the minimum number of stress cycles (N_{TH}) corresponding to the constant amplitude fatigue threshold. N_{TH} is expressed in eq 4. [1, 10]:

$$N_{TH} = \frac{A}{[(\Delta F)_{TH}]^3} \tag{4}$$

The relationship between fatigue strength and the number of cycles of stress range per truck pass depending on fatigue boundary state design is shown graphically in Fig. 4. On the bridge, the number of cycles of stress range due to vehicle passage increases up to the constant amplitude fatigue threshold ($N < N_{TH}$), whereas fatigue strength decreases. This is the design acceptance of the finite bridge life. In the infinite bridge life design, the number of stress range cycles is above the fatigue threshold ($N > N_{TH}$) and fatigue strength is considered to be constant [1, 10].

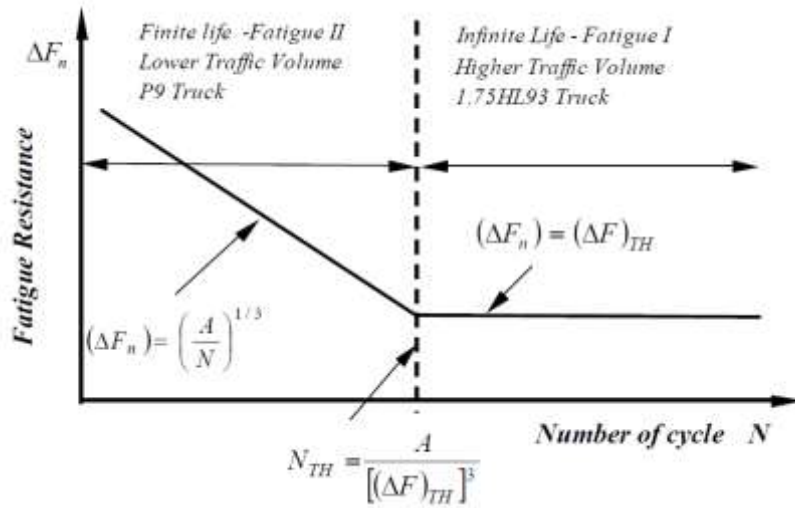

Fig. 4. Relationship between fatigue strength and number of cycles [10].

2.2. Fatigue analysis with CSiBRIDGE package program

Fatigue analysis of three span composite steel I-girder bridge is performed in CSiBridge program in this study. In fatigue analysis, Fatigue I and Fatigue II limit state conditions are taken into consideration and HL-93F and P9 fatigue vehicles are used in the analysis. The design features of these vehicles are included in the program by default. In the crossing of fatigue vehicles, the dynamic load allowance is applied as 1.15 for both vehicles. In addition, only axle weights of the vehicle are taken into account in the analysis since there is a single vehicle

transition acceptance approach in the crossing of fatigue vehicles; lane load is not used in the calculations. The design features of the bridge are given in Figure 5.

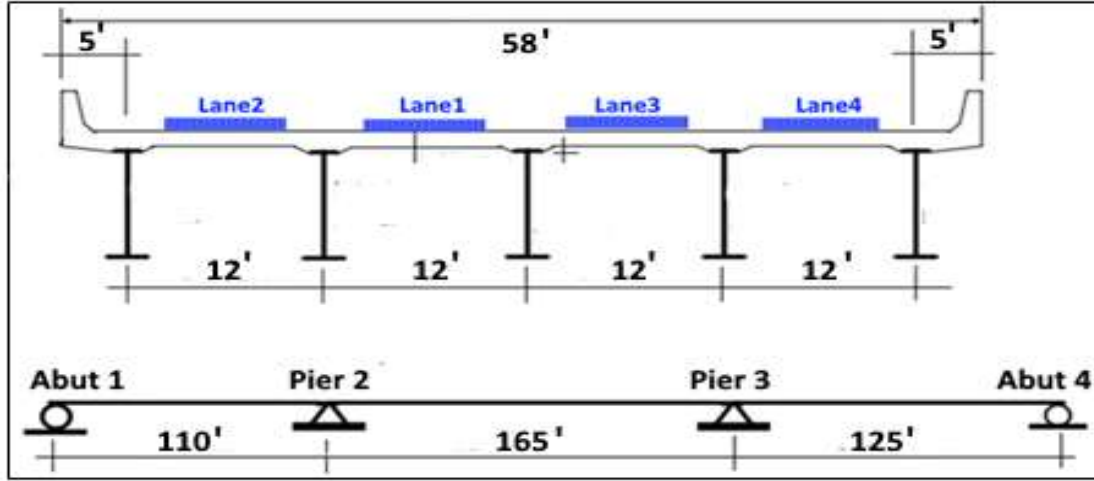

Fig. 5. Example of steel I-girder bridge [11].

The bridge is modeled as 110-165-125 ft long and 20 degree skew from the axis in CSiBridge. There are 5 steel girders on this bridge: 3 interior and 3 exterior. According to the span feature on the bridge; there are road lanes, these lanes are Lane 1, Lane 2, Lane 3 and Lane 4. This modeled bridge is shown in Figure 6.

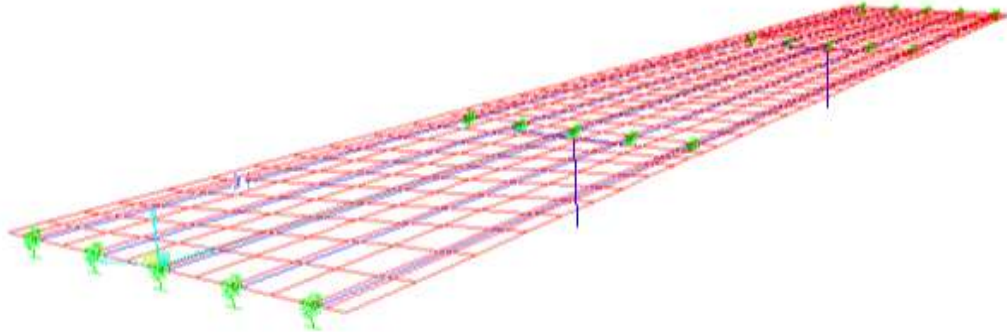

Fig. 6. Modeling of the three span steel I-girder bridge with CSiBridge.

In fatigue analysis, a single design lane is considered. Fatigue inspection is carried out for the interior girder; so in the design loading, the loaded lane is taken as Lane 2. According to the analysis results, Fatigue I and Fatigue II limit state load combinations of AASHTO Design Specification are applied for fatigue assessment. These load combinations are expressed in eq 5. and eq. 6. [11]:

$$\text{Fatigue I: } 1.5(DF)(LL+IM)_{HL-93} \quad (5)$$

$$\text{Fatigue II: } 0.75(DF)(LL+IM)_{P-9} \quad (6)$$

In these expressions, (LL + IM) is the weight effect of vehicle loads and DF is the live load distribution factor. It is assumed that the DF coefficient is included in the calculations by default.

For Fatigue I analysis, HL-93F vehicle is loaded into the structure and the system is analyzed only under vehicle load. Accordingly; force effects are shown in Figure 7, positive moment and negative moment in the middle of the second span are obtained as 1300,83 kip-ft and -211,78 kip-ft.

THE INVESTIGATION OF FATIGUE EFFECT OF LOAD-INDUCED IN STEEL GIRDER BRIDGES

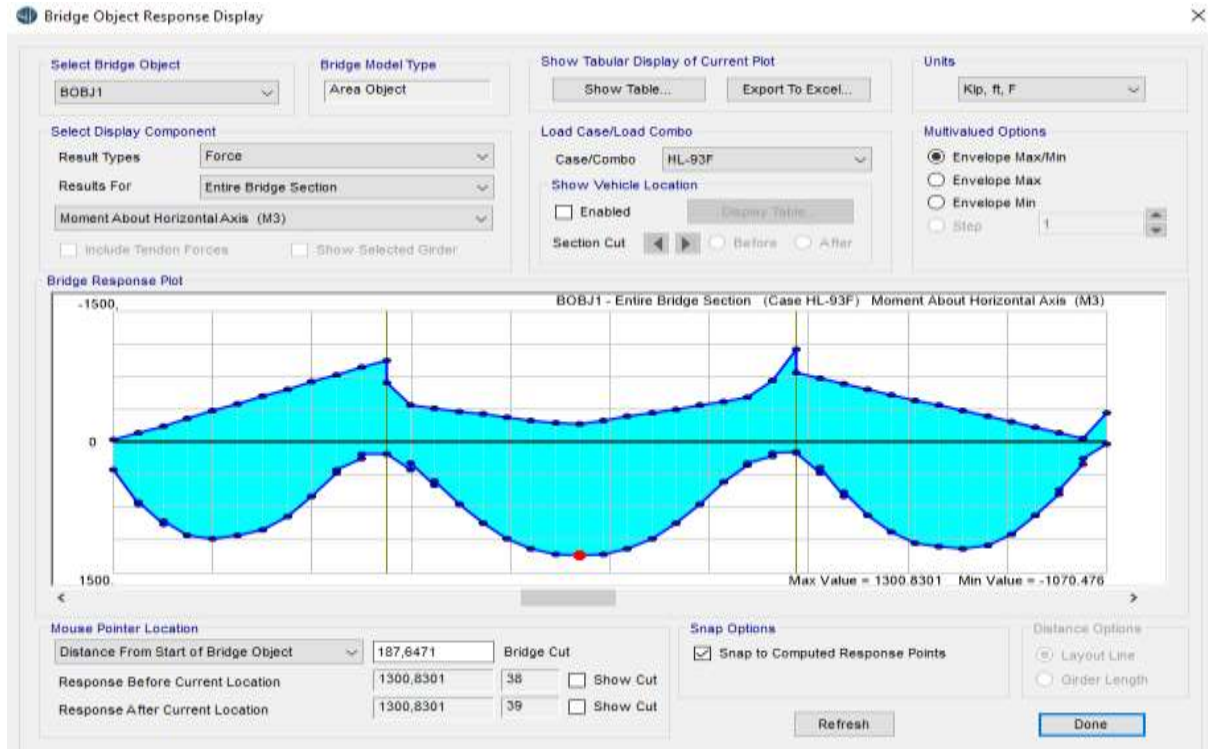

Fig. 7. Moment calculated with CSiBridge due to HL-93F vehicle loading.

For Fatigue-I infinite bridge life, bottom flange design control:

$$(\Delta F)_n = \left| \frac{+M}{S_{STb}} \right| + \left| \frac{-M}{S_{NCb}} \right| = \frac{1300.83(12)}{4,018} + \frac{211,78(12)}{3,200}$$

$$(\Delta F)_n = 4,68 \text{ ksi}$$

Where, S_{STb} and S_{NCb} are short-term and long-term composite elastic section modulus in bottom flange, respectively.

For Category C' $(\Delta F)_{TH} = 12 \text{ ksi}$ (Table 2); $4,68 < 12$ (appropriate for fatigue design)

For Category B $(\Delta F)_{TH} = 16 \text{ ksi}$ (Table 2); $4,68 < 16$ (appropriate for fatigue design)

For Fatigue-I infinite bridge life, top flange design control:

$$(\Delta F)_n = \left| \frac{+M}{S_{STt}} \right| + \left| \frac{-M}{S_{NCt}} \right| = \frac{1300.83(12)}{22,489} + \frac{211,78(12)}{3,380}$$

$$(\Delta F)_n = 1,44 \text{ ksi}$$

Where, S_{STt} and S_{NCt} are short-term and long-term composite elastic section modulus in top flange, respectively.

For Category C $(\Delta F)_{TH} = 10 \text{ ksi}$ (Table 2); $1,44 < 10$ (appropriate for fatigue design)

For Category C' $(\Delta F)_{TH} = 12 \text{ ksi}$ (Table 2); $1,44 < 12$ (appropriate for fatigue design)

For Category B $(\Delta F)_{TH} = 16 \text{ ksi}$ (Table 2); $1,44 < 16$ (appropriate for fatigue design)

F. ÜLKER PEKER, R. İNCE

For Fatigue II analysis, P9 vehicle is loaded into the structure and the system is analyzed only under vehicle load. Accordingly; force effects are shown in Figure 8, positive moment and negative moment in the middle of the second span are obtained as 1740,10 kip-ft and -289,96 kip-ft.

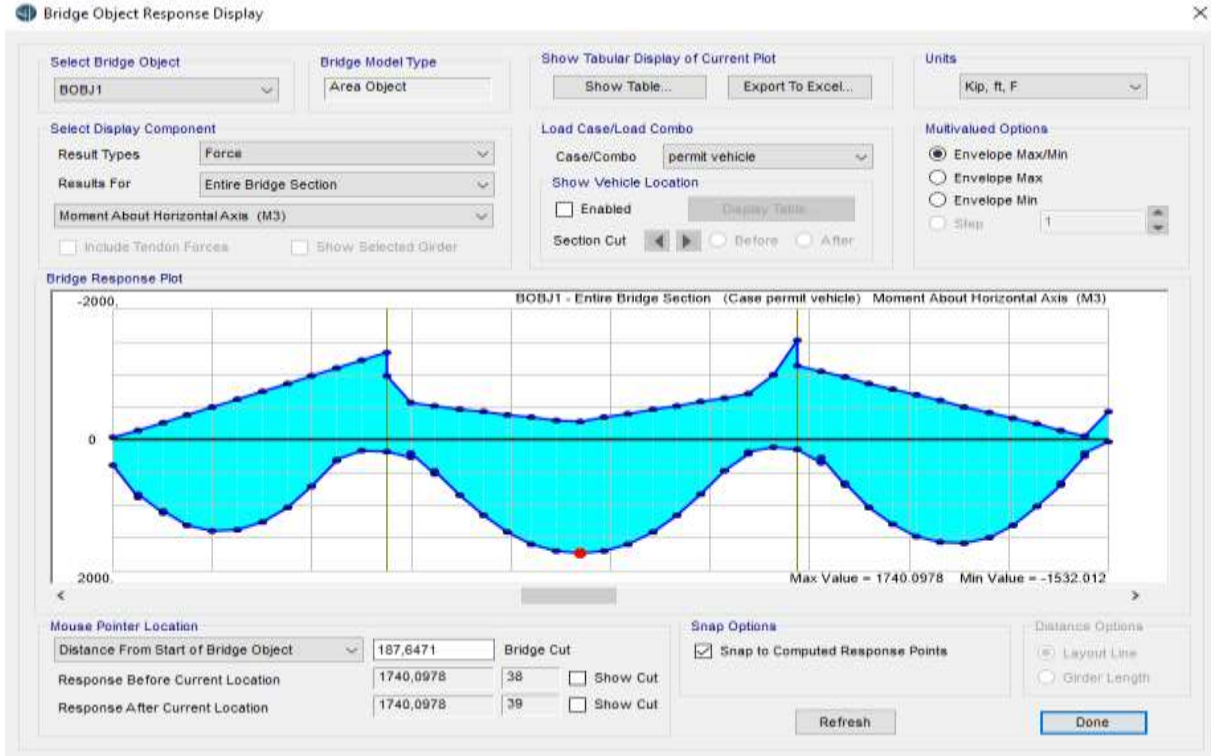

Fig. 8. Moment calculated with CSiBridge due to P9 vehicle loading

For Fatigue-II finite bridge life, bottom flange design control:

$$(\Delta F)_n = \left| \frac{+M}{S_{STb}} \right| + \left| \frac{-M}{S_{NCb}} \right| = \frac{1740,10(12)}{4,018} + \frac{289,96(12)}{3,200}$$

$$(\Delta F)_n = 6,29 \text{ ksi}$$

For Category C' $(\Delta F)_{TH} = 21,58 \text{ ksi}$ (Table 2); $6,29 < 21,58$ (appropriate for fatigue design)

For Category B $(\Delta F)_{TH} = 30,15 \text{ ksi}$ (Table 2); $6,29 < 30,15$ (appropriate for fatigue design)

For Fatigue-II finite bridge life, top flange design control:

$$(\Delta F)_n = \left| \frac{+M}{S_{STt}} \right| + \left| \frac{-M}{S_{NCt}} \right| = \frac{1740,10(12)}{22,489} + \frac{289,96(12)}{3,380}$$

$$(\Delta F)_n = 1,96 \text{ ksi}$$

For Category C $(\Delta F)_{TH} = 21,58 \text{ ksi}$ (Table 2); $1,96 < 21,58$ (appropriate for fatigue design)

For Category C' $(\Delta F)_{TH} = 21,58 \text{ ksi}$ (Table 2); $1,96 < 21,58$ (appropriate for fatigue design)

For Category B $(\Delta F)_{TH} = 30,15 \text{ ksi}$ (Table 2); $1,96 < 30,15$ (appropriate for fatigue design)

*THE INVESTIGATION OF FATIGUE EFFECT OF LOAD-INDUCED IN STEEL GIRDER BRIDGES***3. CONCLUSIONS**

In this study, fatigue analysis of a steel I-girder bridge has been performed by using CSiBridge package program which make precision analysis and according to the results of this analysis, the girder has been found to be safe against cyclic loading in terms of fatigue. Fatigue analysis with Line-girder analysis method of the same bridge is complex, exhausting and time-consuming; with CSiBridge 3D analysis, it is advantageous to achieve precise results in a short time.

The service load of the bridges and the axle weights of the vehicles passing through the bridges are increasing day by day. In this case, it is necessary to ensure continuity of use within the designated design life of the structure without compromising its safety. The continuity of the bridge will be ensured safely by considering the fatigue safety against the load effect in the bridge design and ensuring the fatigue safety against distortion with appropriate detailing applications in bridge construction.

REFERENCES

- [1] AASHTO LRFD Bridge Design Specifications, 6th ed., American Association of State Highway and Transportation Officials, Washington,DC, 2012
- [2] <https://www.structuremag.org/wp-content/uploads/2016/11/D-StrucAnalysis-Khatri-Dec16-1.pdf> (Last Access 10.07.2019)
- [3] MORI, T., LEE, H. H., KYUNG, K. S., “Fatigue Life Estimation Parameter for Short and Medium Span Steel Highway Girder Bridges”, Engineering Structures, 29(10), 2762-2774, 2007.
- [4] <https://www.fhwa.dot.gov/bridge/steel/pubs/if12052/volume12.pdf> (Last Access 10.07.2019)
- [5] <http://saveourbridges.com/basics.html> (Last Access 10.07.2019)
- [6] <http://digitalcommons.unl.edu/cgi/viewcontent.cgi?article=1146&context=ndor> (Last Access 10.07.2019)
- [7] <https://www.dot.state.mn.us/bridge/pdf/lrfdmanual/lrfdbridgedesignmanual.pdf> (Last Access 10.07.2019)
- [8] HAGHANI, R., AL-EMRANI, M., HESHMATI, M., “Fatigue-Prone Details in Steel Bridges”, Buildings, 2(4), 456-476, 2012.
- [9] https://www.researchgate.net/publication/305950405_Need_for_Fatigue_Assessment_of_Steel_Bridges (Last Access 10.07.2019)
- [10] <http://www.dot.ca.gov/des/techpubs/manuals/bridge-design-practice/page/bdp-6.pdf> (Last Access 10.07.2019)
- [11] <http://www.dot.ca.gov/des/techpubs/manuals/bridge-design-practice/page/bdp-9.pdf> (Last Access 18.04.2019)
- [12] ABDI, F., QIAN, Z., MOSALLAM, A., IYER, R., WANG, J. J., LOGAN, T., “Composite Army Bridges under Fatigue Cyclic Loading”, Structure and Infrastructure Engineering, 2(1), 63-73, 2006.
- [13] MORI, T., LEE, H. H., KYUNG, K. S., “Fatigue Life Estimation Parameter for Short and Medium Span Steel Highway Girder Bridges”, Engineering Structures, 29(10), 2762-2774, 2007.
- [14] KAWAKAM, Y., KANAJI, H. AND OKU, K., “Study on Application of Field Signature Method (FSM) to Fatigue Crack Monitoring on Steel Bridges”, Procedia Engineering, 14, 1059-1064, 2011.
- [15] FASL, J., HELWIG, T AND WOOD, S. L., “Probabilistic Method for Estimating Remaining Fatigue Life in Steel Bridges using Measured Strain Data”, Journal of Civil Structural Health Monitoring, 3(4), 317-324, 2013.
- [16] YE, X. W., SU, Y. H. AND HAN, J. P., “A State-Of-The-Art Review on Fatigue Life Assessment of Steel Bridges”, Mathematical Problems in Engineering, 2014.
- [17] SAKAGAMI, T., “Remote Nondestructive Evaluation Technique using Infrared Thermography for Fatigue Cracks in Steel Bridges”, Fatigue & Fracture of Engineering Materials & Structures, 38(7), 755-779, 2015.
- [18] ZHANG, J., AU, F. T. K., “Fatigue Reliability Assessment Considering Traffic Flow Variation Based On Weigh-In-Motion Data”, Advances in Structural Engineering, 20(1), 125-138, 2017.
- [19] KONG, X., LI, J., COLLINS, W., BENNETT, C., LAFLAMME, S., JO, H., “A Large-Area Strain Sensing Technology for Monitoring Fatigue Cracks in Steel Bridges”, Smart Materials and Structures, 26(8), 085024, 2017.

- [20] KWAD, J., ALENCAR, G., CORREIA, J., JESUS, A., CALCADA, R., KRIPAKARAN, P., “Fatigue Assessment of an Existing Steel Bridge by Finite Element Modelling and Field Measurements. in *Journal of Physics: Conference Series*”, 843(1), p 012038, IOP Publishing, 2017.
- [21] SEKIYA, H., MARUYAMA, O., MIKI, C., “Visualization System for Bridge Deformations under Live Load Based on Multipoint Simultaneous Measurements of Displacement and Rotational Response using MEMS Sensors”, *Engineering Structures*, 146, 43-53, 2017.
- [22] HASNI, H., ALAVI, A. H., JIAO, P. AND LAJNEF, N., “Detection of Fatigue Cracking in Steel Bridge Girders: A Support Vector Machine Approach”, *Archives of Civil and Mechanical Engineering*, 17(3), 609-622, 2017.
- [23] DJOKOVIĆ, J. M., NIKOLIĆ, R. R., BUJNÁK, J., HADZIMA, B., “Estimate of The Steel Bridges Fatigue Life by Application of The Fracture Mechanics. In *IOP Conference Series: Materials Science and Engineering*” 419(1), p. 012010, IOP Publishing, 2018.
- [24] KARUNANANDA, K., OHGA, M., DISSANAYAKE, P. B. R., SIRIWARDANE, S., “Effect of High Amplitude Loading on Fatigue Life Prediction of Steel Bridges”, *Procedia Engineering*, 14, 521-528, 2011.
- [25] PIPINATO, A., PELLEGRINO, C., MODENA, C., “Fatigue Assessment of Highway Steel Bridges in Presence of Seismic Loading”, *Engineering Structures*, 33(1), 202-209, 2011.
- [26] MACHO, M., RYJÁČEK, P., MATOS, J. C., “Static and Fatigue Test on Real Steel Bridge Components Deteriorated by Corrosion”, *International Journal of Steel Structures*, 19(1), 110-130, 2019.
- [27] CSiBridge V15-V20, Integrated 3-D Bridge Analysis, Design and Rating, Computers and Structures Inc.
- [28] BARKER, R. M., PUCKETT, J. A., *Design of Highway Bridges: An LRFD Approach*, John Wiley and Sons (3rd ed.), Canada, USA, 2013.